

On the geometry of flip-graphs of orientable surfaces

Hugo Parlier* Lionel Pournin^o

*University of Fribourg

^oUniversité Paris 13

November 6, 2014

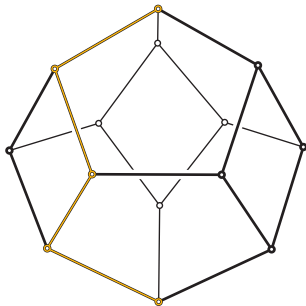

Summary

0. Preliminary definitions

Surfaces, triangulations, and flips.

1. The case of the disc

The diameters of associahedra.

2. Surfaces with 2 or 3 boundaries

Two examples with large flip distances.

3. Maximal Flip distances on more general surfaces

A general upper bound.

4. Conclusions

The diameter of other flip-graphs.

0. Preliminary definitions

Fancy surfaces

Consider an orientable surface of genus g with $r > 0$ boundaries. One of these boundaries will be called the *outer* boundary:

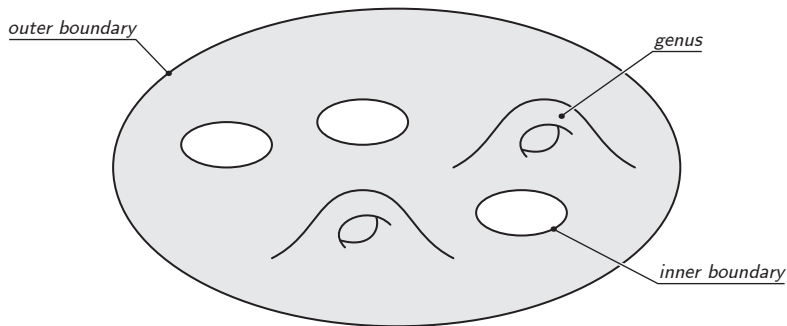

(this is an orientable surface with 4 boundaries and genus 2)

0. Preliminary definitions

Fancy surfaces

Consider n vertices in the outer boundary, labeled 1 to n clockwise, and other vertices in the surface so that every boundary contains at least one vertex. The set of these vertices will be denoted by \mathcal{A} .

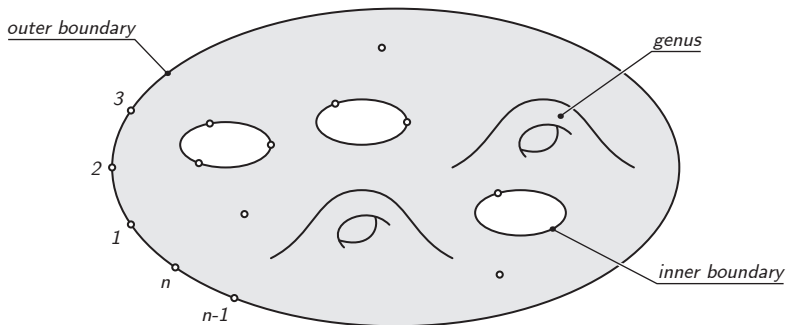

(this is an orientable surface with 4 boundaries and genus 2)

0. Preliminary definitions

Fancy surfaces

Two edges are *isotopic* if they can be continuously deformed into one another. They are non-isotopic if some obstacle lies “between” them (a boundary, a genus, or a vertex). Some edges have only one vertex.

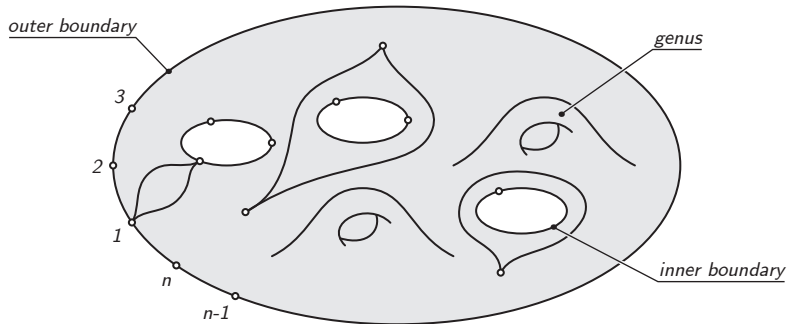

(this is an orientable surface with 4 boundaries and genus 2)

0. Preliminary definitions

Triangulations

Definition

A triangulation of \mathcal{A} is a maximal set of pairwise non-crossing and pairwise non-isotopic edges with vertices in \mathcal{A} .

The edges of a triangulation are considered up to isotopy: they can be deformed under the condition that they remain pairwise non-crossing.

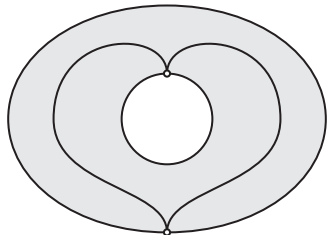

A triangulation of a cylinder with one vertex on each boundary.

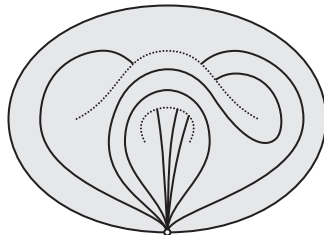

A triangulation of a torus with a boundary containing one vertex.

0. Preliminary definitions

Flips

Let ε be interior edge of a triangulation T of \mathcal{A} that is the diagonal of some quadrilateral q whose boundary edges belong to T .

Definition

Flipping ε in T consists in replacing ε by the other diagonal of q within T .

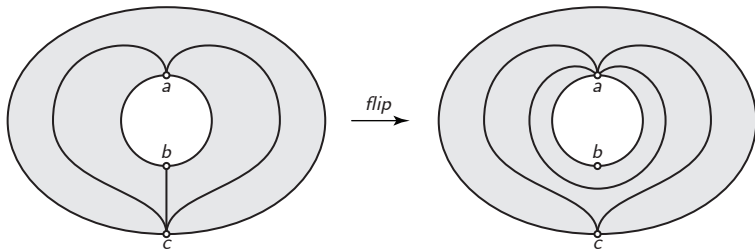

0. Preliminary definitions

The problem

Any triangulation of \mathcal{A} can be transformed into any other triangulation of \mathcal{A} by performing a sequence of flips. The *distance* of two triangulations is the minimal number of flips needed to transform one into the other.

What is the maximal distance between any two triangulations of \mathcal{A} ?

In fact, \mathcal{A} may have an infinite number of triangulations...

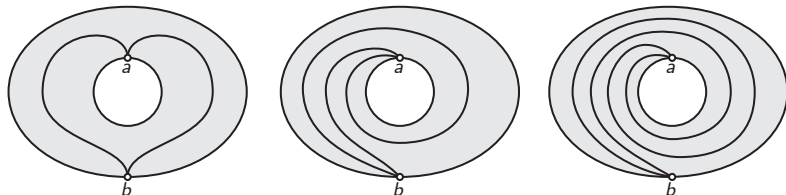

It is natural to consider the triangulations of \mathcal{A} up to homeomorphism!

0. Preliminary definitions

The problem

Let G be the graph whose:

- i. vertices are the different triangulations of \mathcal{A} up to homeomorphism,
- ii. edges connect two triangulations of \mathcal{A} if they can be obtained from one another by a flip.

As mentioned above, graph G is connected.

What is the diameter of G ?

One needs:

- An upper bound on the distance of two triangulations of \mathcal{A} ,
- Two triangulations U and V of \mathcal{A} (whose flip distance is maximal),
- A proof that U and V indeed have the desired flip distance!

1. The case of the disc

The diameters of associahedra

If \mathcal{A} is a set of n vertices in the boundary of a disc, the triangulations of \mathcal{A} can be drawn as triangulations of a convex n -gon.

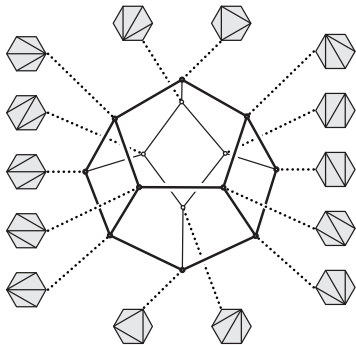
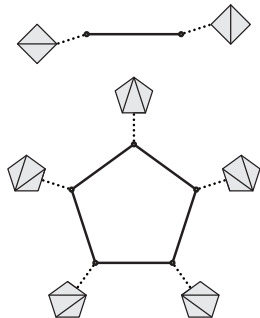
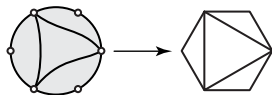

1. The case of the disc

The diameters of associahedra

The Tamari Lattice (Tamari, 1951)

A lattice whose vertices are the bracketings on $n - 1$ letters, and whose arcs correspond to the associativity rule.

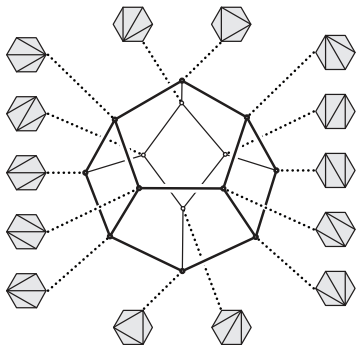
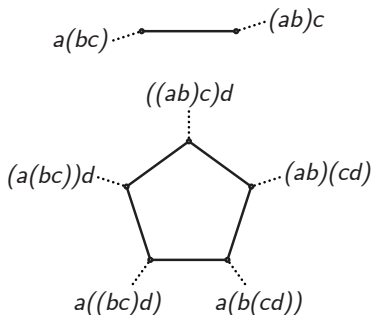

1. The case of the disc

The diameters of associahedra

Theorem (Lee, 1989)

If the surface is a disc, and \mathcal{A} is a set of n vertices in the boundary of this disc, then G is the graph of the $(n - 3)$ -dimensional associahedron.

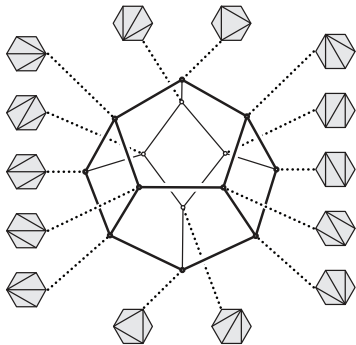
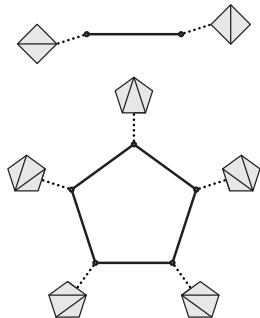

1. The case of the disc

Equivalence with the rotation distance of binary trees

While working to the dynamic optimality conjecture, Daniel Sleator, Robert Tarjan, and William Thurston note the equivalence between:

- i. The triangulations of a polygon with n vertices and their flips,
- ii. The binary trees of size $n - 2$ and their rotations.

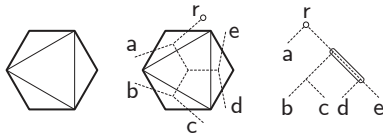

By duality:

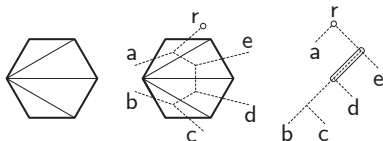

1. The case of the disc

Equivalence with the rotation distance of binary trees

Daniel Sleator, Robert Tarjan, and William Thurston prove that:

Theorem (Sleator, Tarjan, Thurston, 1988)

If Δ_n is the diameter of the flip-graph of a convex n -gon,

- i. $\Delta_n \leq 2n - 10$ when n is greater than 12,
- ii. $\Delta_n = 2n - 10$ when n is **large enough**.

Two problems remained open for about 25 years:

- Is there a combinatorial proof (of ii.)?
- Does **large enough** mean greater than 12?

Recent progress :

- Combinatorial proof that $\Delta_n = 2n - O(\sqrt{n})$ (Dehornoy, 2010),
- The answer to both questions is yes (P. 2014).

1. The case of the disc

Proof of the upper bound (Sleator et al. 1988)

In order to obtain the upper bound of $2n - 10$, flip a triangulation U (left) to a canonical triangulation (right) as follows:

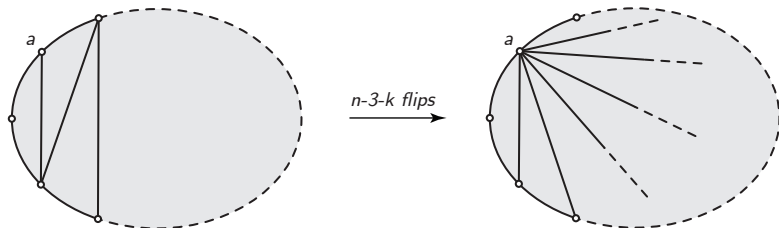

Here, k is the number of interior edges of U incident to vertex a . Call l the number of interior edges incident to a in another triangulation V . One can transform U into V with $2n - 6 - (k + l)$ flips.

When $n > 12$, a counting argument provides a vertex a so that $k + l \geq 4$.

Hence $d(U, V) \leq 2n - 10$ when $n > 12$.

1. The case of the disc

Two triangulations at distance $2n - 10$ when $n > 12$

Consider a polygon with n vertices labeled from 0 to $n - 1$ clockwise.

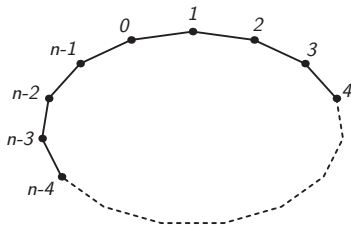

We search for two triangulations A_n^- and A_n^+ of this polygon so that:

A_n^- and A_n^+ have flip distance $2n - 10$ when $n > 12$,

There are two main difficulties:

- Finding triangulations A_n^- and A_n^+ ,
- Proving that their flip distance is indeed $2n - 10$ when $n > 12$.

1. The case of the disc

Two triangulations at distance $2n - 10$ when $n > 12$

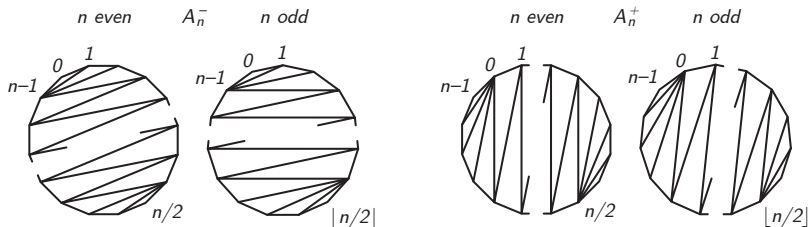

- At vertex $n - 1$: a comb with 3 teeth,
- At vertex $\lfloor n/2 \rfloor - 1$: a comb with 3 teeth if n is even and 4 teeth if n is odd.

- A comb with 4 teeth at vertex 0 ,
- At vertex $\lfloor n/2 \rfloor$: a comb with 4 teeth if n is even and 3 teeth if n is odd.

In each triangulation, the two combs are connected by a zigzag.

Call $A_n = \{A_n^-, A_n^+\}$ (can be defined whenever $n \geq 3$).

1. The case of the disc

Proof of the lower bound (main ideas)

Call $\delta(A_n) = d(A_n^-, A_n^+)$. It will be shown that when $n > 12$,

$$\delta(A_n) \geq \min(\delta(A_{n-1}) + 2, \delta(A_{n-2}) + 4, \delta(A_{n-5}) + 10, \delta(A_{n-6}) + 12).$$

Consider a path C of length k between two triangulations U and V :



Contracting a boundary edge ε of the polygon in every triangulation along this path results in a path of length $k - j$ between two triangulations U' and V' of a polygon with $n - 1$ vertices:

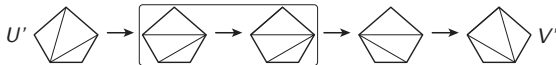

$d(U, V) \geq d(U', V') + j$, where j is the number of flips incident to ε .

1. The case of the disc

Proof of the lower bound (main ideas)

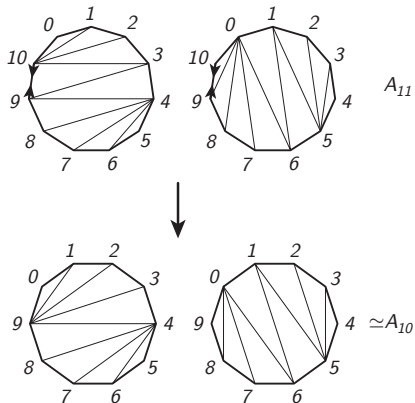
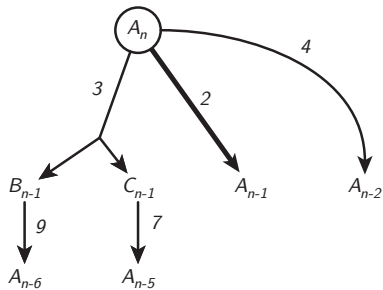

If there exists a geodesic path from A_n^- to A_n^+ with at least two flips incident to edge $\{n-2, n-1\}$, then:

$$\delta(A_n) \geq \delta(A_{n-1}) + 2.$$

1. The case of the disc

Proof of the lower bound (main ideas)

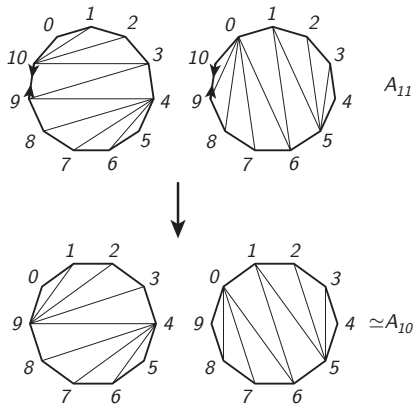
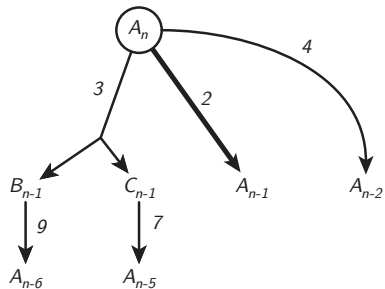

When $n > 12$,

$$\delta(A_n) \geq \min(\delta(A_{n-1}) + 2, \delta(A_{n-2}) + 4, \delta(A_{n-5}) + 10, \delta(A_{n-6}) + 12).$$

2. Surfaces with 2 or 3 boundaries

An upper bound for the cylinder

Consider a cylinder with n vertices in the outer boundary labeled 1 to n clockwise and one vertex labeled 0 in the inner boundary.

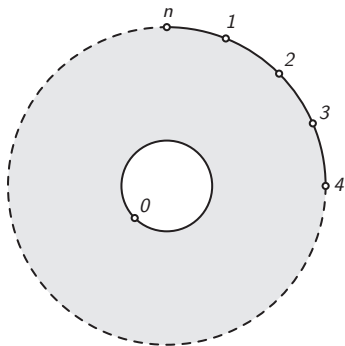

Call \mathcal{A} the set of these $n + 1$ vertices.

2. Surfaces with 2 or 3 boundaries

An upper bound for the cylinder

Using the same trick as in the case of the polygon, a triangulation U of \mathcal{A} can be transformed into a triangulation U' whose interior edges all contain 0. This triangulation contains a unique triangle with vertex set $\{0, x\}$.

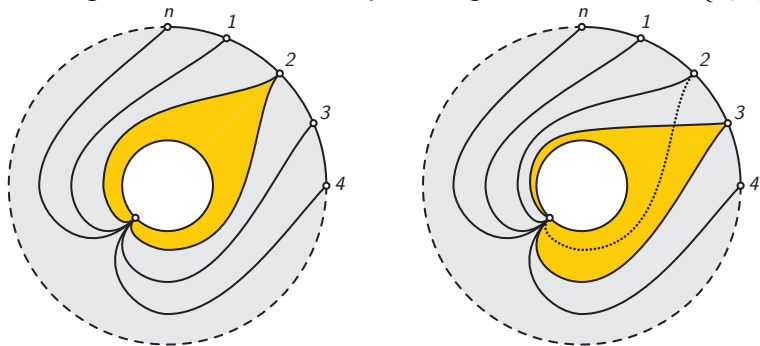

To do so, at most $n - 1$ flips are required.

2. Surfaces with 2 or 3 boundaries

An upper bound for the cylinder

Doing the same from another triangulation V will also result, after at most $n - 1$ flips in a triangulation V' whose interior edges all contain 0. This triangulation contains a unique triangle with vertex set $\{0, y\}$.

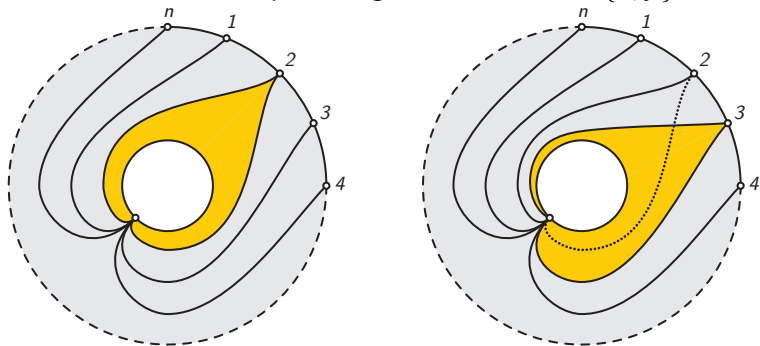

x and y are separated by at most $n/2 - 1$ vertices along the outer boundary. Bringing them together thus requires at most $n/2$ flips.

2. Surfaces with 2 or 3 boundaries

A lower bound for the cylinder

Lemma

The distance of two triangulations of \mathcal{A} is not greater than $\lfloor 5n/2 \rfloor - 2$.

It turns out that this upper bound is sharp for all $n \geq 1$.

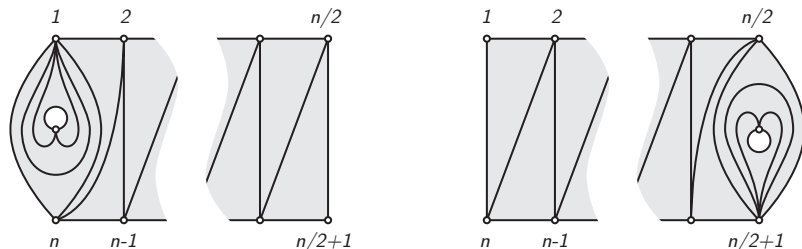

This pair of triangulations (depicted here when n is even), has flip distance $\lfloor 5n/2 \rfloor - 2$. The proof uses the same techniques as in the case of the disc.

2. Surfaces with 2 or 3 boundaries

A lower bound for the cylinder

Lemma

The distance of two triangulations of \mathcal{A} is not greater than $\lfloor 5n/2 \rfloor - 2$.

It turns out that this upper bound is sharp for all $n \geq 1$.

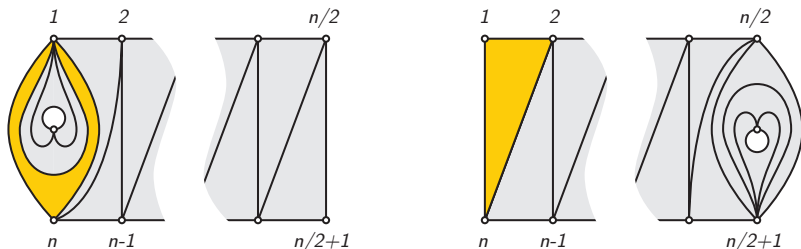

This pair of triangulations (depicted here when n is even), has flip distance $\lfloor 5n/2 \rfloor - 2$. The proof uses the same techniques as in the case of the disc.

2. Surfaces with 2 or 3 boundaries

A lower bound for the cylinder

Lemma

The distance of two triangulations of \mathcal{A} is not greater than $\lfloor 5n/2 \rfloor - 2$.

It turns out that this upper bound is sharp for all $n \geq 1$.

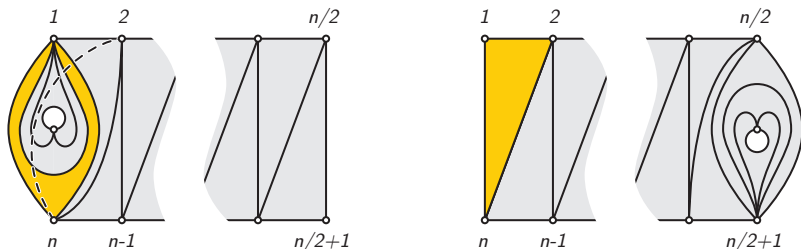

This pair of triangulations (depicted here when n is even), has flip distance $\lfloor 5n/2 \rfloor - 2$. The proof uses the same techniques as in the case of the disc.

2. Surfaces with 2 or 3 boundaries

A lower bound for a surface with 3 boundaries

Consider a surface with three boundaries. Label n vertices by 1 to n clockwise in the outer boundary. Further consider two vertices $-$ and $+$ in each of the inner boundaries.

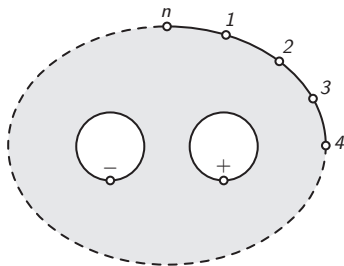

Call \mathcal{A} the set of these $n + 2$ vertices. There are pairs of triangulations of \mathcal{A} at distance $3n + O(1)$!

2. Surfaces with 2 or 3 boundaries

A lower bound for a surface with 3 boundaries

Consider a surface with three boundaries. Label n vertices by 1 to n clockwise in the outer boundary. Further consider two vertices $-$ and $+$ in each of the inner boundaries.

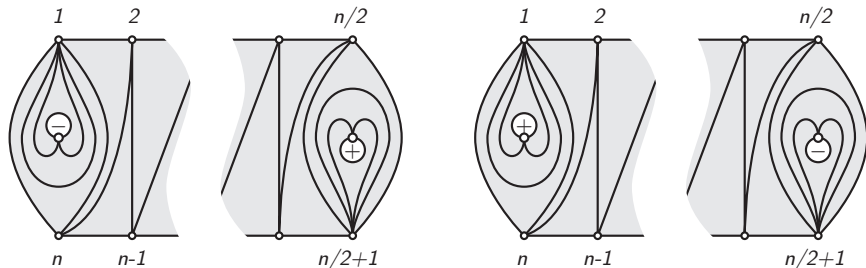

These two triangulations, also represented when n is even, have flip distance $3n + O(1)$. The proof uses the same techniques as in the case of the disc.

3. Flip distances on more general surfaces

A general upper bound

Let \mathcal{A} be a set of points placed in a surface with $r > 0$ boundaries and genus g . Assume that:

- i. the total number of boundary points is b
- ii. the total number of interior points is i ,

According to Euler's formula, the number e of **interior** edges in any triangulation of \mathcal{A} is:

$$e = 3i + b + 3r + 6g - 6.$$

How does the diameter of G behave when n (the number of points in the outer boundary) grows large at fixed i , $b - n$, r , and g ? In this case:

$$e = n + O(1).$$

3. Flip distances on more general surfaces

A general upper bound

Each interior edge of a triangulation incident to a vertex $a \in \mathcal{A}$ in the outer boundary can be removed by a flip. Removing every such edge results in an *ear* with apex a .



The number of incidences between the interior edges of two triangulations and vertices in the outer boundary is $4e = 4n + O(1)$. If n is large enough, one can introduce the same ear into these triangulations using at most 4 flips. This ear can be cut off from both triangulations, and:

Lemma

The diameter of G is at most $4n + O(1)$.

4. Conclusions

Assuming that n grows large, while the topology (r boundaries, genus g) and the number i of interior vertices remain fixed,

If $g = i = 0$:

r	Lower bound	Upper bound
1	$2n - 10$	$2n - 10^*$
2	$5n/2 - 2$	$5n/2 - 2$
3	$3n + O(1)$	$3n + O(1)$
≥ 4	$5n/2 - 2$	$4n + O(1)$

* when n is greater than 12.

If $g \neq 0$ or $i \neq 0$ and both remain constant while n grows:

- the diameter of G is at most $4n + O(1)$,
- No good lower bound is known in general,
- The case $g = 1$ and $i = 0$ looks difficult.

Conclusions

The diameter of other flip-graphs

What are the maximal flip-distances for:

- Multi-triangulations?
- Centrally symmetric triangulations?
- m -Dyck paths?
- Regular triangulations of a d -dimensional set of n points?

Theorem (Gel'fand, Kapranov, Zelevinsky 1990)

The subgraph induced in G by the regular triangulations of a (general) set of points is the graph of a polytope called the secondary polytope.

Question

Are there secondary polytopes whose diameter is “large”?

Conclusions

The diameter of other flip-graphs

Conjecture (Hirsch, 1957)

A d -dimensional polytope with n facets has diameter at most $n - d$.

Theorem (Santos, 2010)

There exists a 20-dimensional polytope with 40 facets and diameter 21.

If Δ is the largest diameter of a d -dimensional polytope with n facets,

$$\frac{21}{20}(n - d) \leq \Delta \leq n^{\log(2d)}.$$

Question

Are there secondary polytopes whose diameter is “large”?