

# Structure of Schnyder woods in higher genus

Benjamin Lévêque

CNRS, LIRMM, Montpellier, France

# Schnyder woods (planar triangulations)

Schnyder (1989)

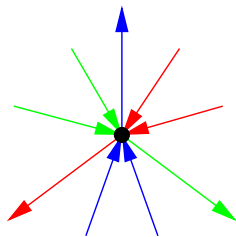

For every inner vertex

# Schnyder woods (planar triangulations)

Schnyder (1989)

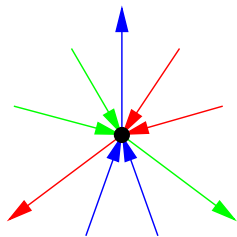

For every inner vertex

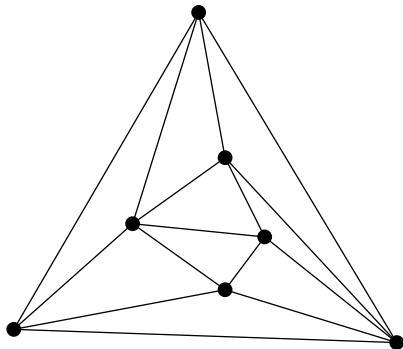

# Schnyder woods (planar triangulations)

Schnyder (1989)

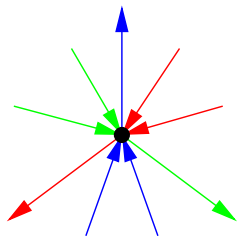

For every inner vertex

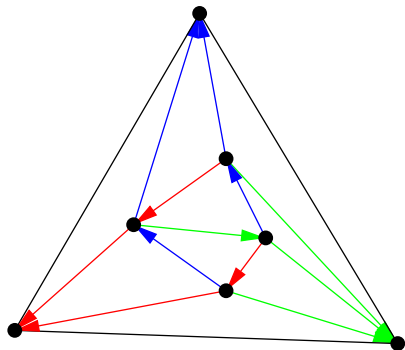

# Schnyder woods (planar triangulations)

Schnyder (1989)

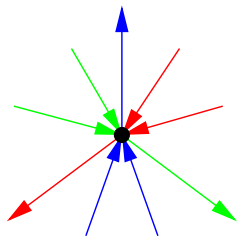

For every inner vertex

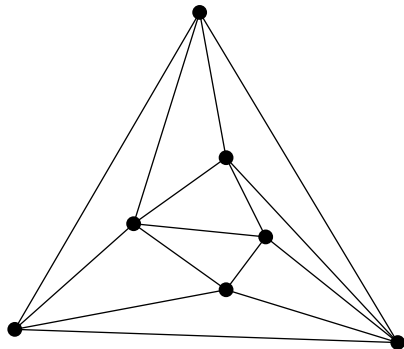

# Schnyder woods (planar triangulations)

Schnyder (1989)

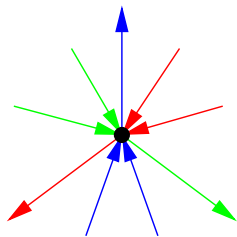

For every inner vertex

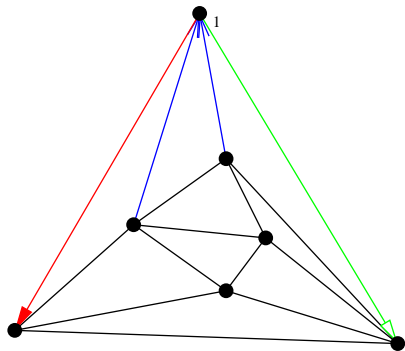

# Schnyder woods (planar triangulations)

Schnyder (1989)

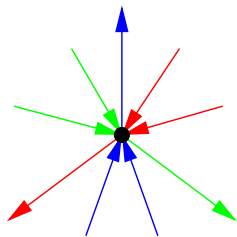

For every inner vertex

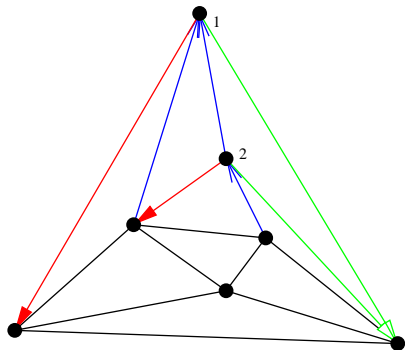

# Schnyder woods (planar triangulations)

Schnyder (1989)

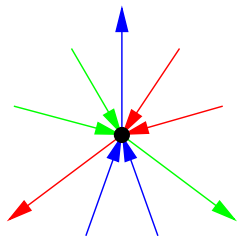

For every inner vertex

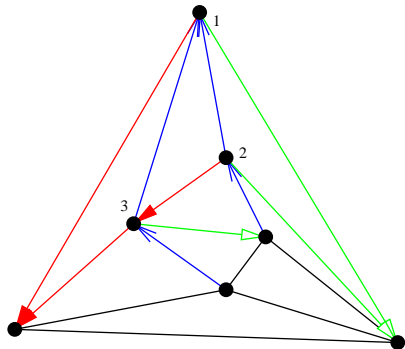



# Schnyder woods (planar triangulations)

Schnyder (1989)

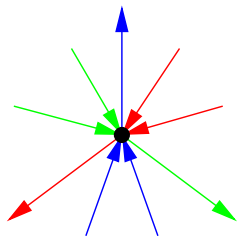

For every inner vertex

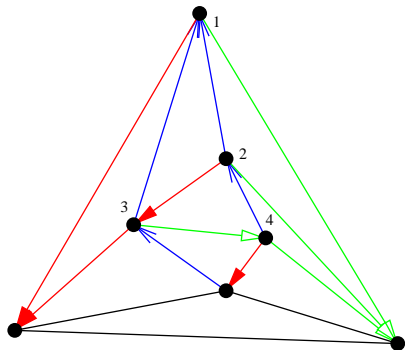

# Schnyder woods (planar triangulations)

Schnyder (1989)

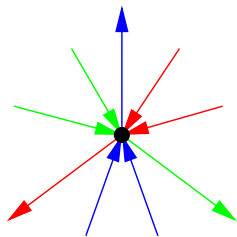

For every inner vertex

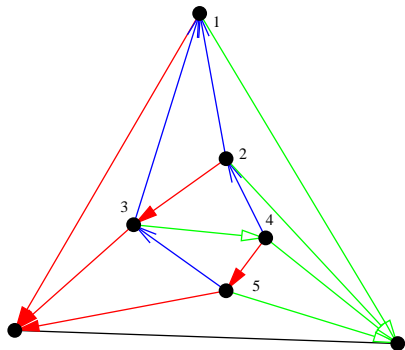

# Schnyder woods (planar triangulations)

Schnyder (1989)

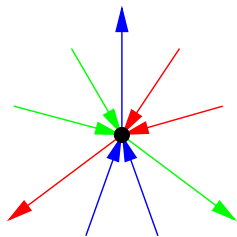

For every inner vertex

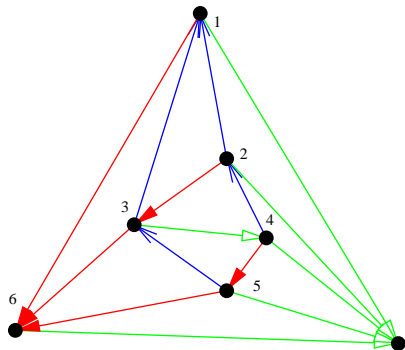

# Schnyder woods (planar triangulations)

Schnyder (1989)

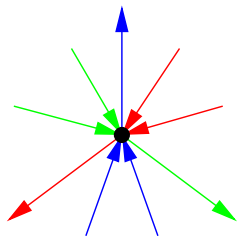

For every inner vertex

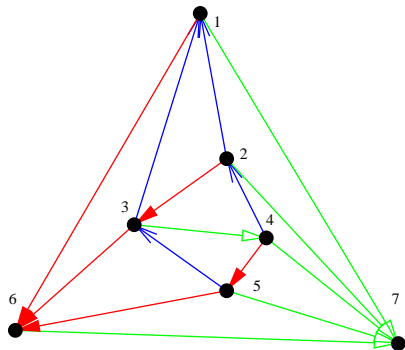

# Schnyder woods (planar triangulations)

Schnyder (1989)

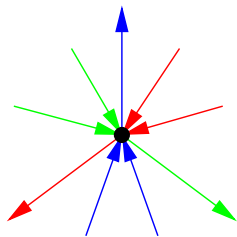

For every inner vertex

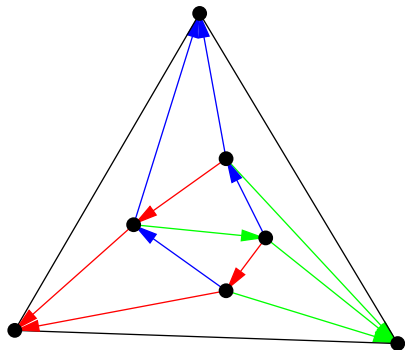

# Schnyder woods (planar triangulations)

Schnyder (1989)

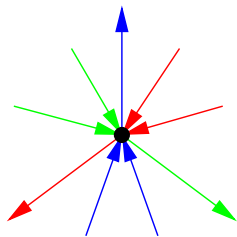

For every inner vertex

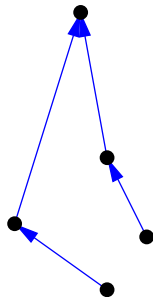

# Schnyder woods (planar triangulations)

Schnyder (1989)

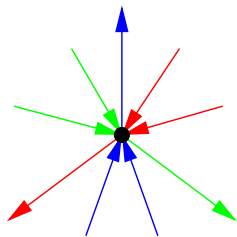

For every inner vertex

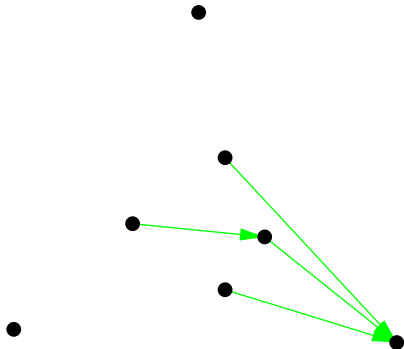

# Schnyder woods (planar triangulations)

Schnyder (1989)

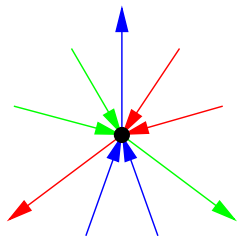

For every inner vertex

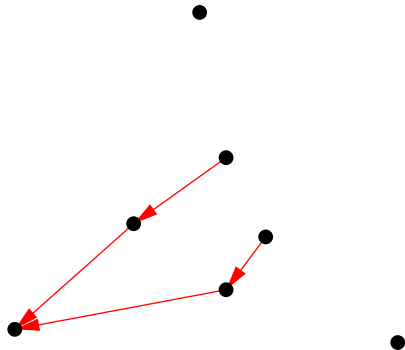



# Schnyder woods (planar triangulations)

Schnyder (1989)

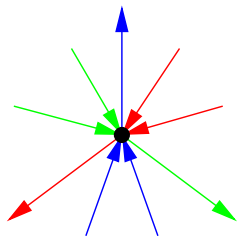

For every inner vertex

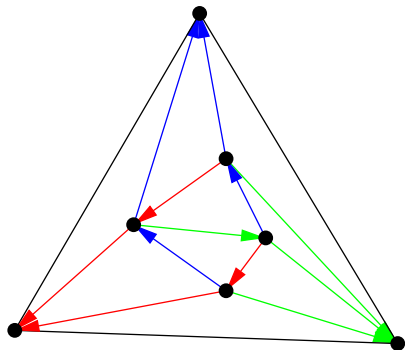

# Schnyder woods (planar triangulations)

Schnyder (1989)

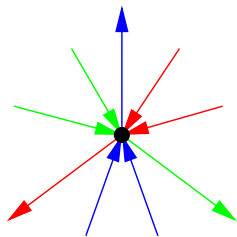

For every inner vertex

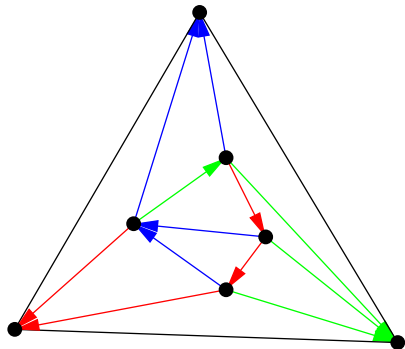

# Schnyder woods (planar triangulations)

Schnyder (1989)

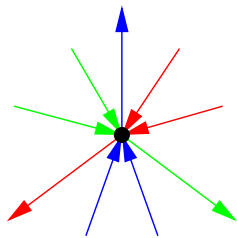

For every inner vertex

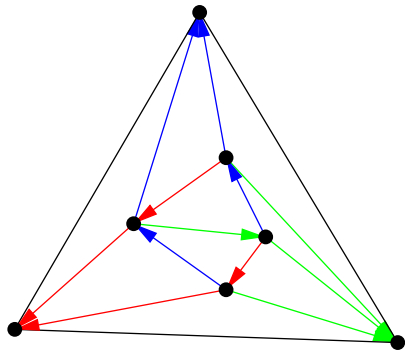

# Schnyder woods (planar triangulations)

Schnyder (1989)

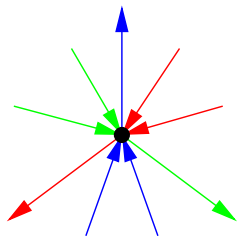

For every inner vertex

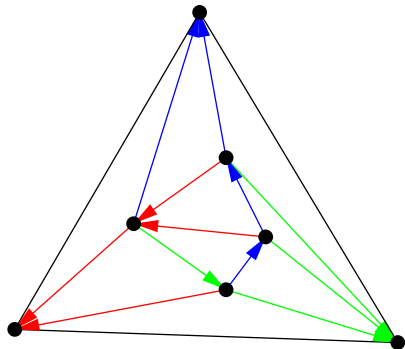

# Schnyder woods (planar triangulations)

Schnyder (1989)

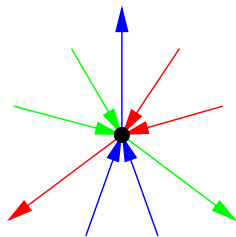

For every inner vertex

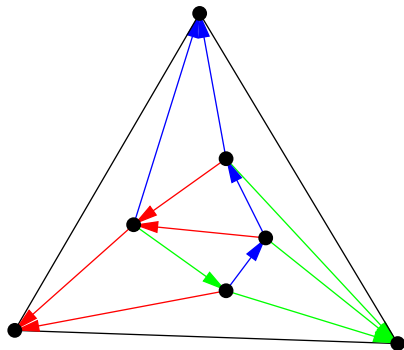

Planar graph  $\iff$  Incident poset has DM-dimension  $\leq 3$

# Optimal encoding

Poulalhon and Schaeffer (2003)

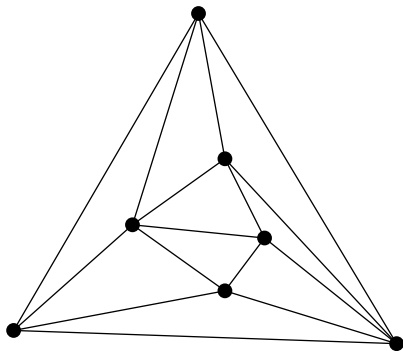

# Optimal encoding

Poulalhon and Schaeffer (2003)

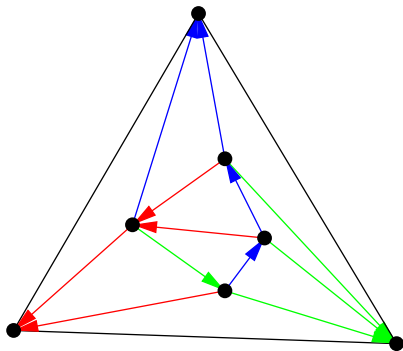

# Optimal encoding

Poulalhon and Schaeffer (2003)

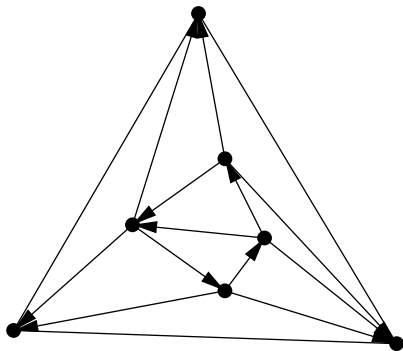



# Optimal encoding

Poulalhon and Schaeffer (2003)

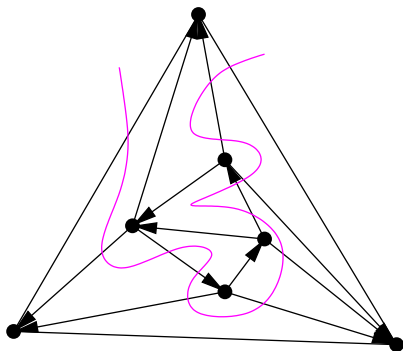

# Optimal encoding

Poulalhon and Schaeffer (2003)

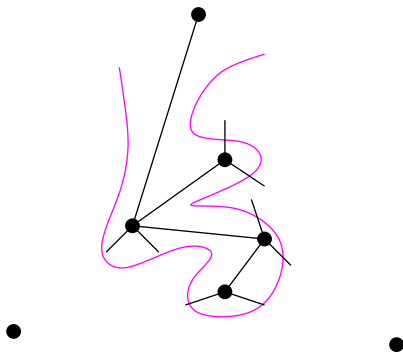

# Optimal encoding

Poulalhon and Schaeffer (2003)

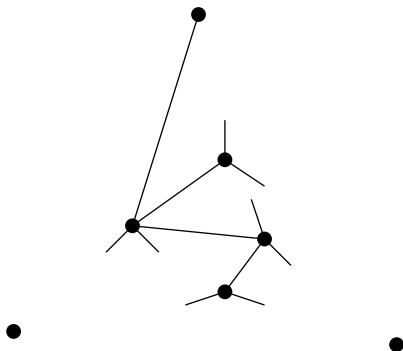

# Optimal encoding

Poulalhon and Schaeffer (2003)

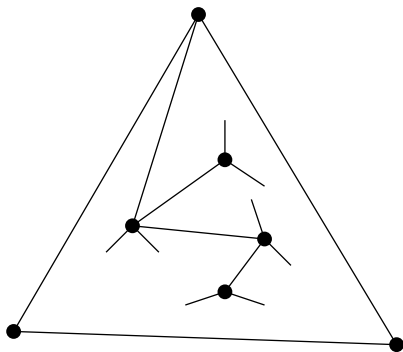

# Optimal encoding

Poulalhon and Schaeffer (2003)

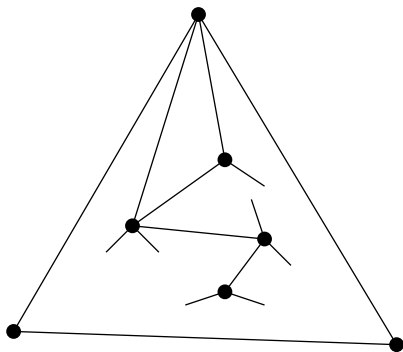

# Optimal encoding

Poulalhon and Schaeffer (2003)

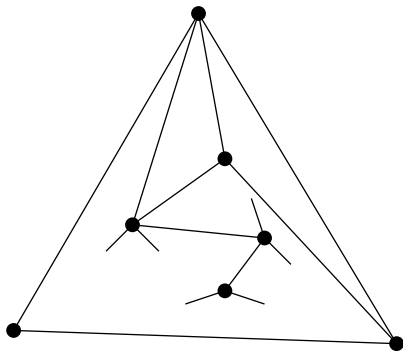

# Optimal encoding

Poulalhon and Schaeffer (2003)

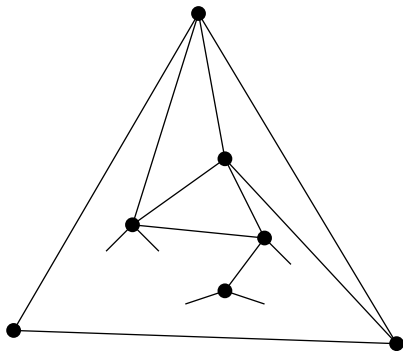

# Optimal encoding

Poulalhon and Schaeffer (2003)

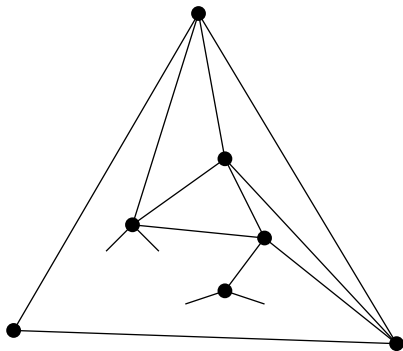



# Optimal encoding

Poulalhon and Schaeffer (2003)

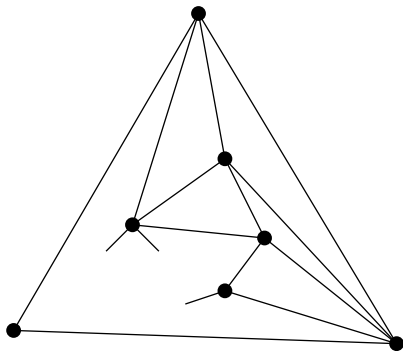

# Optimal encoding

Poulalhon and Schaeffer (2003)

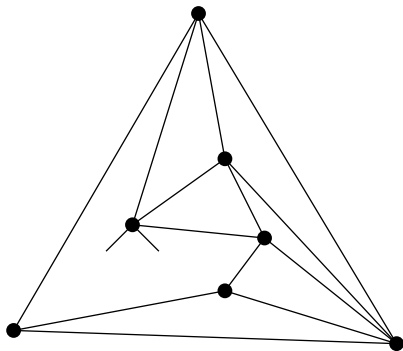

# Optimal encoding

Poulalhon and Schaeffer (2003)

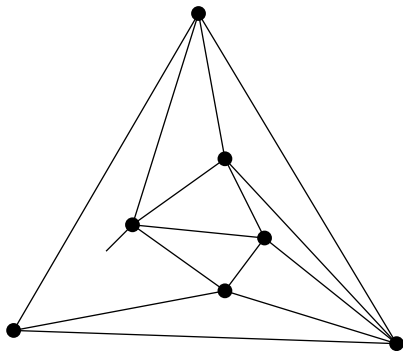

# Optimal encoding

Poulalhon and Schaeffer (2003)

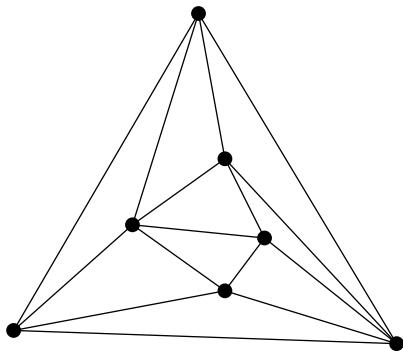

# Optimal encoding

Poulalhon and Schaeffer (2003)

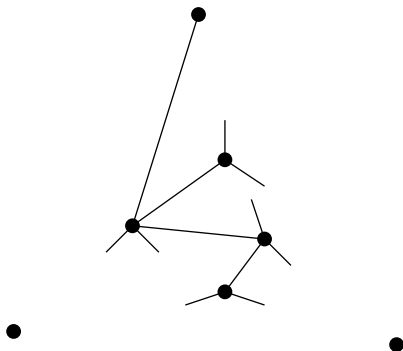



# Optimal encoding

Poulalhon and Schaeffer (2003)

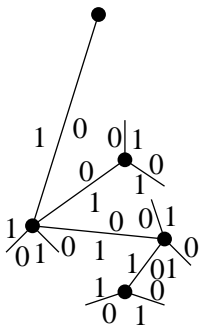

110101110100101001101000

# Optimal encoding

Poulalhon and Schaeffer (2003)

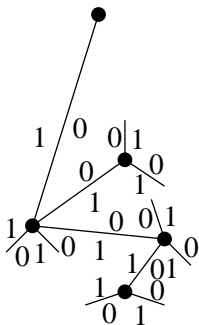

110101110100101001101000  $\rightsquigarrow$  6n bits



# Optimal encoding

Poulalhon and Schaeffer (2003)

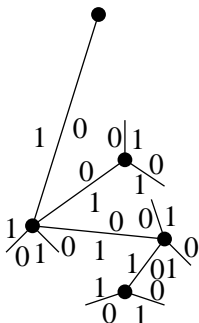

110101110100101001101000  $\rightsquigarrow$  6n bits

...1w10w10w0...

# Optimal encoding

Poulalhon and Schaeffer (2003)

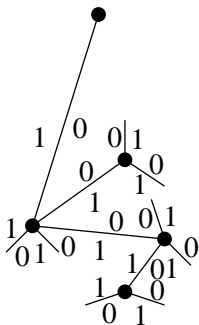

110101110100101001101000  $\rightsquigarrow$  6n bits

...1w10w10w0...

# Optimal encoding

Poulalhon and Schaeffer (2003)

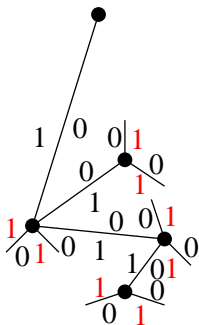

110101110100101001101000  $\rightsquigarrow$  6n bits

...1w10w10w0...

# Optimal encoding

Poulalhon and Schaeffer (2003)

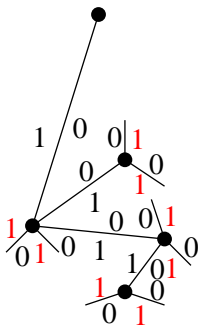

110101110100101001101000  
...1w10w10w0...

# Optimal encoding

Poulalhon and Schaeffer (2003)

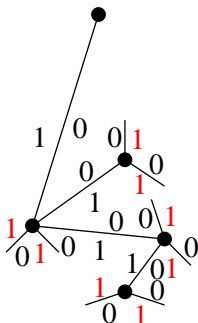

1001100000010000  
...1w10w10w0...

# Optimal encoding

Poulalhon and Schaeffer (2003)

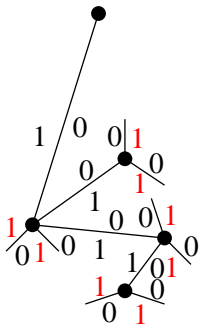

1001100000010000  $\rightsquigarrow$  4n bits

...1w10w10w0...

# Optimal encoding

Poulalhon and Schaeffer (2003)

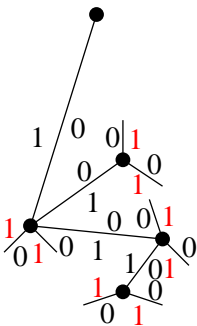

1001100000010000  $\rightsquigarrow$   $4n$  bits ( $n$  bits 1)  
...1w10w10w0...

# Optimal encoding

Poulalhon and Schaeffer (2003)

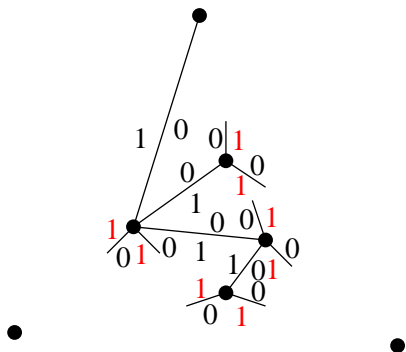

100110000010000  $\rightsquigarrow$  4n bits (n bits 1)  $\rightsquigarrow$  3,25n bits  
...1w10w10w0...



# Optimal encoding

Poulalhon and Schaeffer (2003)

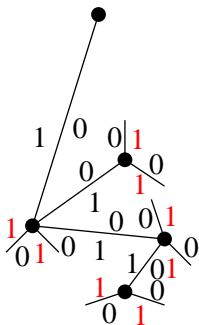

1001100000010000  $\rightsquigarrow$  4n bits (n bits 1)  $\rightsquigarrow$  3,25n bits  
...1w10w10w0... **OPTIMAL !**

# Optimal encoding

Poulalhon and Schaeffer (2003)

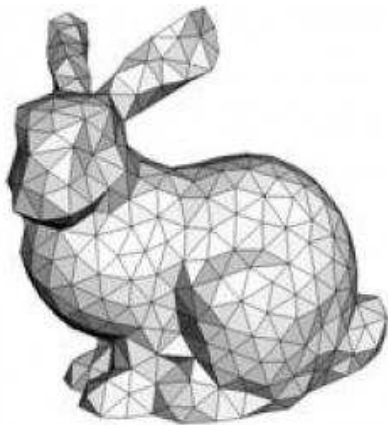

1001100000010000  $\rightsquigarrow$  4n bits (n bits 1)  $\rightsquigarrow$  3,25n bits

...1w10w10w0...

**OPTIMAL !**

# Generalization to 3-connected planar map

Felsner (2001), Miller (2002)

# Generalization to 3-connected planar map

Felsner (2001), Miller (2002)

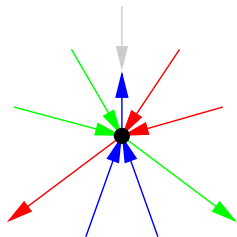

# Generalization to 3-connected planar map

Felsner (2001), Miller (2002)

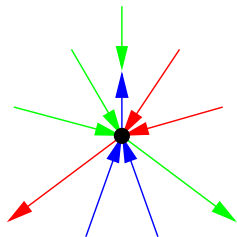

# Generalization to 3-connected planar map

Felsner (2001), Miller (2002)

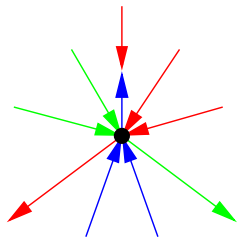

# Generalization to 3-connected planar map

Felsner (2001), Miller (2002)

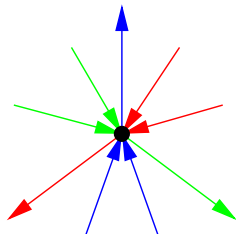

For every vertex

# Generalization to 3-connected planar map

Felsner (2001), Miller (2002)

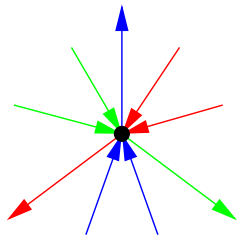

For every vertex

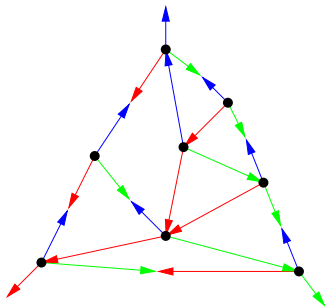



# Generalization to 3-connected planar map

Felsner (2001), Miller (2002)

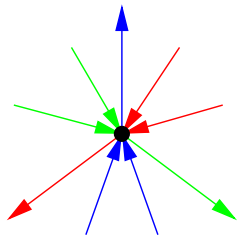

For every vertex

AND

No monochromatic cycles

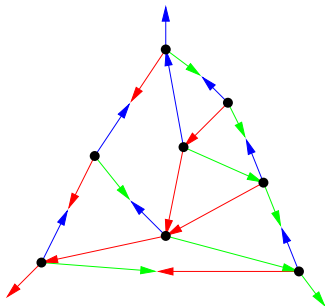

# Generalization to (internally) 3-connected planar map

Felsner (2001), Miller (2002)

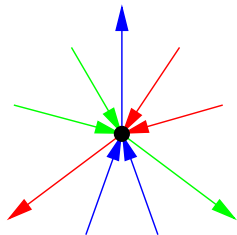

For every vertex

AND

No monochromatic cycles

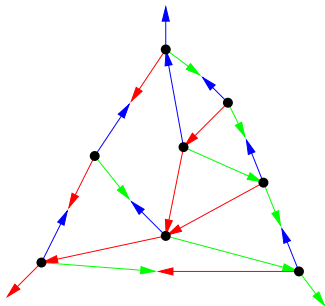

# Generalization to (internally) 3-connected planar map

Felsner (2001), Miller (2002)

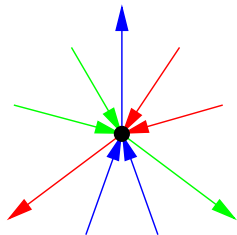

For every vertex

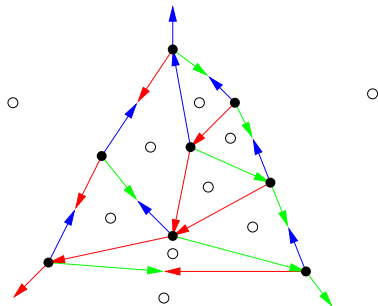

AND

No monochromatic cycles

# Generalization to (internally) 3-connected planar map

Felsner (2001), Miller (2002)

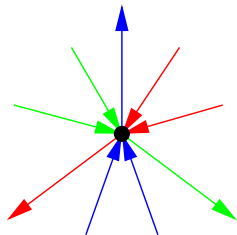

For every vertex

AND

No monochromatic cycles

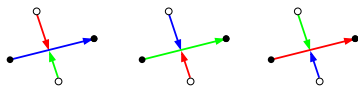
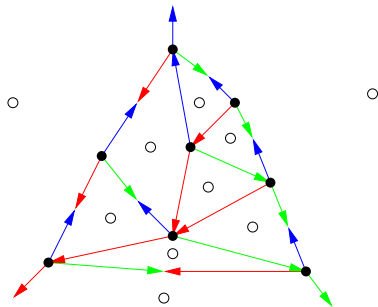

Dual rules

# Generalization to (internally) 3-connected planar map

Felsner (2001), Miller (2002)

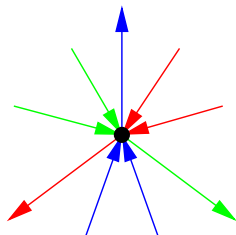

For every vertex

AND

No monochromatic cycles

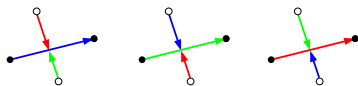
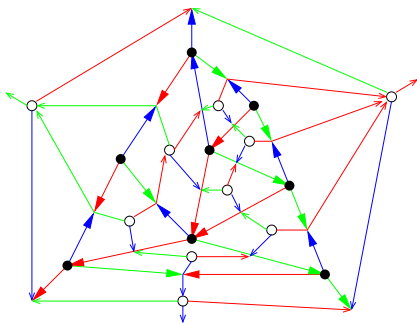

Dual rules

# Generalization to (internally) 3-connected planar map

Felsner (2001), Miller (2002)

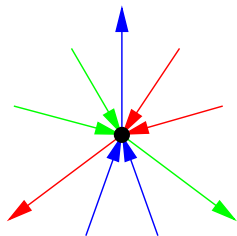

For every vertex

AND

No monochromatic cycles

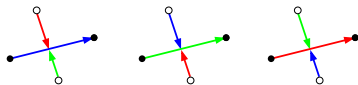
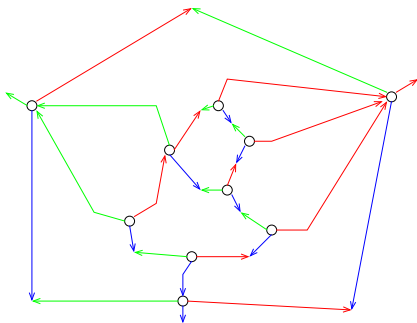

Dual rules

# Generalization to (internally) 3-connected planar map

Felsner (2001), Miller (2002)

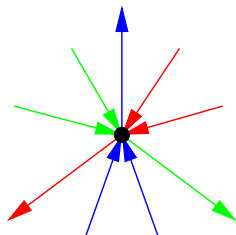

For every vertex

AND

No monochromatic cycles

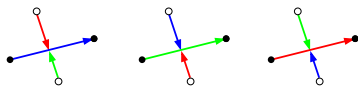
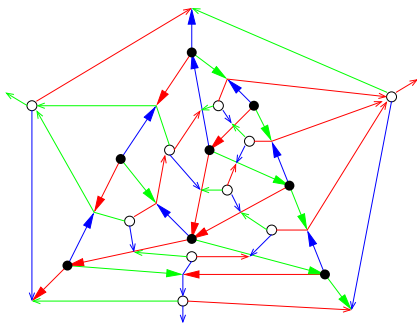

Dual rules

# Generalization to (internally) 3-connected planar map

Gonçalves, Lévêque, Pinlou (2012)

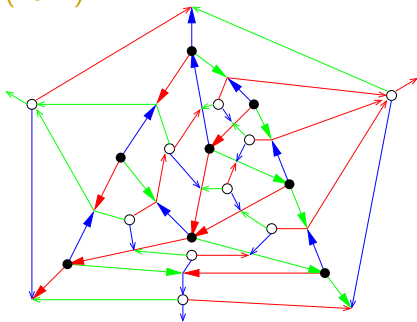
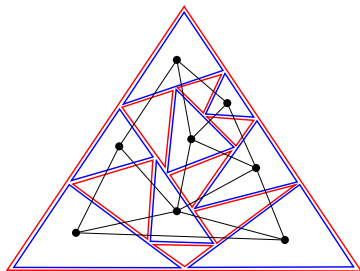



# Generalization to (internally) 3-connected planar map

Gonçalves, Lévêque, Pinlou (2012)

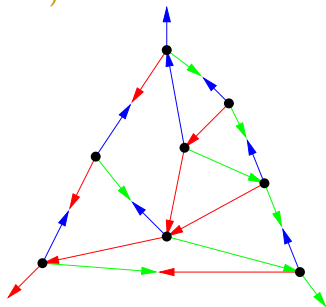
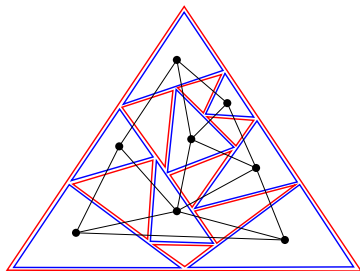

# Generalization to (internally) 3-connected planar map

Gonçalves, Lévêque, Pinlou (2012)

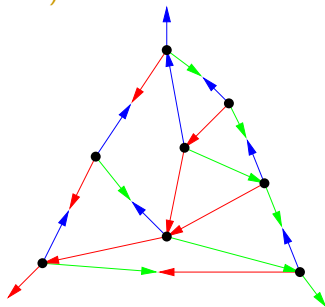
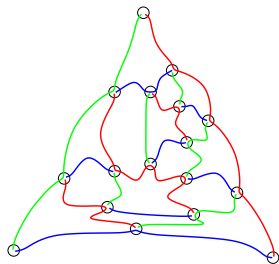

# Generalization to (internally) 3-connected planar map

Gonçalves, Lévêque, Pinlou (2012)

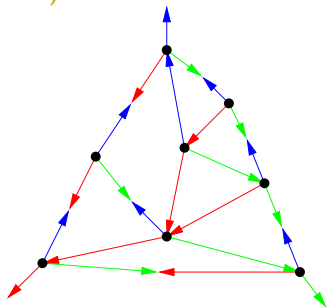
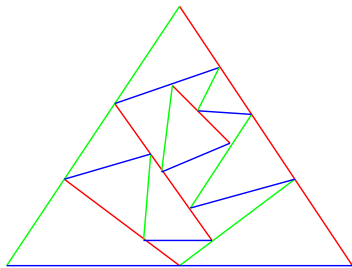

# Generalization to (internally) 3-connected planar map

Gonçalves, Lévêque, Pinlou (2012)

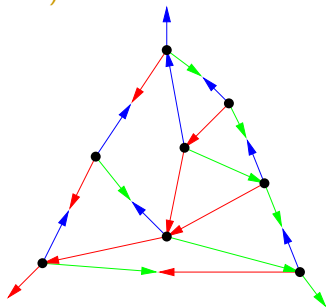
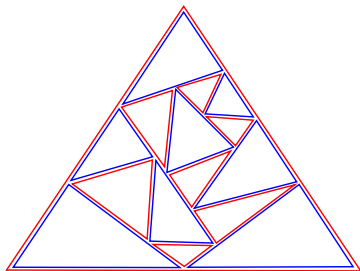

# Generalization to (internally) 3-connected planar map

Gonçalves, Lévêque, Pinlou (2012)

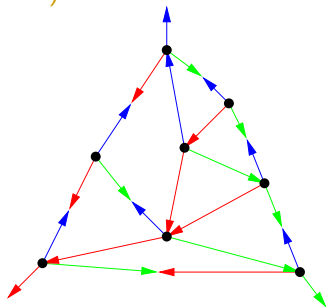
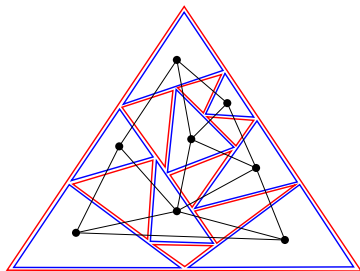

# Orthogonal surfaces

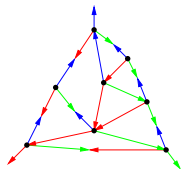
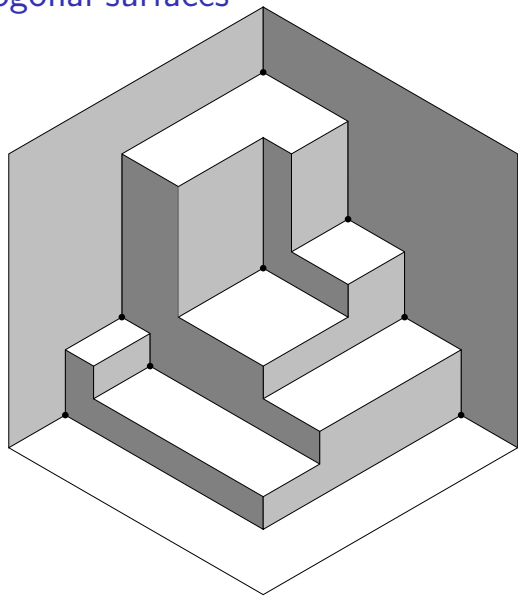

# Orthogonal surfaces

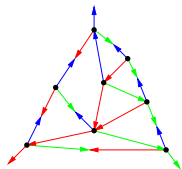
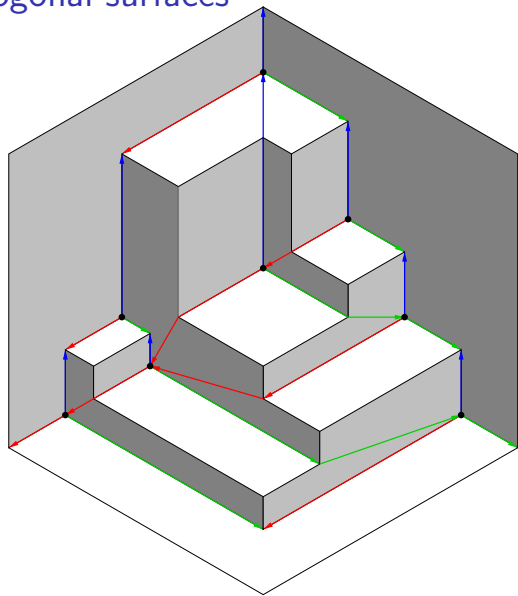

# Orthogonal surfaces

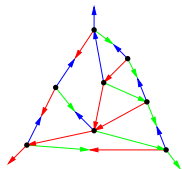
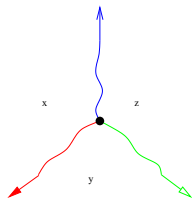
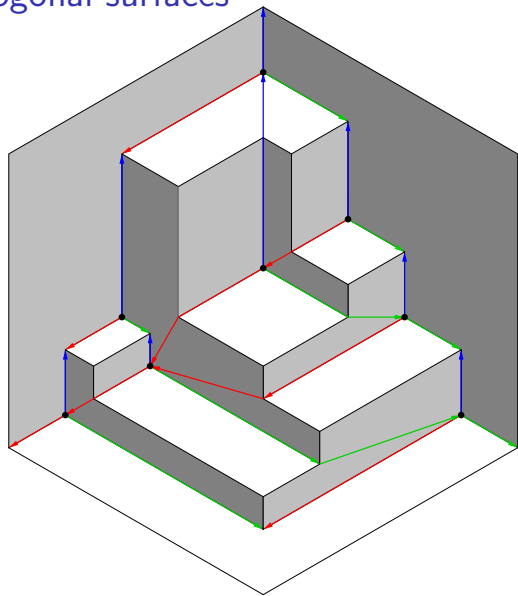



# Orthogonal surfaces

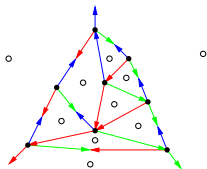
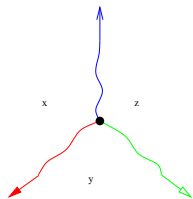
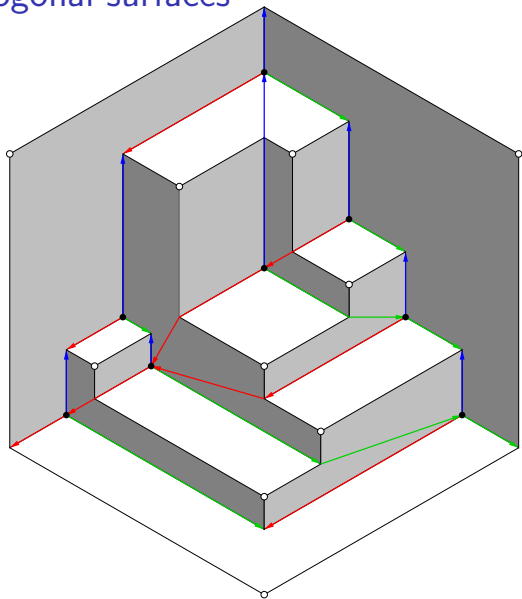

# Orthogonal surfaces

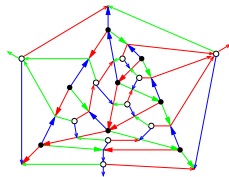
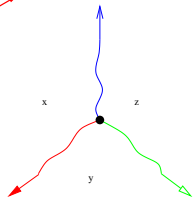
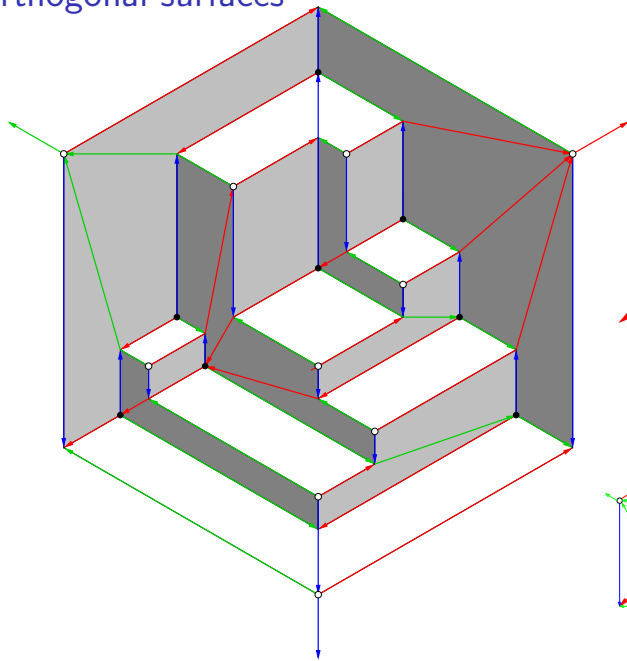

# Orthogonal surfaces

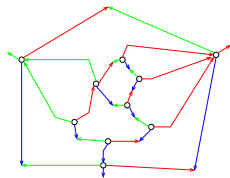
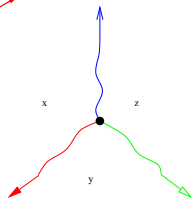
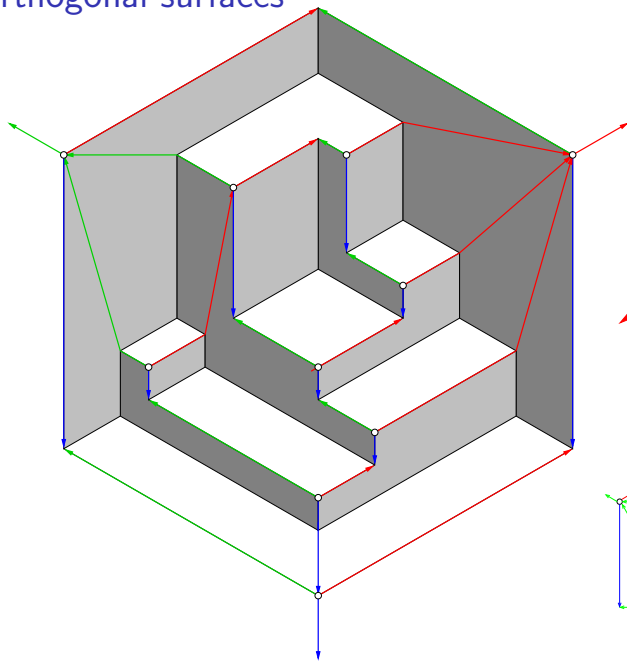

# Orthogonal surfaces

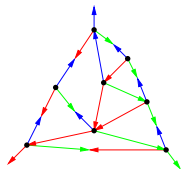
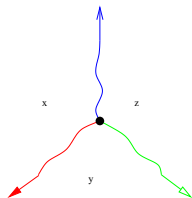
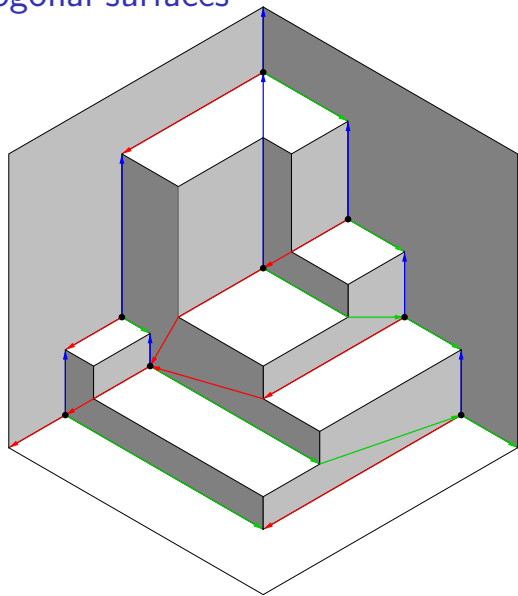

# Orthogonal surfaces

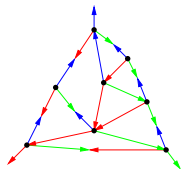
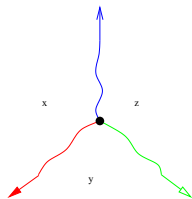
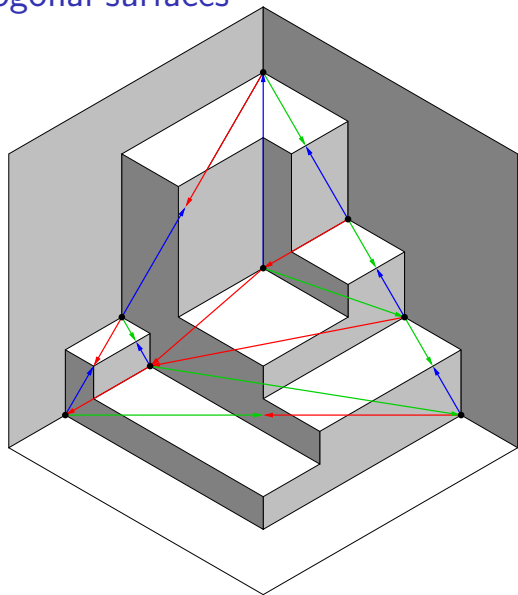

# Orthogonal surfaces

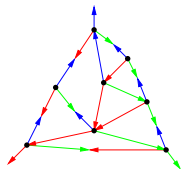
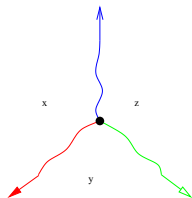
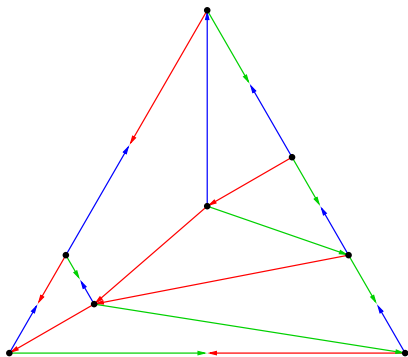

# A generalization of Schnyder woods to higher genus

# A generalization of Schnyder woods to higher genus

Castelli Aleardi, Fusy, Lewiner (2009) : applications to encoding

i) a small set  $\mathcal{E}^s$  of *special edges*, doubly oriented and colored

$(u, v, w)$

at most  $2 \cdot 2g$  multiple vertices (incident to special edges)



$\mathcal{E}^s = \{e_1, e_2\}$

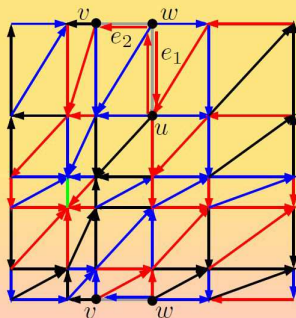

ii) a new local condition for edges in a sector incident to a multiple vertex

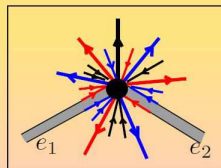



## A different approach

## A different approach

Euler's formula in genus  $g$  :  $n - m + f = 2 - 2g$

## A different approach

Euler's formula in genus  $g$  :  $n - m + f = 2 - 2g$

	Genus	Triangulation
Plane	0	$m = 3n - 6$

## A different approach

Euler's formula in genus  $g$  :  $n - m + f = 2 - 2g$

	Genus	Triangulation
Plane	0	$m = 3n - 6$

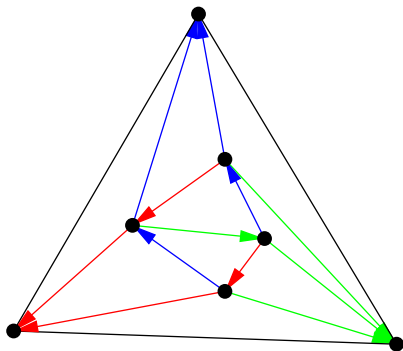

## A different approach

Euler's formula in genus  $g$  :  $n - m + f = 2 - 2g$

	Genus	Triangulation
Plane	0	$m = 3n - 6$
Torus	1	$m = 3n$

## A different approach

Euler's formula in genus  $g$  :  $n - m + f = 2 - 2g$

	Genus	Triangulation
Plane	0	$m = 3n - 6$
Torus	1	$m = 3n$

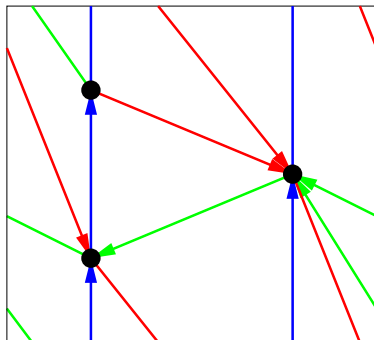

## A different approach

Euler's formula in genus  $g$  :  $n - m + f = 2 - 2g$

	Genus	Triangulation
Plane	0	$m = 3n - 6$
Torus	1	$m = 3n$
Double torus	2	$m = 3n + 6$

## A different approach

Euler's formula in genus  $g$  :  $n - m + f = 2 - 2g$

	Genus	Triangulation
Plane	0	$m = 3n - 6$
Torus	1	$m = 3n$
Double torus	2	$m = 3n + 6$
...	$g$	$m = 3n + 6(g - 1)$



## A different approach

Euler's formula in genus  $g$  :  $n - m + f = 2 - 2g$

	Genus	Triangulation
Plane	0	$m = 3n - 6$
Torus	1	$m = 3n$
Double torus	2	$m = 3n + 6$
...	$g$	$m = 3n + 6(g - 1)$

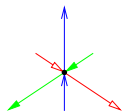

## A different approach

Euler's formula in genus  $g$  :  $n - m + f = 2 - 2g$

	Genus	Triangulation
Plane	0	$m = 3n - 6$
Torus	1	$m = 3n$
Double torus	2	$m = 3n + 6$
...	$g$	$m = 3n + 6(g - 1)$

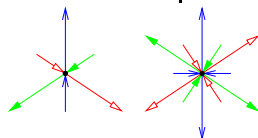

## A different approach

Euler's formula in genus  $g$  :  $n - m + f = 2 - 2g$

	Genus	Triangulation
Plane	0	$m = 3n - 6$
Torus	1	$m = 3n$
Double torus	2	$m = 3n + 6$
...	$g$	$m = 3n + 6(g - 1)$

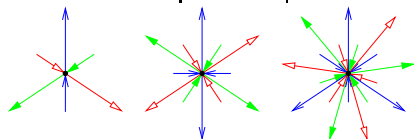

## A different approach

Euler's formula in genus  $g$  :  $n - m + f = 2 - 2g$

	Genus	Triangulation
Plane	0	$m = 3n - 6$
Torus	1	$m = 3n$
Double torus	2	$m = 3n + 6$
...	$g$	$m = 3n + 6(g - 1)$

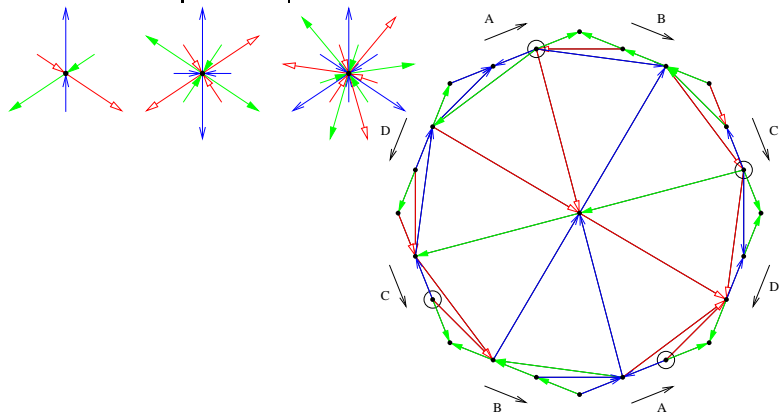

## A different approach

Euler's formula in genus  $g$  :  $n - m + f = 2 - 2g$

	Genus	Triangulation
Plane	0	$m = 3n - 6$
Torus	1	$m = 3n$
Double torus	2	$m = 3n + 6$
...	$g$	$m = 3n + 6(g - 1)$

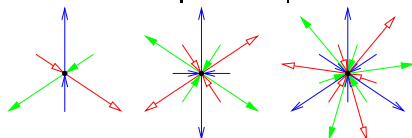

## A different approach

Euler's formula in genus  $g$  :  $n - m + f = 2 - 2g$

	Genus	Triangulation
Plane	0	$m = 3n - 6$
Torus	1	$m = 3n$
Double torus	2	$m = 3n + 6$
...	$g$	$m = 3n + 6(g - 1)$

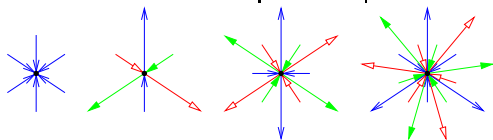

## A different approach

Euler's formula in genus  $g$  :  $n - m + f = 2 - 2g$

	Genus	Triangulation
Plane	0	$m = 3n - 6$
Torus	1	$m = 3n$
Double torus	2	$m = 3n + 6$
...	$g$	$m = 3n + 6(g - 1)$

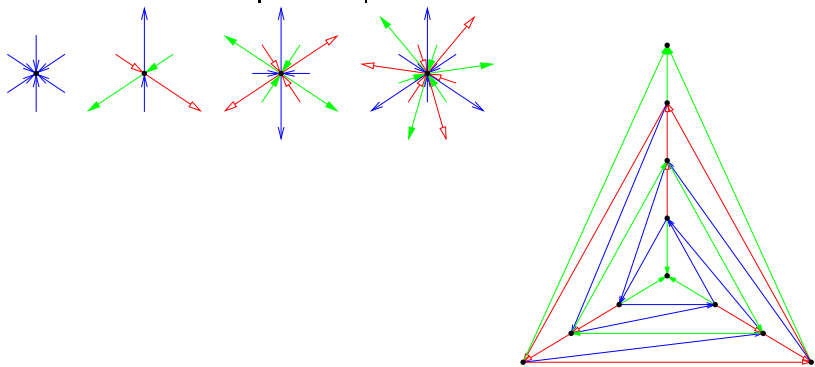

## A different approach

Euler's formula in genus  $g$  :  $n - m + f = 2 - 2g$

	Genus	Triangulation
Plane	0	$m = 3n - 6$
Torus	1	$m = 3n$
Double torus	2	$m = 3n + 6$
...	$g$	$m = 3n + 6(g - 1)$

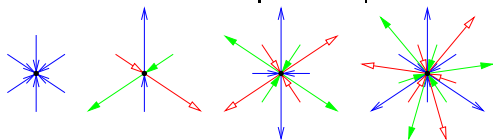



## A different approach

Euler's formula in genus  $g$  :  $n - m + f = 2 - 2g$

	Genus	Triangulation
Plane	0	$m = 3n - 6$
Torus	1	$m = 3n$
Double torus	2	$m = 3n + 6$
...	$g$	$m = 3n + 6(g - 1)$

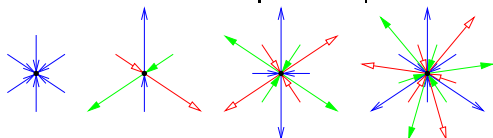

**Theorem Barát, Thomassen (2006)**

Triangulation on a surface  $\implies$

orientation of the edges such that  $d^+(v) \equiv 0 \pmod{3}$

## A different approach

Euler's formula in genus  $g$  :  $n - m + f = 2 - 2g$

	Genus	Triangulation
Plane	0	$m = 3n - 6$
Torus	1	$m = 3n$
Double torus	2	$m = 3n + 6$
...	$g$	$m = 3n + 6(g - 1)$

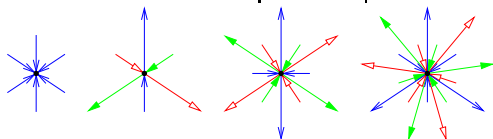

**Theorem** Albar, Gonçalves, Knauer (2014)

Triangulation on a surface  $\implies$

orientation of the edges such that  $d^+(v) \equiv 0 \pmod{3}$ ,  $d^+(v) > 0$

# Characterization

# Characterization

Plane : Schnyder wood  $\iff$  3-orientation

## Characterization

Plane : Schnyder wood  $\iff$  3-orientation

Higher genus : Schnyder wood  $\iff$   $(0 \bmod 3)$ -orientation ?

## Characterization

Plane : Schnyder wood  $\iff$  3-orientation

Higher genus : Schnyder wood  $\iff$   $(0 \bmod 3)$ -orientation ?

False !

# Characterization

Plane : Schnyder wood  $\iff$  3-orientation

Higher genus : Schnyder wood  $\iff$  (0 mod 3)-orientation ?

False !

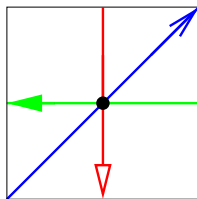
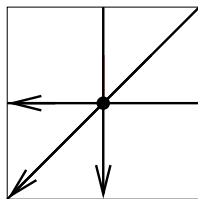

# Characterization

Plane : Schnyder wood  $\iff$  3-orientation

Higher genus : Schnyder wood  $\iff$   $(0 \pmod 3)$ -orientation ?

False !

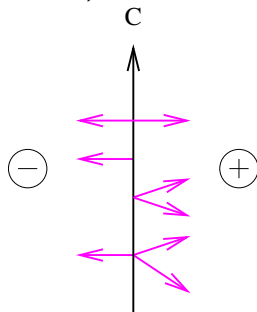
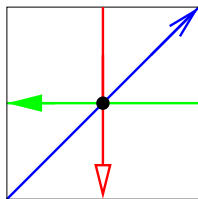
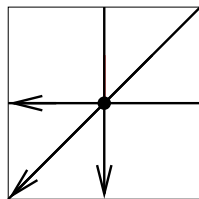



# Characterization

Plane : Schnyder wood  $\iff$  3-orientation

Higher genus : Schnyder wood  $\iff$  (0 mod 3)-orientation ?

False !

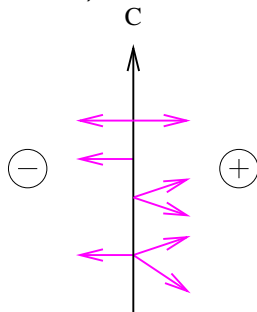
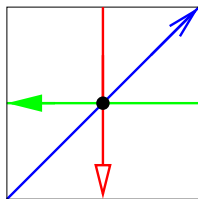
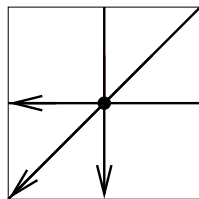

$$\gamma(C) = \#_{\rightarrow} - \#_{\leftarrow}$$

# Characterization

Plane : Schnyder wood  $\iff$  3-orientation

Higher genus : Schnyder wood  $\iff$  (0 mod 3)-orientation ?

False !

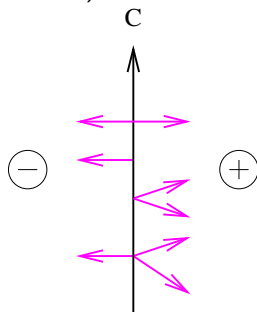
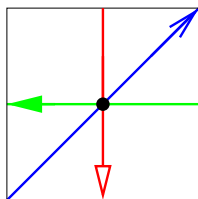
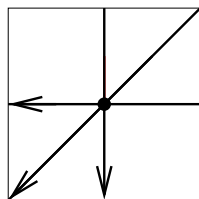

$$\gamma(C) = \#\rightarrow - \#\leftarrow$$

**Theorem** Lévêque, Gonçalves, Knauer (2014)

Schnyder wood  $\iff$  (0 mod 3)-orientation and

$\gamma(C) = 0 \pmod 3$  for any cycle

# Characterization

Plane : Schnyder wood  $\iff$  3-orientation

Higher genus : Schnyder wood  $\iff$  (0 mod 3)-orientation ?  
False !

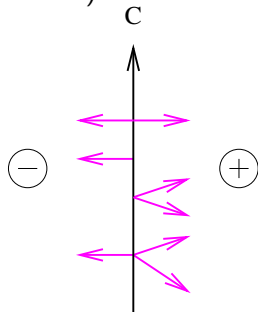
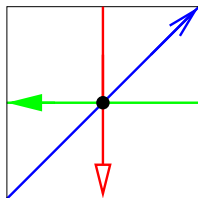
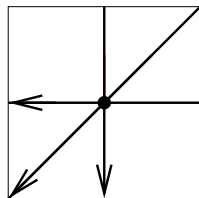

$$\gamma(C) = \#\rightarrow - \#\leftarrow$$

**Theorem** Lévêque, Gonçalves, Knauer (2014)

Schnyder wood  $\iff$  (0 mod 3)-orientation and

$\gamma(C) = 0 \pmod 3$  for any cycle

Homology  $\rightsquigarrow$  Check  $\gamma$  only for a base

# Transformations

# Transformations

$\neq$  2 Schnyder woods

# Transformations

$\neq 2$  Schnyder woods  $\rightsquigarrow$  Set of edges  $T$

## Transformations

$\neq 2$  Schnyder woods  $\rightsquigarrow$  Set of edges  $T = T_1, T_2, T_3$  homologous

## Transformations

$\neq$  2 Schnyder woods  $\rightsquigarrow$  Set of edges  $T = T_1, T_2, T_3$  homologous  
+ same out degree



## Transformations

$\neq$  2 Schnyder woods  $\rightsquigarrow$  Set of edges  $T = T_1, T_2, T_3$  homologous  
+ same out degree  $\quad \quad \quad$  +  $T$  Eulerian

## Transformations

- $\neq 2$  Schnyder woods  $\rightsquigarrow$  Set of edges  $T = T_1, T_2, T_3$  homologous
- + same out degree +  $T$  Eulerian
- + same value  $\gamma$  for a basis



## Transformations

- $\neq 2$  Schnyder woods  $\rightsquigarrow$  Set of edges  $T = T_1, T_2, T_3$  homologous
- + same out degree +  $T$  Eulerian
- + same value  $\gamma$  for a basis +  $T$  homology zero  $\rightsquigarrow$  Lattice

# Transformations

- $\neq 2$  Schnyder woods  $\rightsquigarrow$  Set of edges  $T = T_1, T_2, T_3$  homologous
- + same out degree
- + same value  $\gamma$  for a basis
- +  $T$  Eulerian
- +  $T$  homology zero  $\rightsquigarrow$  Lattice

3-orientations

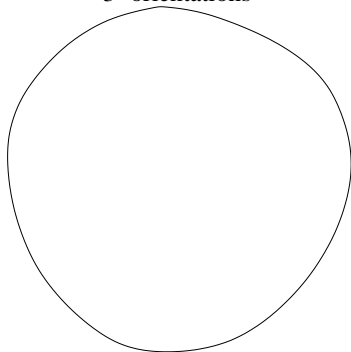

# Transformations

- $\neq 2$  Schnyder woods  $\rightsquigarrow$  Set of edges  $T = T_1, T_2, T_3$  homologous
- + same out degree
- + same value  $\gamma$  for a basis
- +  $T$  Eulerian
- +  $T$  homology zero  $\rightsquigarrow$  Lattice

3-orientations

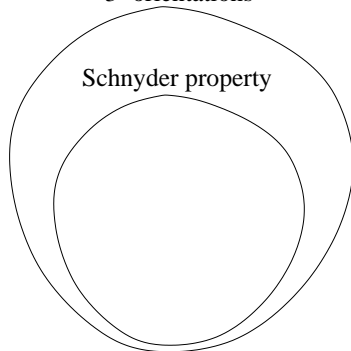

# Transformations

- $\neq 2$  Schnyder woods  $\rightsquigarrow$  Set of edges  $T = T_1, T_2, T_3$  homologous
- + same out degree
- + same value  $\gamma$  for a basis
- +  $T$  Eulerian
- +  $T$  homology zero  $\rightsquigarrow$  Lattice

3-orientations

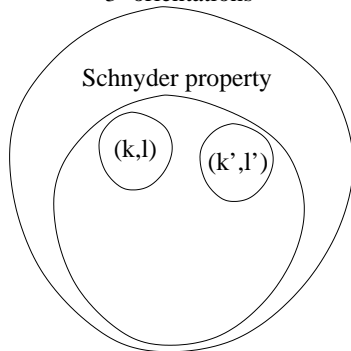

# Transformations

- $\neq 2$  Schnyder woods  $\rightsquigarrow$  Set of edges  $T = T_1, T_2, T_3$  homologous
- + same out degree
- + same value  $\gamma$  for a basis
- +  $T$  Eulerian
- +  $T$  homology zero  $\rightsquigarrow$  Lattice

3-orientations

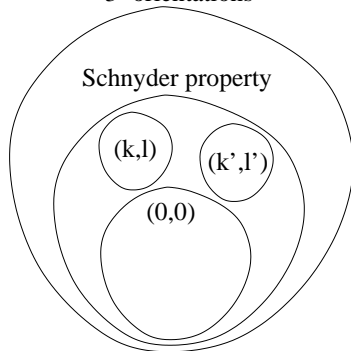



# Transformations

- $\neq 2$  Schnyder woods  $\rightsquigarrow$  Set of edges  $T = T_1, T_2, T_3$  homologous
- + same out degree
- + same value  $\gamma$  for a basis
- +  $T$  Eulerian
- +  $T$  homology zero  $\rightsquigarrow$  Lattice

3-orientations

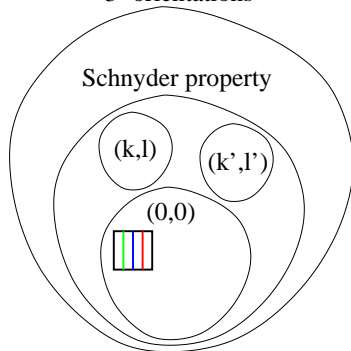

# Transformations

- $\neq 2$  Schnyder woods  $\rightsquigarrow$  Set of edges  $T = T_1, T_2, T_3$  homologous
- + same out degree
- + same value  $\gamma$  for a basis
- +  $T$  Eulerian
- +  $T$  homology zero  $\rightsquigarrow$  Lattice

3-orientations

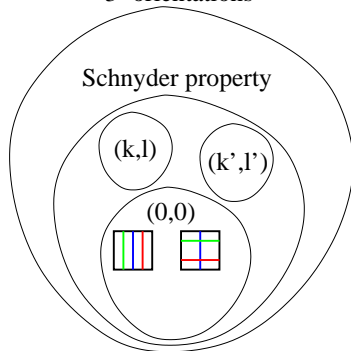

# Transformations

- $\neq 2$  Schnyder woods  $\rightsquigarrow$  Set of edges  $T = T_1, T_2, T_3$  homologous
- + same out degree
- + same value  $\gamma$  for a basis
- +  $T$  Eulerian
- +  $T$  homology zero  $\rightsquigarrow$  Lattice

3-orientations

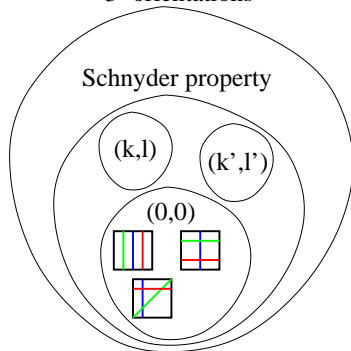

# Transformations

- $\neq 2$  Schnyder woods  $\rightsquigarrow$  Set of edges  $T = T_1, T_2, T_3$  homologous
- + same out degree
- + same value  $\gamma$  for a basis
- +  $T$  Eulerian
- +  $T$  homology zero  $\rightsquigarrow$  Lattice

3-orientations

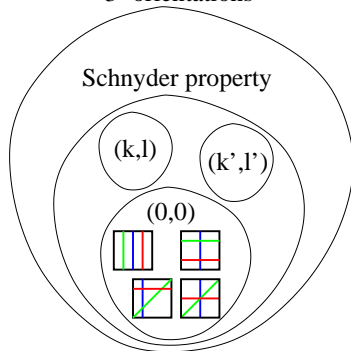

# Transformations

- $\neq 2$  Schnyder woods  $\rightsquigarrow$  Set of edges  $T = T_1, T_2, T_3$  homologous
- + same out degree
- + same value  $\gamma$  for a basis
- +  $T$  Eulerian
- +  $T$  homology zero  $\rightsquigarrow$  Lattice

3-orientations

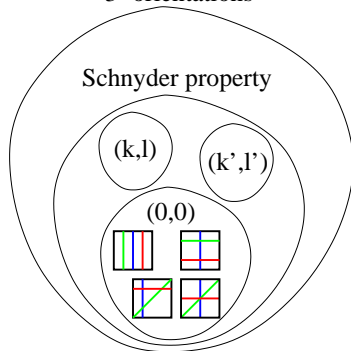

Torus : 3 proofs of existence

# Transformations

- $\neq 2$  Schnyder woods  $\rightsquigarrow$  Set of edges  $T = T_1, T_2, T_3$  homologous
- + same out degree
- + same value  $\gamma$  for a basis
- +  $T$  Eulerian
- +  $T$  homology zero  $\rightsquigarrow$  Lattice

3-orientations

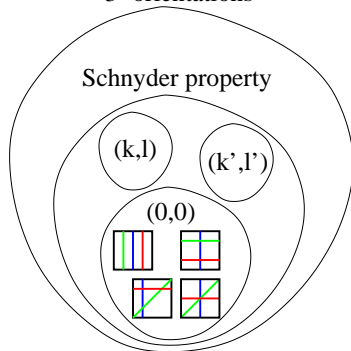

Torus : 3 proofs of existence

Nothing in higher genus !

## Transformations

- $\neq 2$  Schnyder woods  $\rightsquigarrow$  Set of edges  $T = T_1, T_2, T_3$  homologous
- + same out degree
- + same value  $\gamma$  for a basis
- +  $T$  Eulerian
- +  $T$  homology zero  $\rightsquigarrow$  Lattice

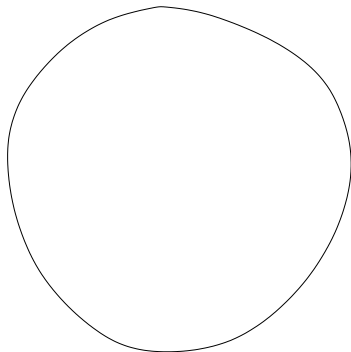

Torus : 3 proofs of existence

Nothing in higher genus !

# Transformations

- $\neq 2$  Schnyder woods  $\rightsquigarrow$  Set of edges  $T = T_1, T_2, T_3$  homologous
- + same out degree
- + same value  $\gamma$  for a basis
- +  $T$  Eulerian
- +  $T$  homology zero  $\rightsquigarrow$  Lattice



Torus : 3 proofs of existence

Nothing in higher genus !



# Transformations

- $\neq 2$  Schnyder woods  $\rightsquigarrow$  Set of edges  $T = T_1, T_2, T_3$  homologous
- + same out degree
- + same value  $\gamma$  for a basis
- +  $T$  Eulerian
- +  $T$  homology zero  $\rightsquigarrow$  Lattice



Torus : 3 proofs of existence

Nothing in higher genus !

## Torus : 1st proof of existence

## Torus : 1st proof of existence

Gluing 2 planar Schnyder woods to make a toroidal one.

## Torus : 1st proof of existence

Gluing 2 planar Schnyder woods to make a toroidal one.

### **Theorem Fijavz**

**Simple** toroidal triangulation  $\implies$  Three non contractible and non homotopic cycles that all intersect on one vertex and disjoint otherwise.

## Torus : 1st proof of existence

Gluing 2 planar Schnyder woods to make a toroidal one.

### Theorem Fijavz

Simple toroidal triangulation  $\implies$  Three non contractible and non homotopic cycles that all intersect on one vertex and disjoint otherwise.

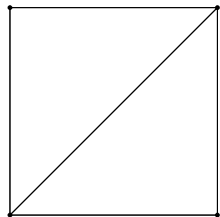

## Torus : 1st proof of existence

Gluing 2 planar Schnyder woods to make a toroidal one.

### Theorem Fijavz

Simple toroidal triangulation  $\implies$  Three non contractible and non homotopic cycles that all intersect on one vertex and disjoint otherwise.

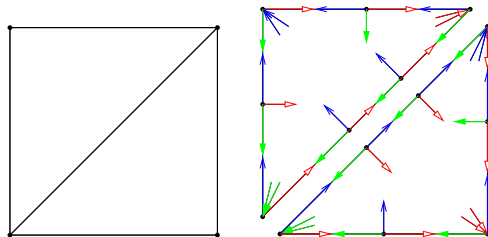

# Torus : 1st proof of existence

Gluing 2 planar Schnyder woods to make a toroidal one.

## Theorem Fijavz

Simple toroidal triangulation  $\implies$  Three non contractible and non homotopic cycles that all intersect on one vertex and disjoint otherwise.

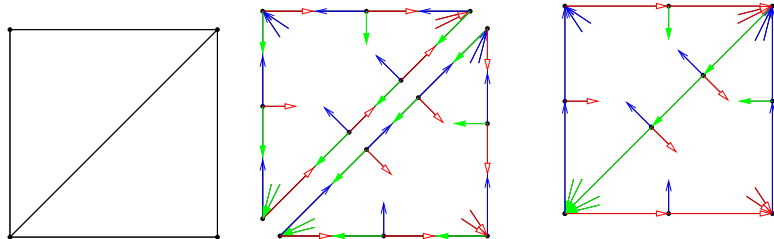

# Torus : 1st proof of existence

Gluing 2 planar Schnyder woods to make a toroidal one.

## Theorem Fijavz

Simple toroidal triangulation  $\implies$  Three non contractible and non homotopic cycles that all intersect on one vertex and disjoint otherwise.

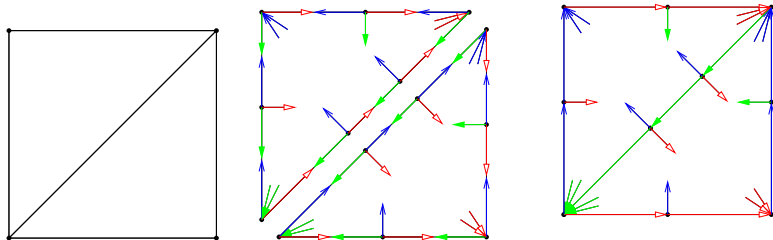

$\implies$  one-point-crossing Schnyder wood



## Torus : 2nd proof of existence

## Torus : 2nd proof of existence

By edge contraction

## Torus : 2nd proof of existence

By edge contraction

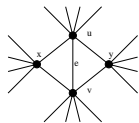

# Torus : 2nd proof of existence

By edge contraction

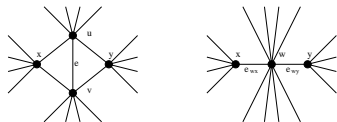

# Torus : 2nd proof of existence

By edge contraction

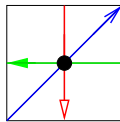
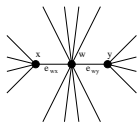
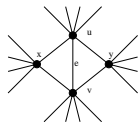

# Torus : 2nd proof of existence

By edge contraction

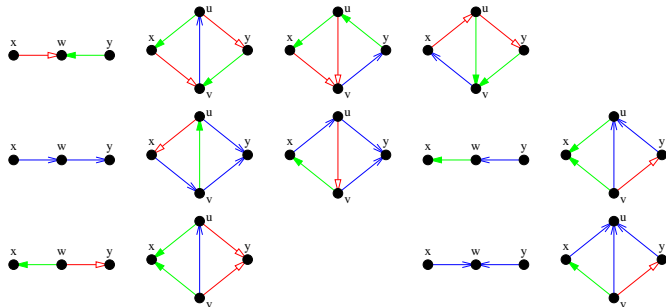
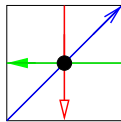
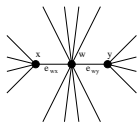
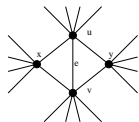

# Torus : 2nd proof of existence

By edge contraction

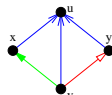
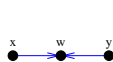
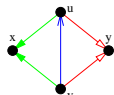
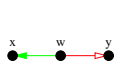
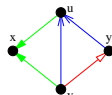
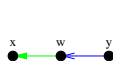
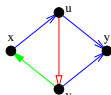
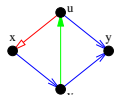
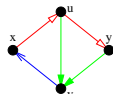
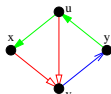
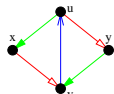
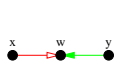
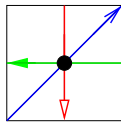
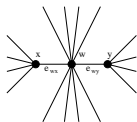
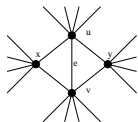

**Theorem** [Goncalves, Lévêque \(2014\)](#) A toroidal map admits a **crossing** Schnyder wood if and only if it is essentially 3-connected.

## Torus : 3rd proof of existence



# Torus : 3rd proof of existence

Start with a 3-orientation

## Torus : 3rd proof of existence

Start with a 3-orientation

**Lemme** A middle walk ends on a middle cycle.

## Torus : 3rd proof of existence

Start with a 3-orientation

**Lemme** A middle walk ends on a middle cycle.

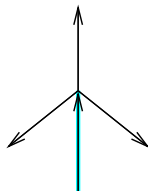

## Torus : 3rd proof of existence

Start with a 3-orientation

**Lemme** A middle walk ends on a middle cycle.

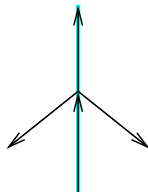

## Torus : 3rd proof of existence

Start with a 3-orientation

**Lemme** A middle walk ends on a middle cycle.

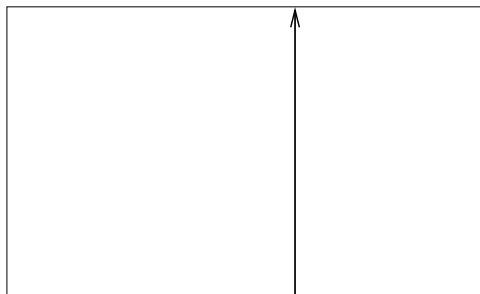
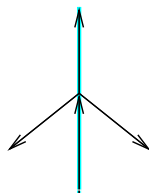

## Torus : 3rd proof of existence

Start with a 3-orientation

**Lemme** A middle walk ends on a middle cycle.

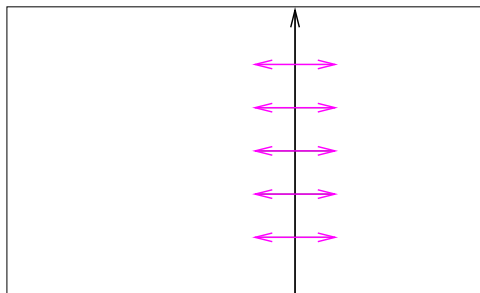
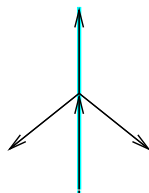

## Torus : 3rd proof of existence

Start with a 3-orientation

**Lemme** A middle walk ends on a middle cycle.

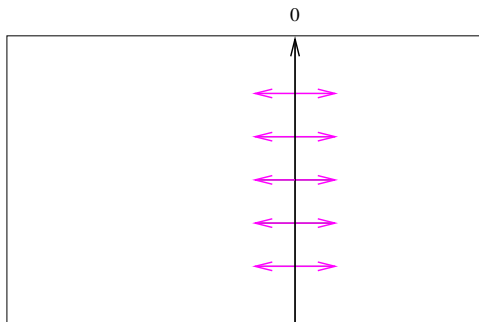
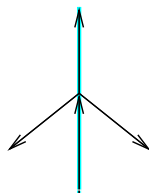

# Torus : 3rd proof of existence

Start with a 3-orientation

**Lemme** A middle walk ends on a middle cycle.

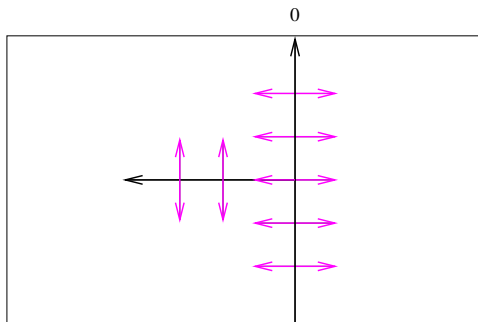
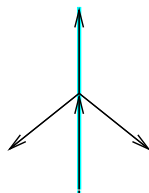



# Torus : 3rd proof of existence

Start with a 3-orientation

**Lemme** A middle walk ends on a middle cycle.

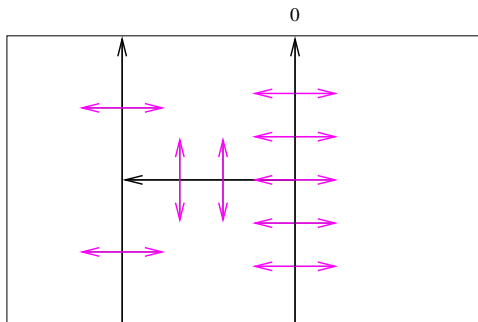
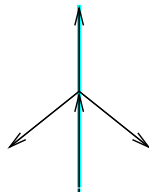

# Torus : 3rd proof of existence

Start with a 3-orientation

**Lemme** A middle walk ends on a middle cycle.

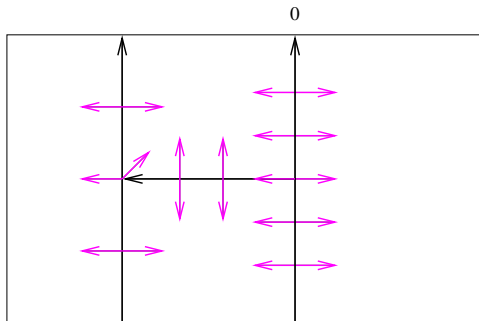
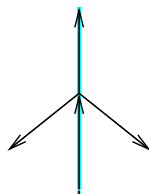

# Torus : 3rd proof of existence

Start with a 3-orientation

**Lemme** A middle walk ends on a middle cycle.

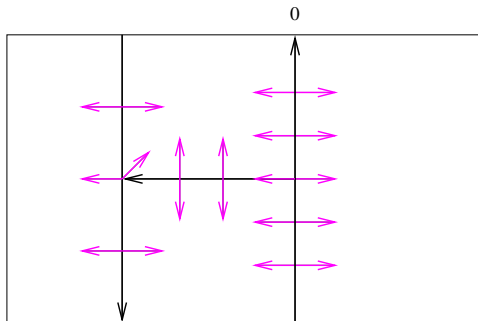
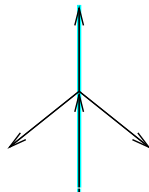

# Torus : 3rd proof of existence

Start with a 3-orientation

**Lemme** A middle walk ends on a middle cycle.

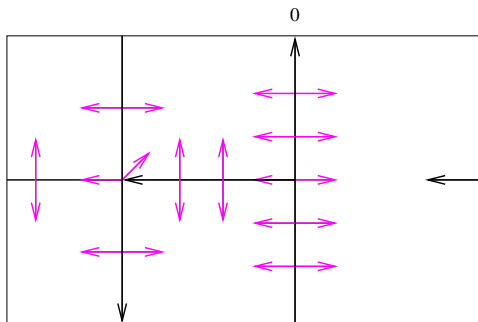
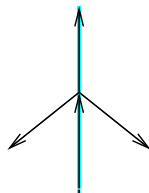

# Torus : 3rd proof of existence

Start with a 3-orientation

**Lemme** A middle walk ends on a middle cycle.

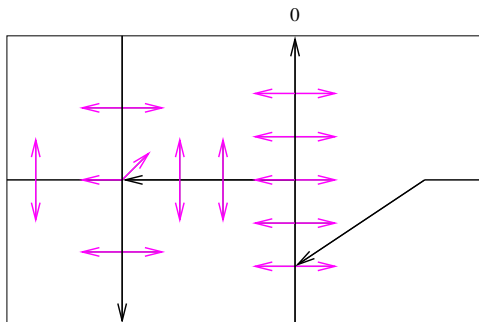
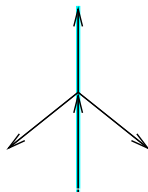

# Torus : 3rd proof of existence

Start with a 3-orientation

**Lemme** A middle walk ends on a middle cycle.

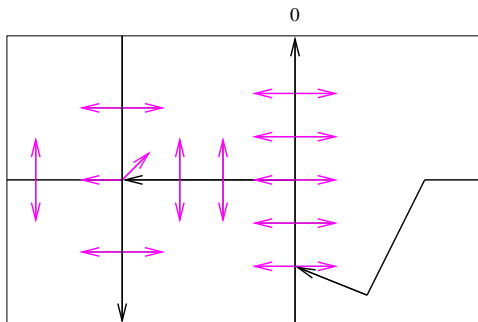
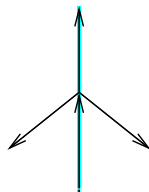

# Torus : 3rd proof of existence

Start with a 3-orientation

**Lemme** A middle walk ends on a middle cycle.

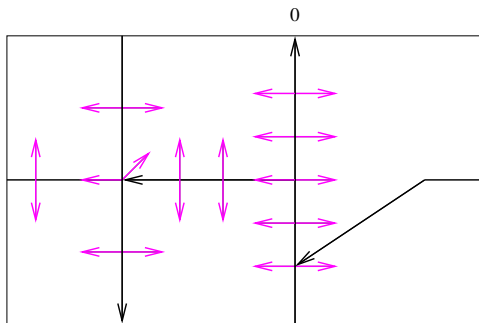
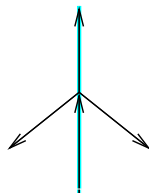

# Torus : 3rd proof of existence

Start with a 3-orientation

**Lemme** A middle walk ends on a middle cycle.

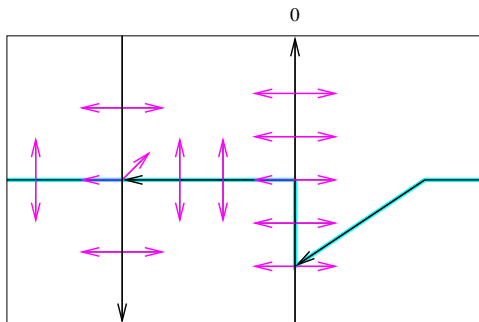
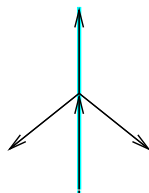



# Torus : 3rd proof of existence

Start with a 3-orientation

**Lemme** A middle walk ends on a middle cycle.

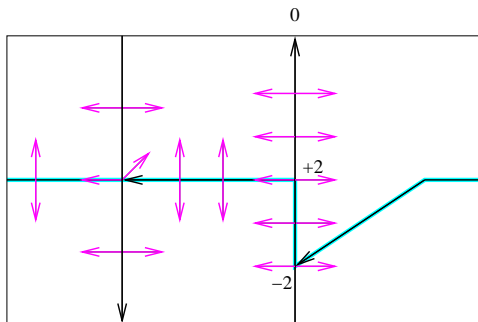
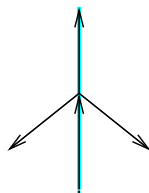

# Torus : 3rd proof of existence

Start with a 3-orientation

**Lemme** A middle walk ends on a middle cycle.

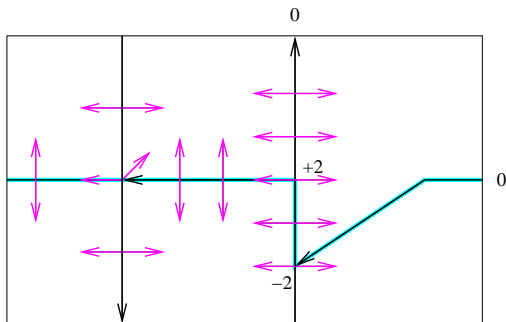
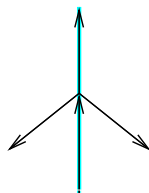

# Torus : 3rd proof of existence

Start with a 3-orientation

**Lemme** A middle walk ends on a middle cycle.

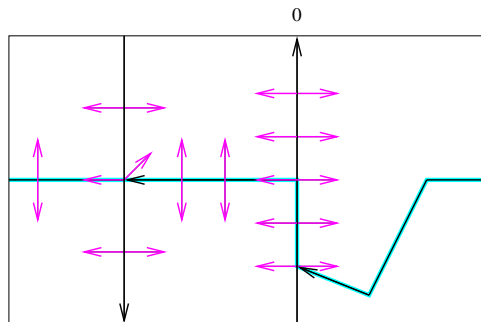
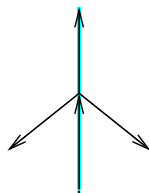

# Torus : 3rd proof of existence

Start with a 3-orientation

**Lemme** A middle walk ends on a middle cycle.

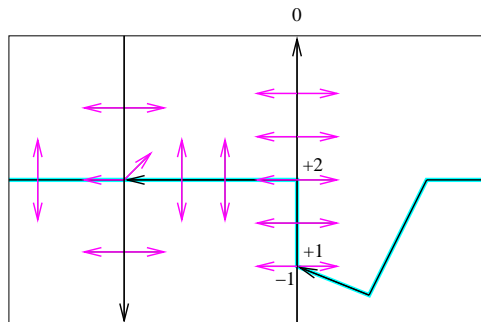
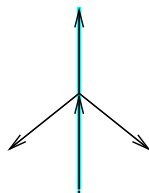

# Torus : 3rd proof of existence

Start with a 3-orientation

**Lemme** A middle walk ends on a middle cycle.

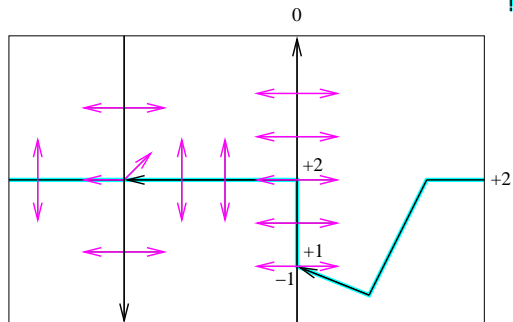
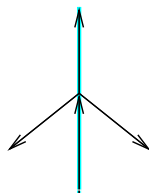

## Torus : 3rd proof of existence

Start with a 3-orientation

**Lemme** A middle walk ends on a middle cycle.

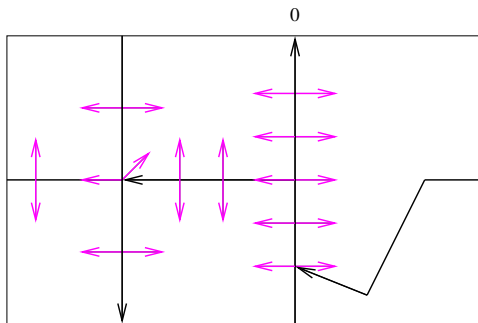
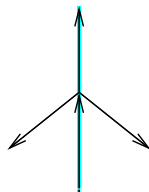



# Torus : 3rd proof of existence

Start with a 3-orientation

**Lemme** A middle walk ends on a middle cycle.

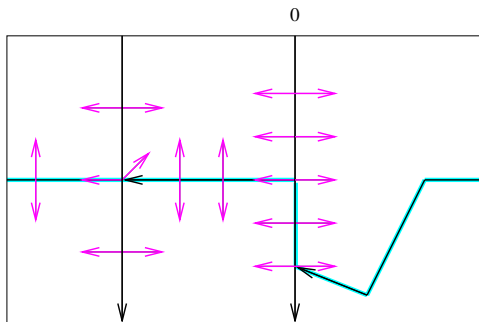
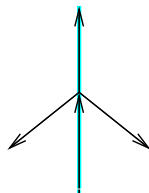



# Torus : 3rd proof of existence

Start with a 3-orientation

**Lemme** A middle walk ends on a middle cycle.

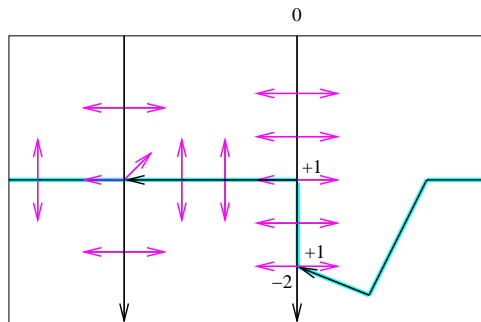
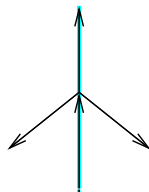

# Torus : 3rd proof of existence

Start with a 3-orientation

**Lemme** A middle walk ends on a middle cycle.

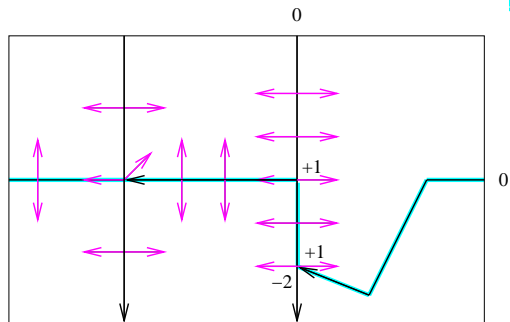
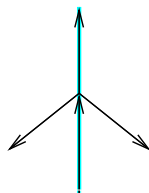

# Torus : 3rd proof of existence

Start with a 3-orientation

**Lemme** A middle walk ends on a middle cycle.

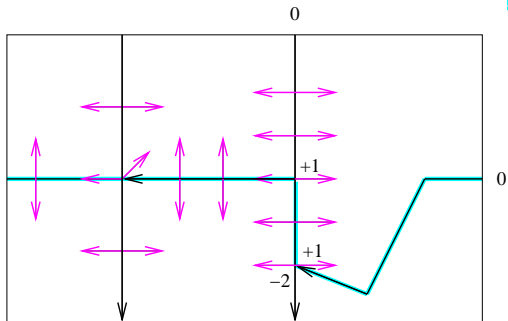
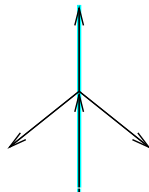

+ characterization theorem

# Torus : 3rd proof of existence

Start with a 3-orientation

**Lemme** A middle walk ends on a middle cycle.

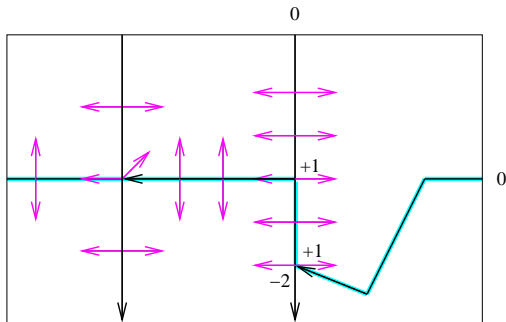
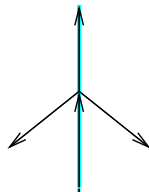

+ characterization theorem

$\implies$  Schnyder wood

# Orthogonal surfaces

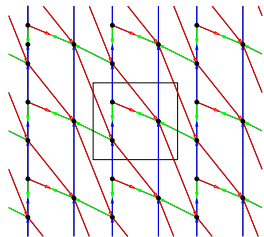
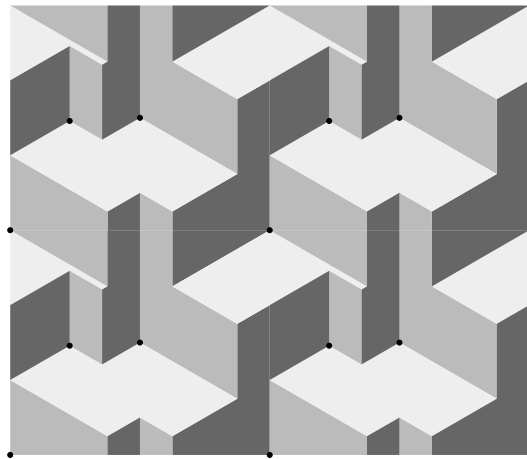

# Orthogonal surfaces

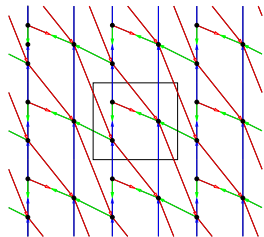
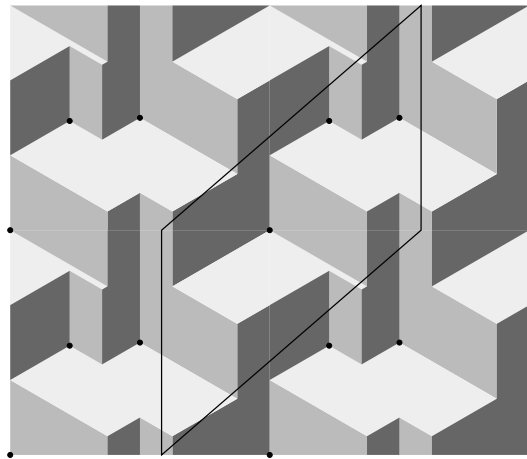

# Orthogonal surfaces

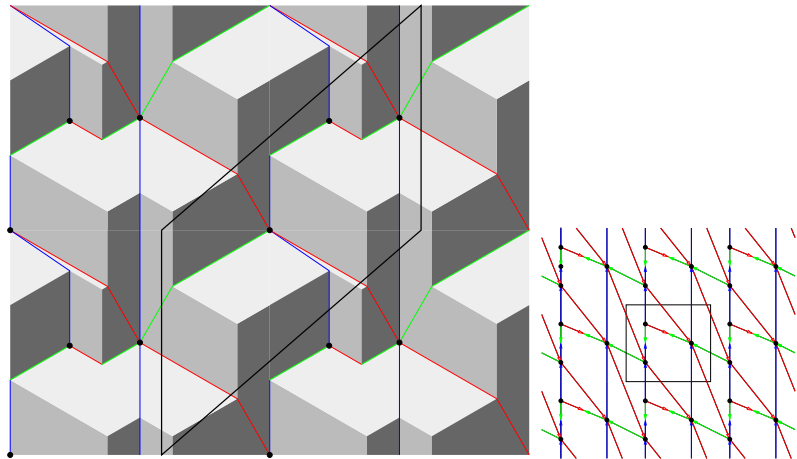

# Orthogonal surfaces

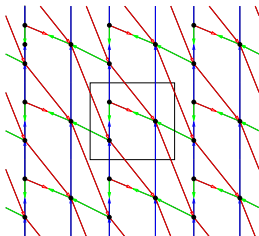
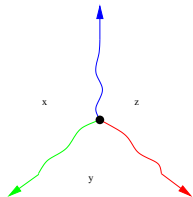
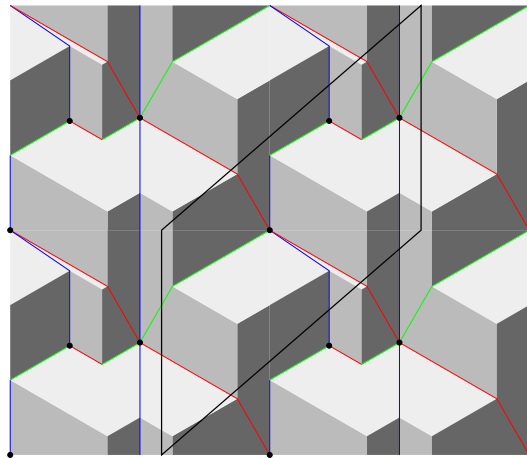



# Orthogonal surfaces

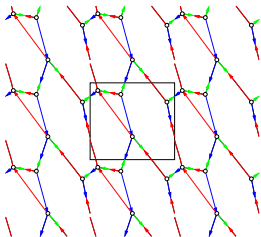
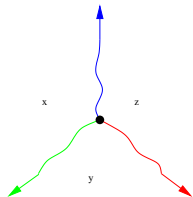
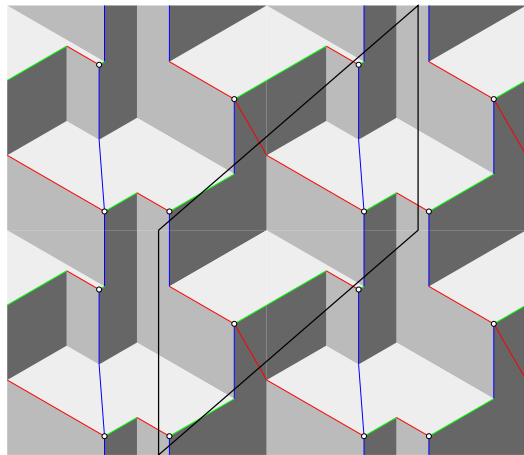

# Orthogonal surfaces

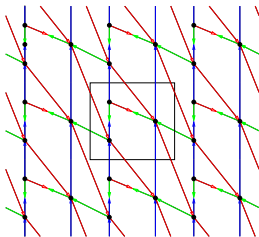
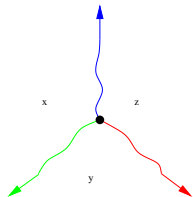
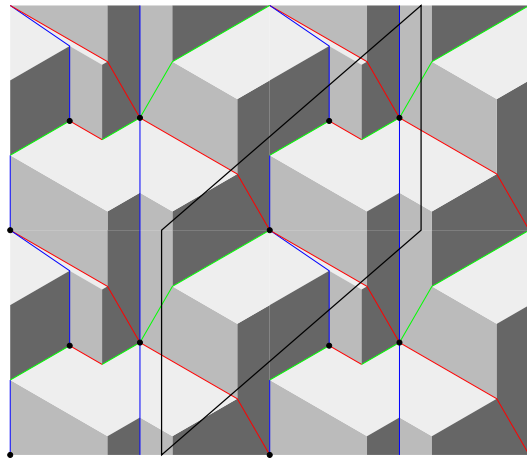

# Orthogonal surfaces

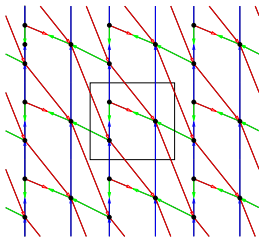
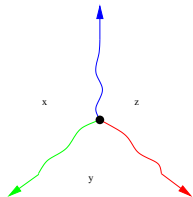
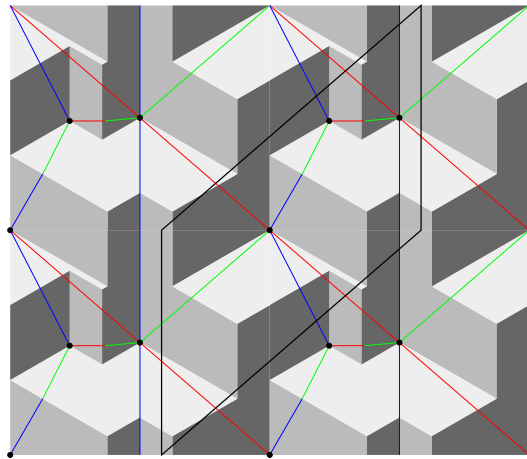

# Orthogonal surfaces

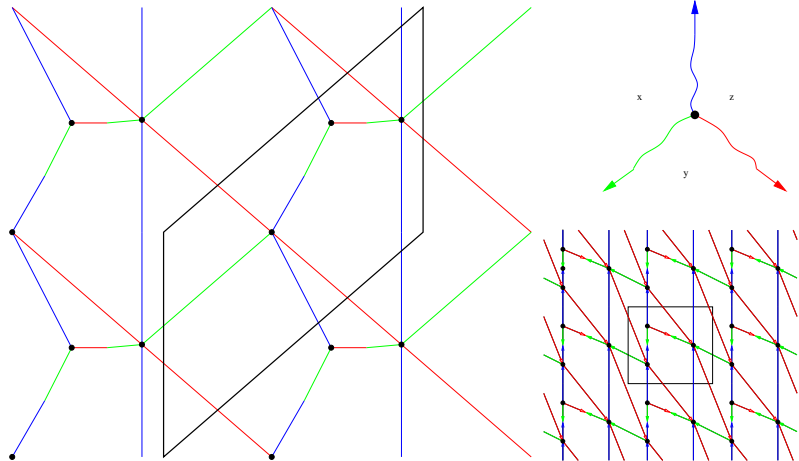

# Orthogonal surfaces

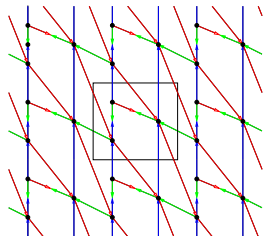
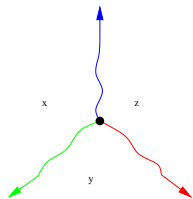
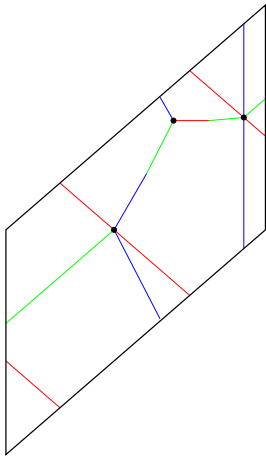

# Orthogonal surfaces

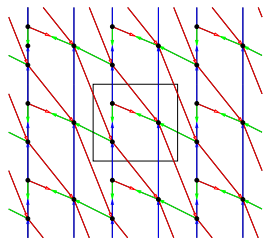
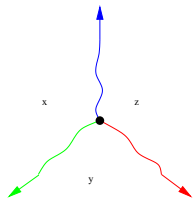
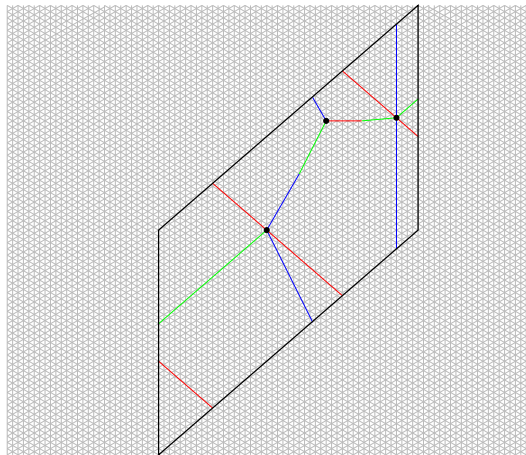

# Orthogonal surfaces

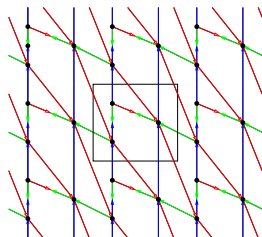
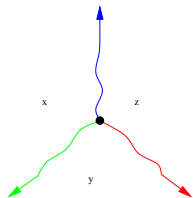
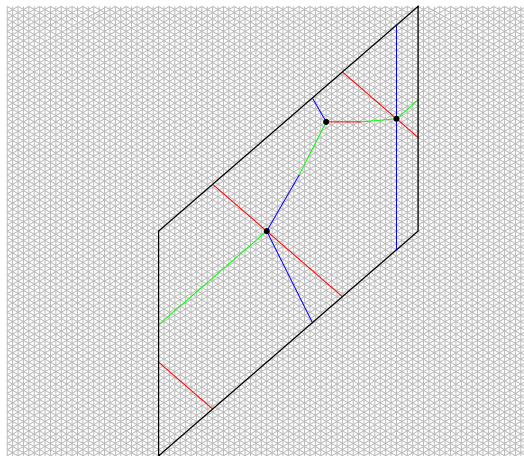

**Theorem** A simple toroidal map admits a straight line representation in a grid of size  $\mathcal{O}(n^2) \times \mathcal{O}(n^2)$

# Open questions



## Open questions

- ▶ Existence for higher genus ?

## Open questions

- ▶ Existence for higher genus ?

**Conjecture** Triangulation on an **oriented** surface  $\implies$  orientation and coloring of the edges such that every vertex satisfies  $k \geq 1$  times the Schnyder property

## Open questions

- ▶ Existence for higher genus ?

**Conjecture** Triangulation on an **oriented** surface  $\implies$  orientation and coloring of the edges such that every vertex satisfies  $k \geq 1$  times the Schnyder property

- ▶ A kind of crossing properties ?

## Open questions

- ▶ Existence for higher genus ?

**Conjecture** Triangulation on an **oriented** surface  $\implies$  orientation and coloring of the edges such that every vertex satisfies  $k \geq 1$  times the Schnyder property

- ▶ A kind of crossing properties ?

**Question** Maximum number of non homotopic and non contractible closed curves such that they pairwise intersect on at most one point ?

## Open questions

- ▶ Existence for higher genus ?

**Conjecture** Triangulation on an **oriented** surface  $\implies$  orientation and coloring of the edges such that every vertex satisfies  $k \geq 1$  times the Schnyder property

- ▶ A kind of crossing properties ?

**Question** Maximum number of non homotopic and non contractible closed curves such that they pairwise intersect on at most one point ?

- ▶ Color connectivity ?

## Open questions

- ▶ Existence for higher genus ?

**Conjecture** Triangulation on an **oriented** surface  $\implies$  orientation and coloring of the edges such that every vertex satisfies  $k \geq 1$  times the Schnyder property

- ▶ A kind of crossing properties ?

**Question** Maximum number of non homotopic and non contractible closed curves such that they pairwise intersect on at most one point ?

- ▶ Color connectivity ?

**Question** One component for each color for **simple** triangulations ?

## Open questions

- ▶ Existence for higher genus ?

**Conjecture** Triangulation on an **oriented** surface  $\implies$  orientation and coloring of the edges such that every vertex satisfies  $k \geq 1$  times the Schnyder property

- ▶ A kind of crossing properties ?

**Question** Maximum number of non homotopic and non contractible closed curves such that they pairwise intersect on at most one point ?

- ▶ Color connectivity ?

**Question** One component for each color for **simple** triangulations ?

- ▶ Other applications ?

## Open questions

- ▶ Existence for higher genus ?

**Conjecture** Triangulation on an **oriented** surface  $\implies$  orientation and coloring of the edges such that every vertex satisfies  $k \geq 1$  times the Schnyder property

- ▶ A kind of crossing properties ?

**Question** Maximum number of non homotopic and non contractible closed curves such that they pairwise intersect on at most one point ?

- ▶ Color connectivity ?

**Question** One component for each color for **simple** triangulations ?

- ▶ Other applications ?

Enumeration, Compression, Spanners, . . .