

Baxter permutations and meanders

Éric Fusy (LIX, École Polytechnique)

Meanders on two lines

- A 2-line meander

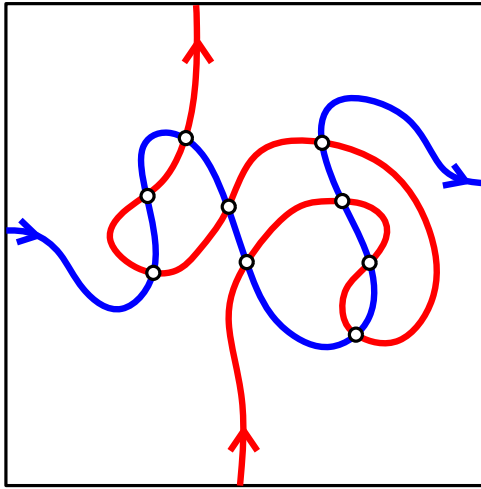

encoded by a permutation

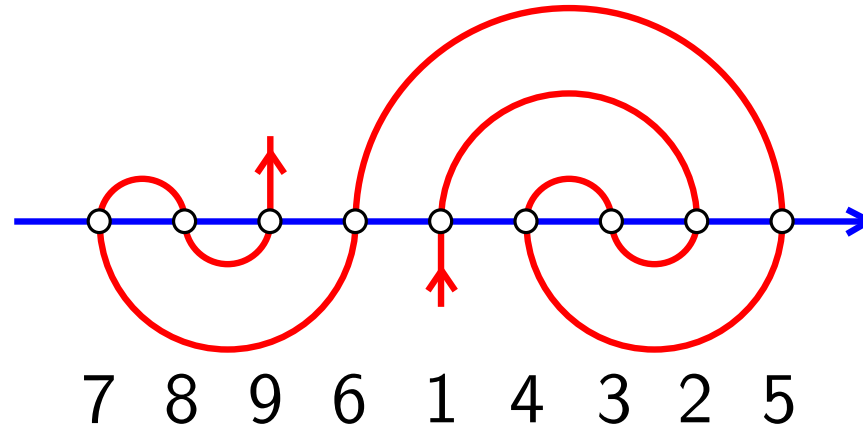

Meanders on two lines

- A 2-line meander

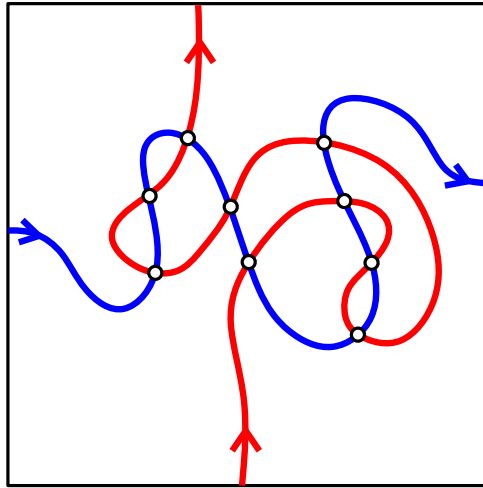

encoded by a permutation

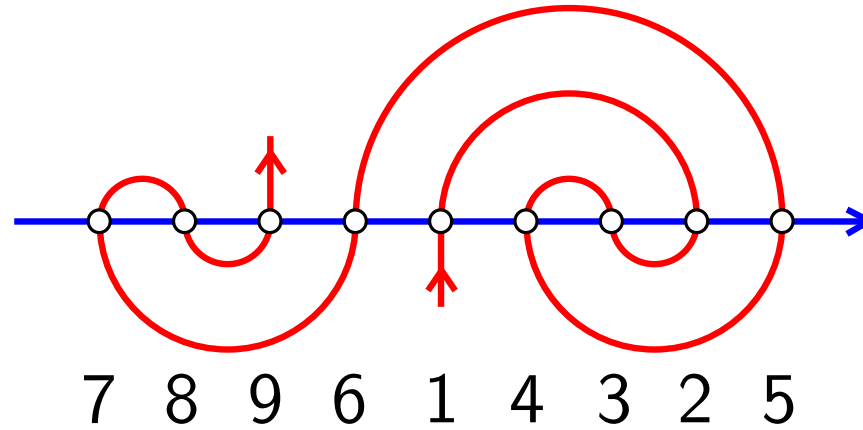

- Monotone 2-line meander:

can be obtained from two monotone lines (one in x , the other in y)

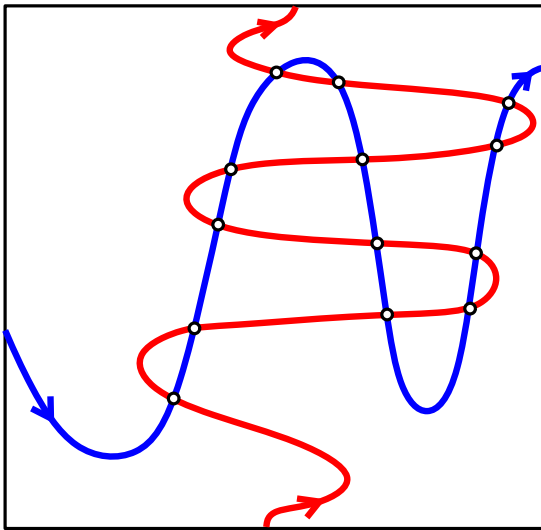

Meanders on two lines

- A 2-line meander

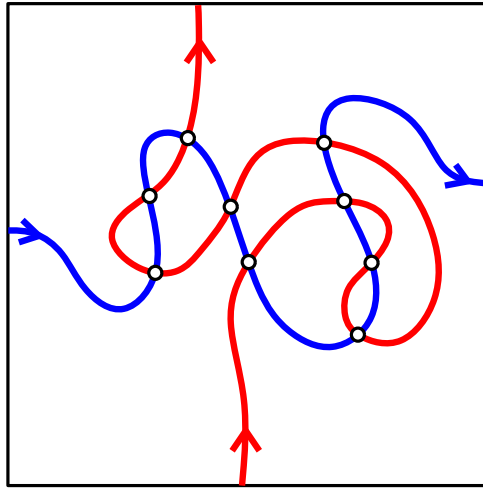

encoded by a permutation

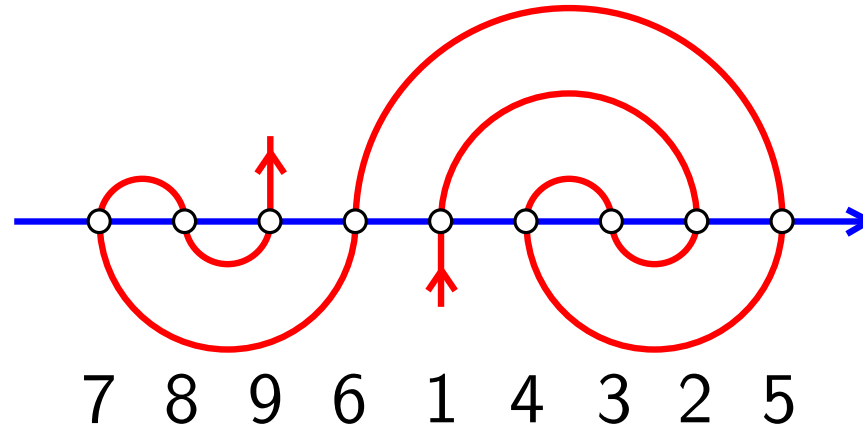

- Monotone 2-line meander:
can be obtained from two monotone lines (one in x , the other in y)

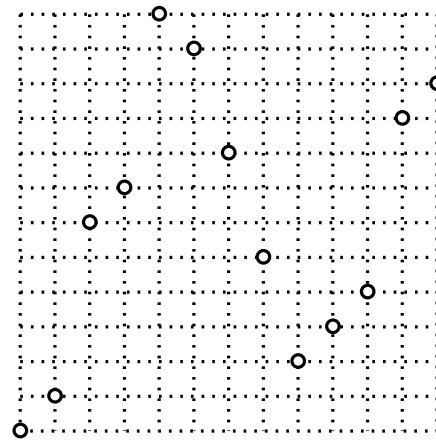
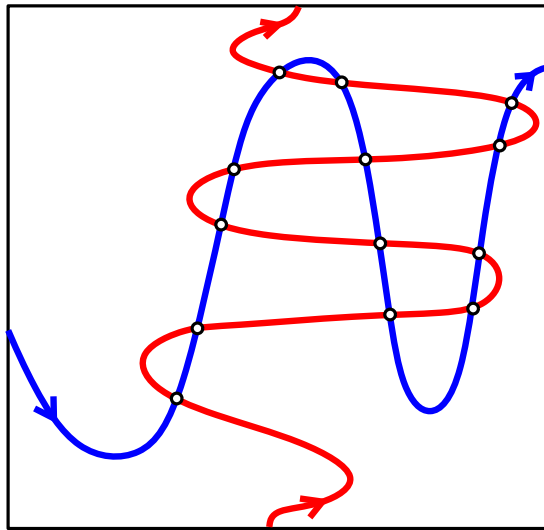

associated
permutation

Meanders on two lines

- A 2-line meander

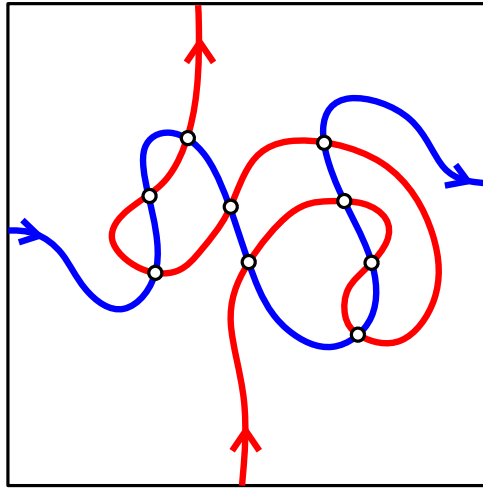

encoded by a permutation

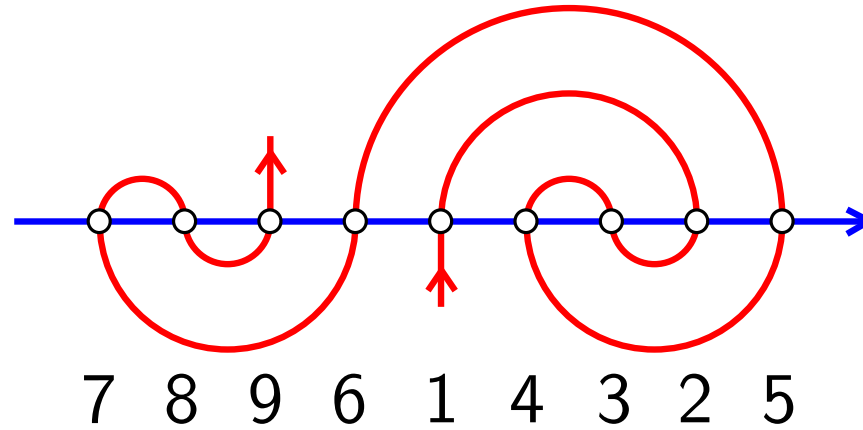

- Monotone 2-line meander:
can be obtained from two monotone lines (one in x , the other in y)

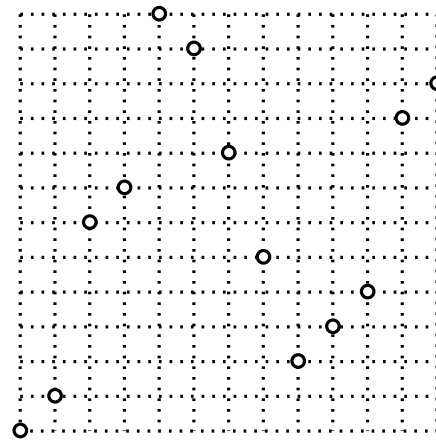
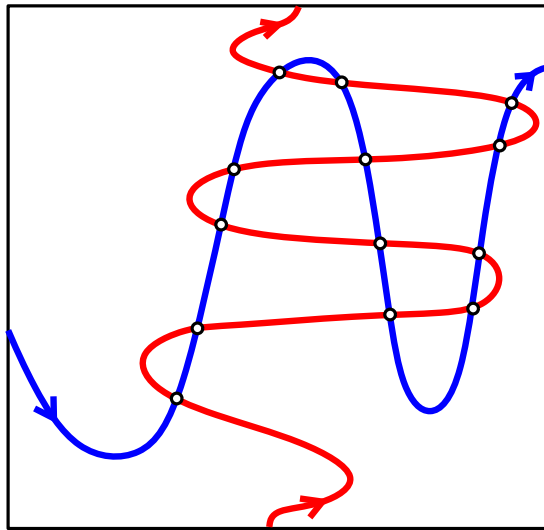

associated
permutation

Which permutations can be obtained this way ?

Meanders on two lines

- A 2-line meander

encoded by a permutation

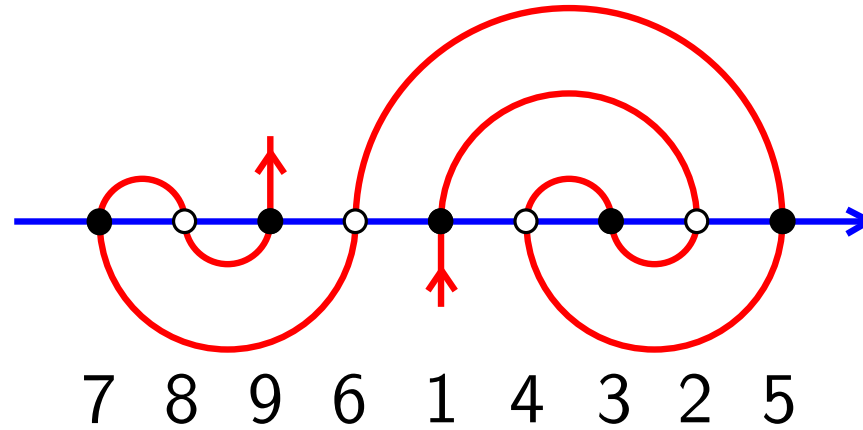
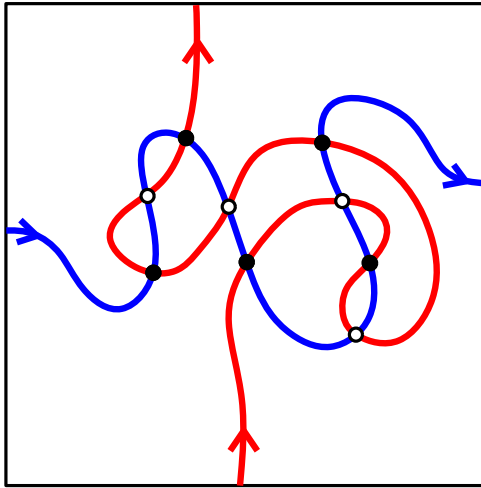

- Monotone 2-line meander:

can be obtained from two monotone lines (one in x , the other in y)

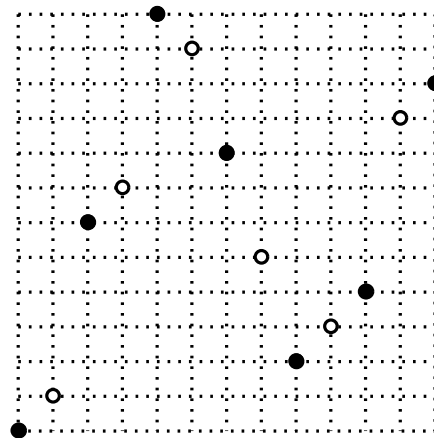
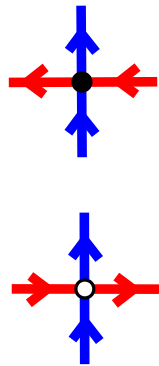
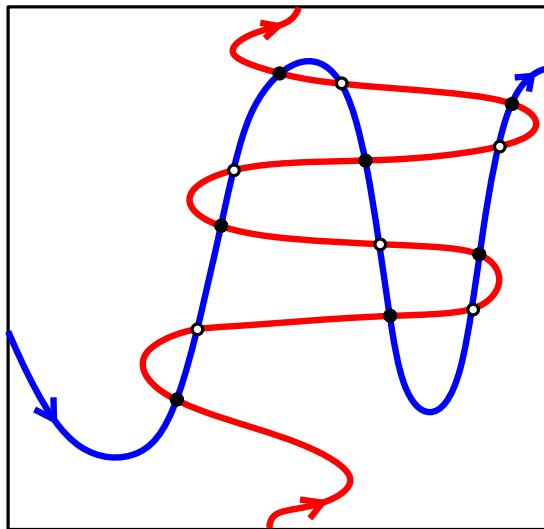

associated permutation

Which permutations can be obtained this way ?

Meanders on two lines

- A 2-line meander

encoded by a permutation

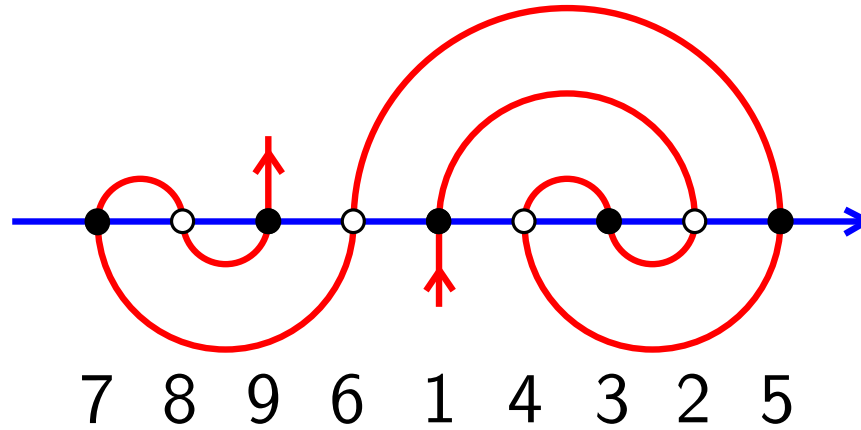
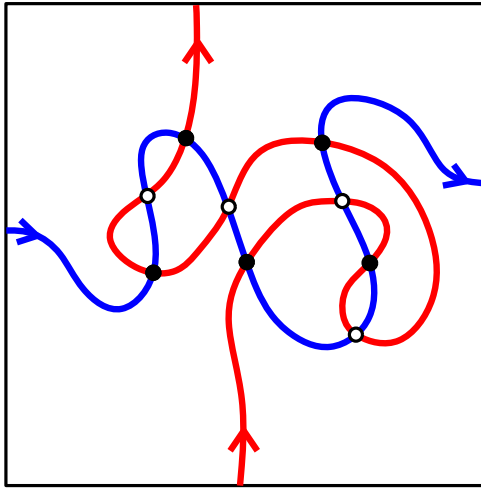

- Monotone 2-line meander:

can be obtained from two monotone lines (one in x , the other in y)

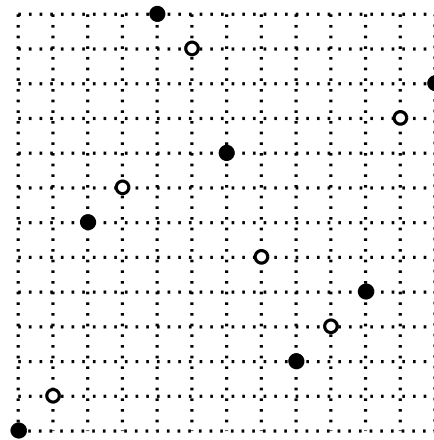
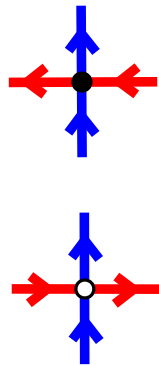
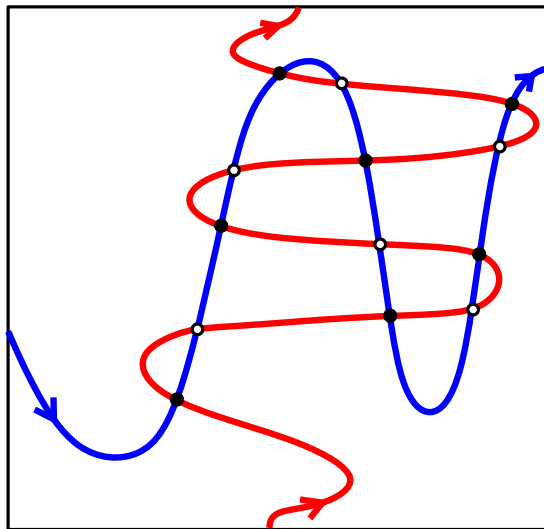

associated permutation

Which permutations can be obtained this way ?

Maps odd numbers to odd numbers, even numbers to even numbers

Permutations for monotone 2-line meanders

[Baxter'64, Boyce'68&'81]

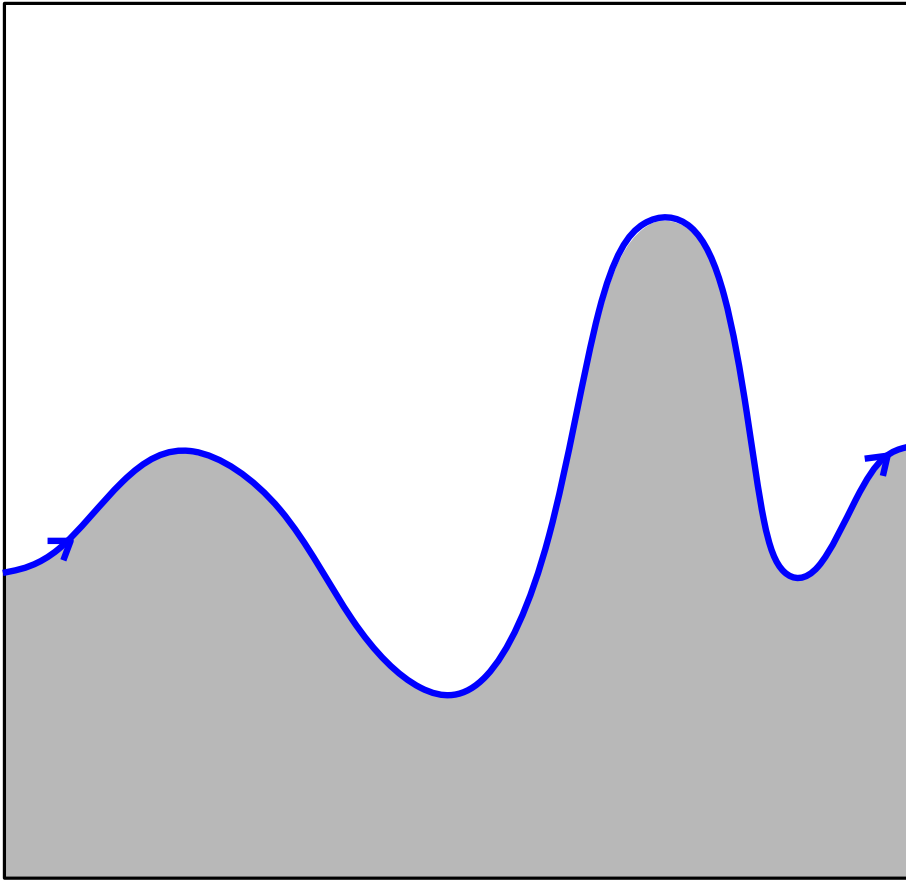

Permutations for monotone 2-line meanders

[Baxter'64, Boyce'68&'81]

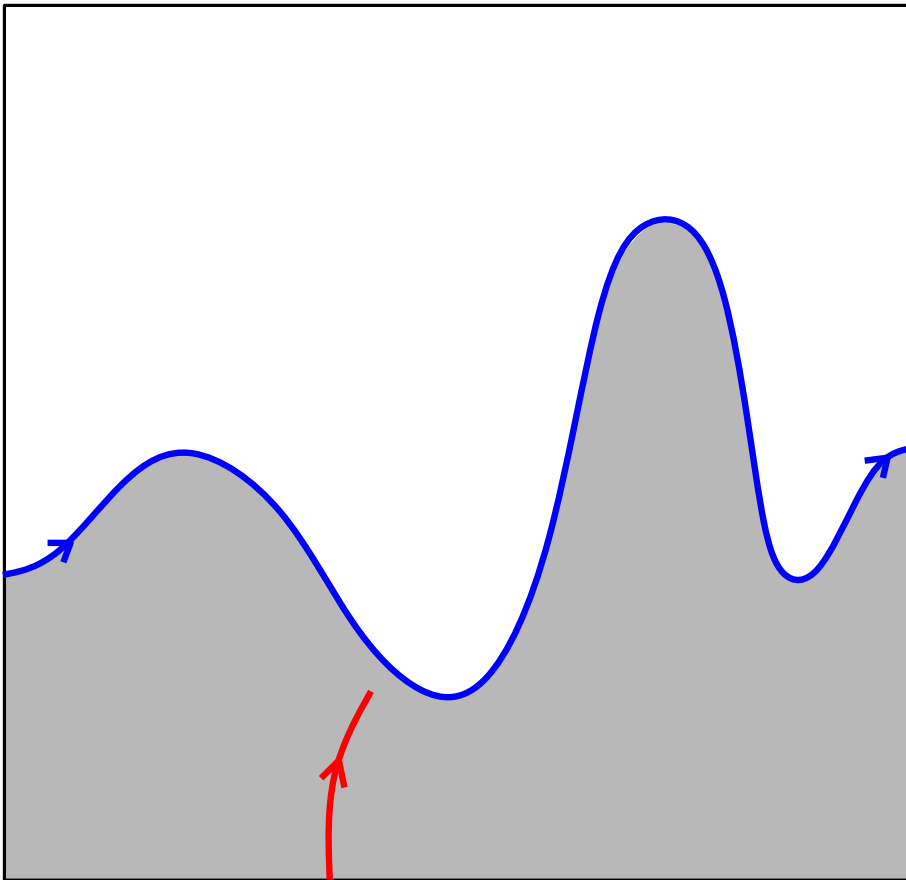

Permutations for monotone 2-line meanders

[Baxter'64, Boyce'68&'81]

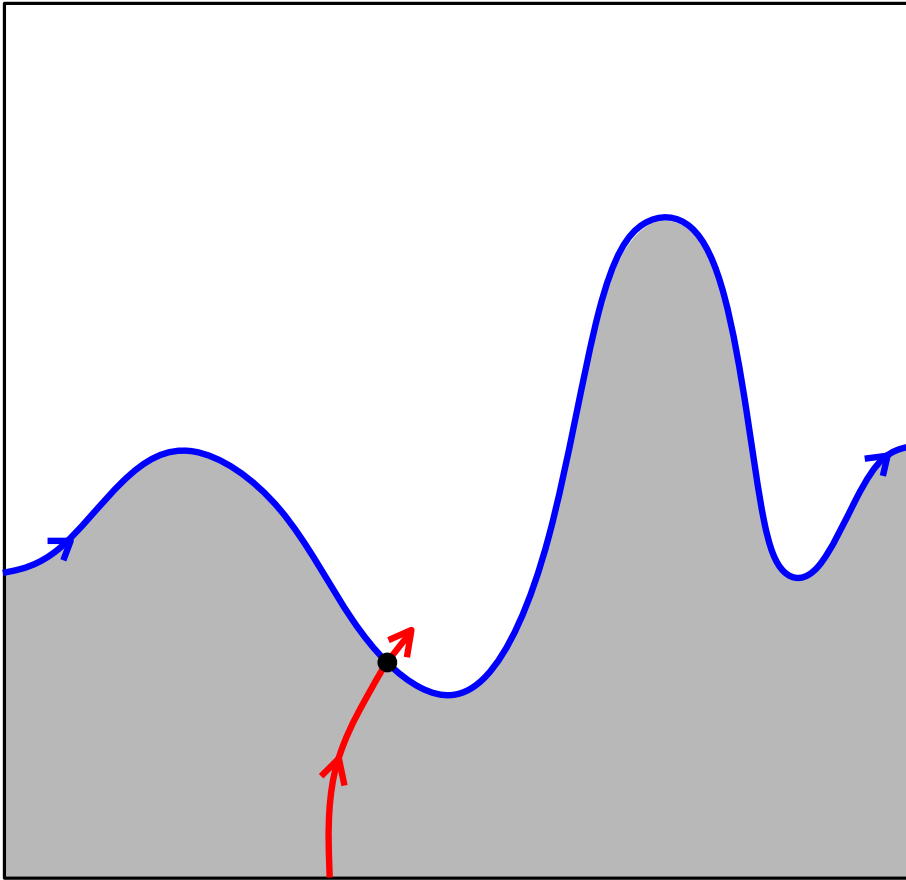

Permutations for monotone 2-line meanders

[Baxter'64, Boyce'68&'81]

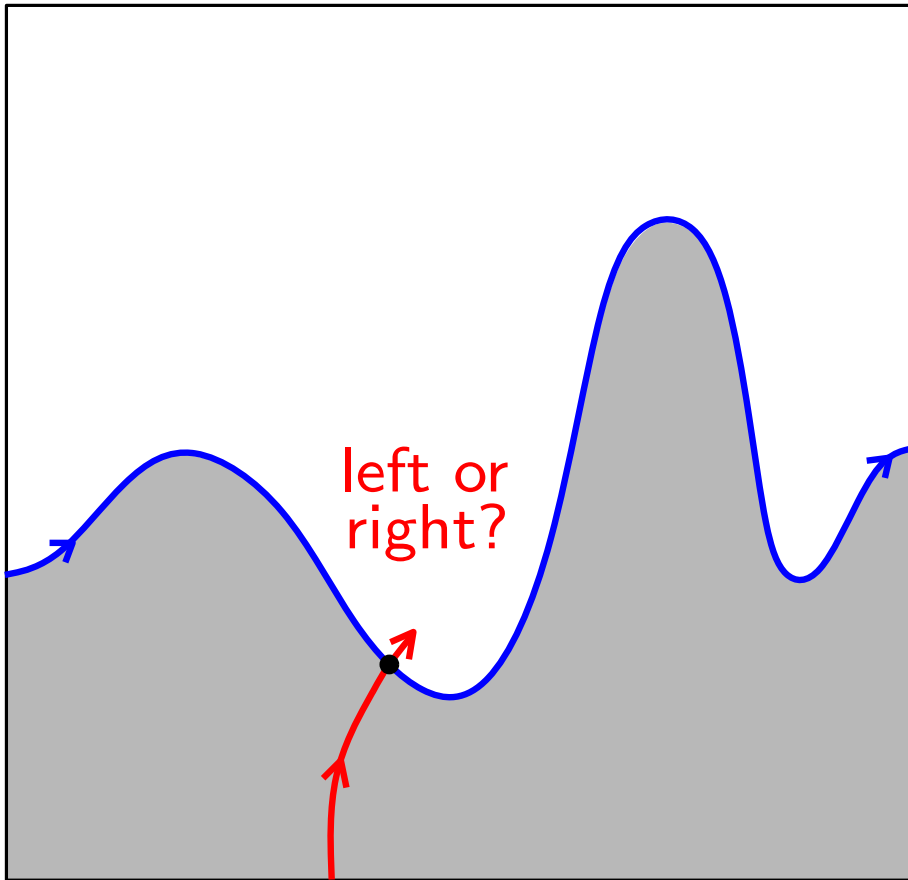

Permutations for monotone 2-line meanders

[Baxter'64, Boyce'68&'81]

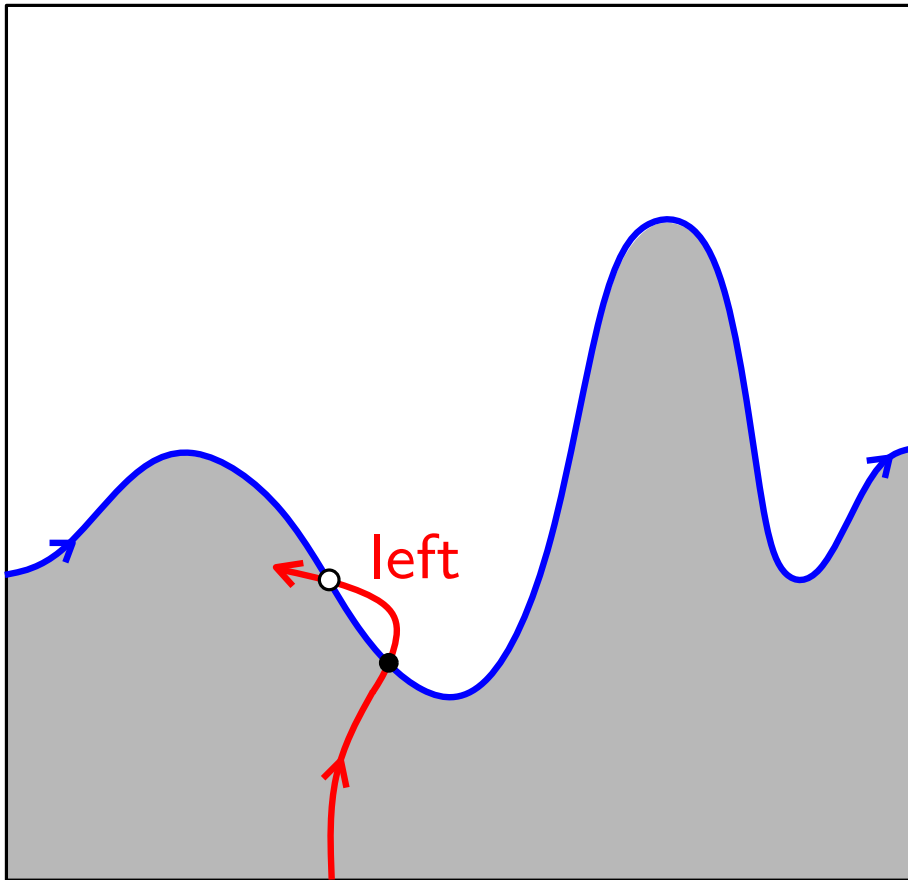

Permutations for monotone 2-line meanders

[Baxter'64, Boyce'68&'81]

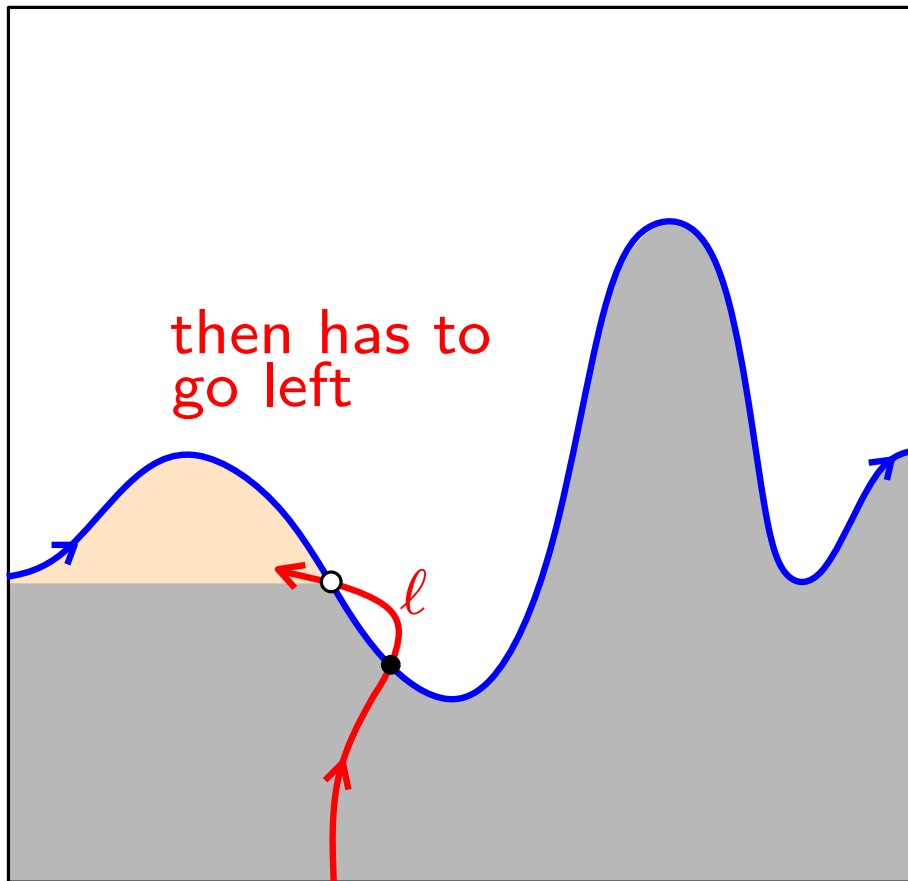

Permutations for monotone 2-line meanders

[Baxter'64, Boyce'68&'81]

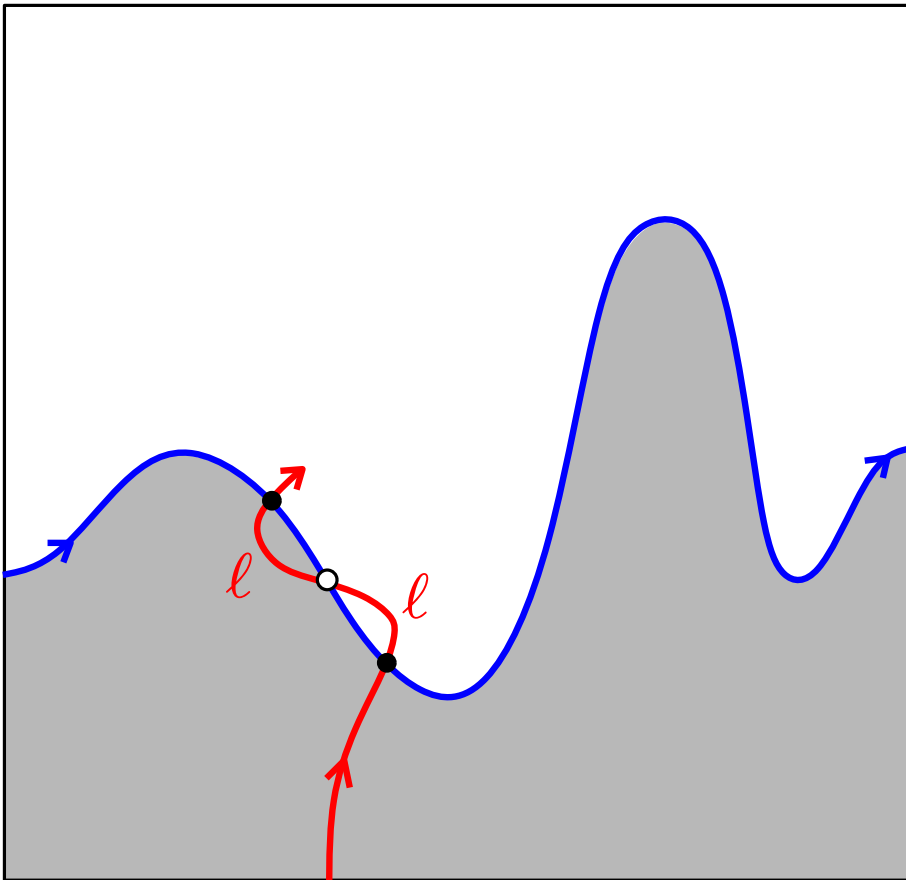

Permutations for monotone 2-line meanders

[Baxter'64, Boyce'68&'81]

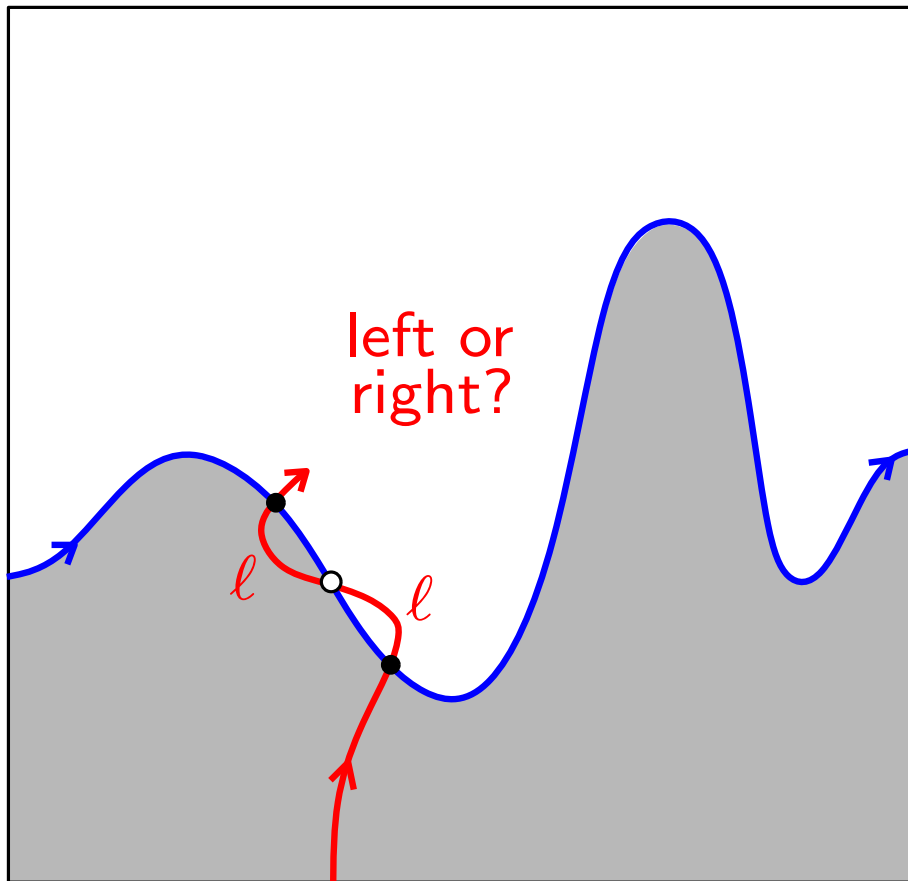

Permutations for monotone 2-line meanders

[Baxter'64, Boyce'68&'81]

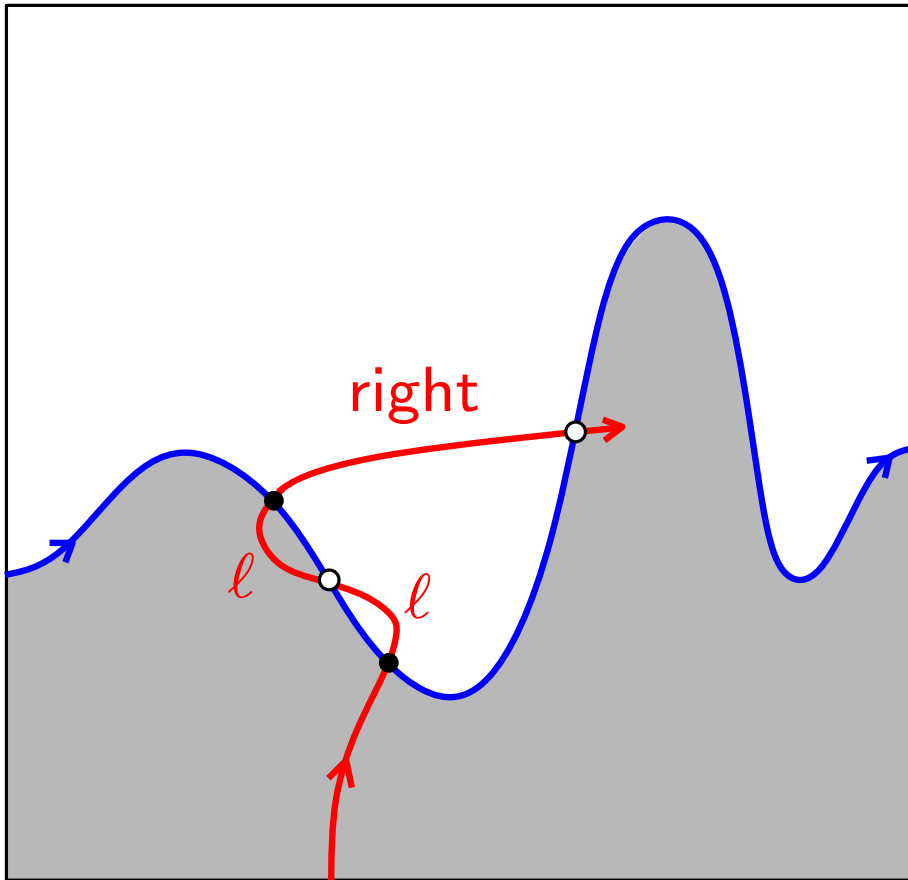

Permutations for monotone 2-line meanders

[Baxter'64, Boyce'68&'81]

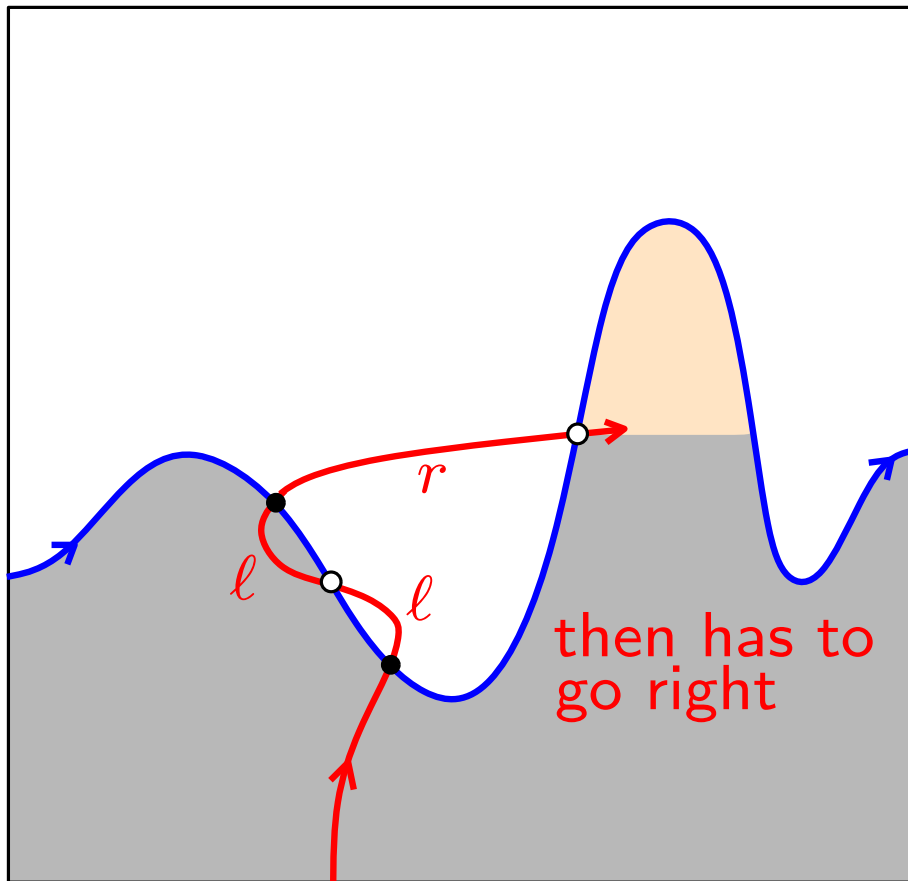

Permutations for monotone 2-line meanders

[Baxter'64, Boyce'68&'81]

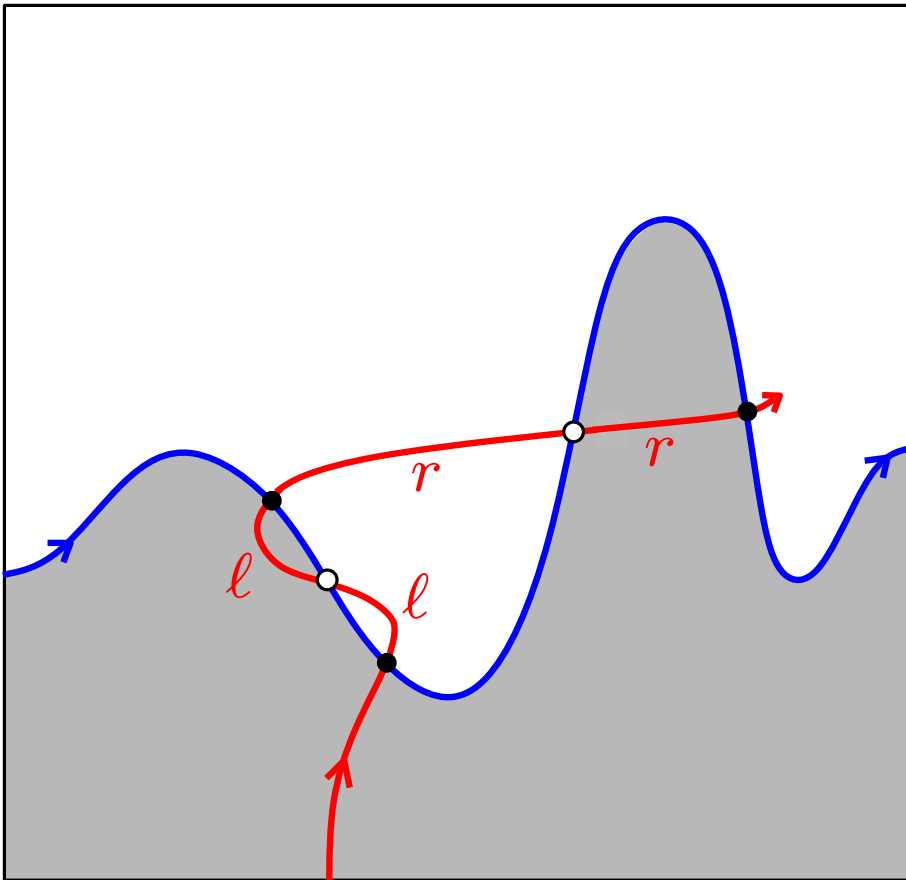

Permutations for monotone 2-line meanders

[Baxter'64, Boyce'68&'81]

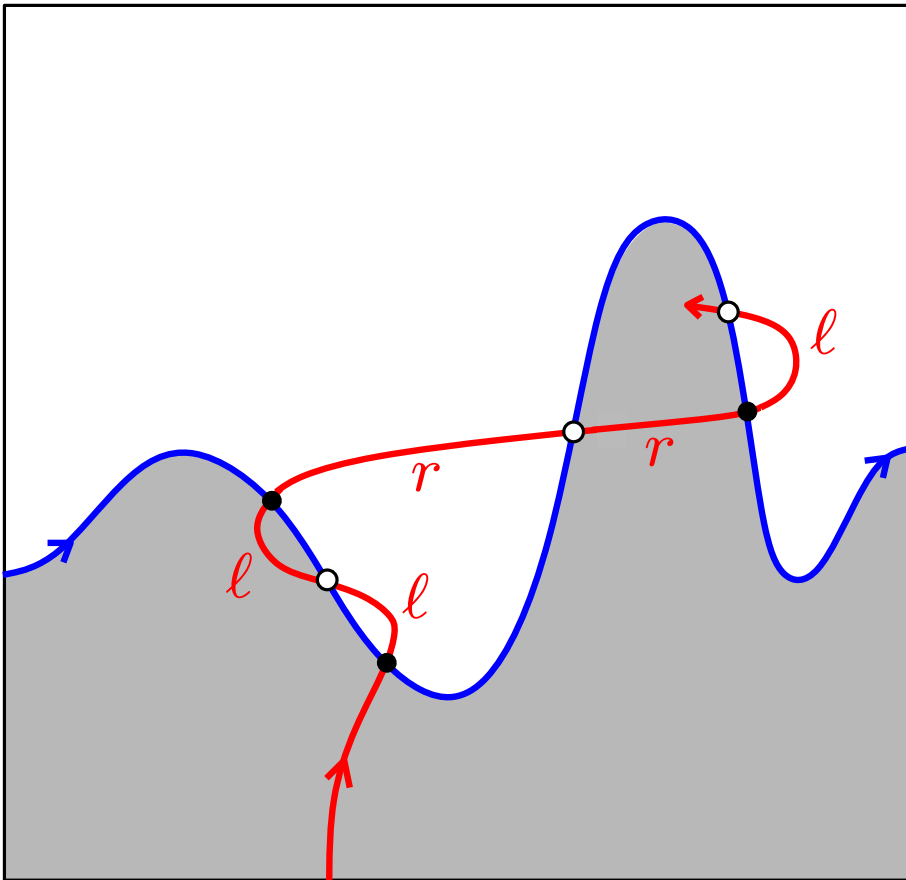

Permutations for monotone 2-line meanders

[Baxter'64, Boyce'68&'81]

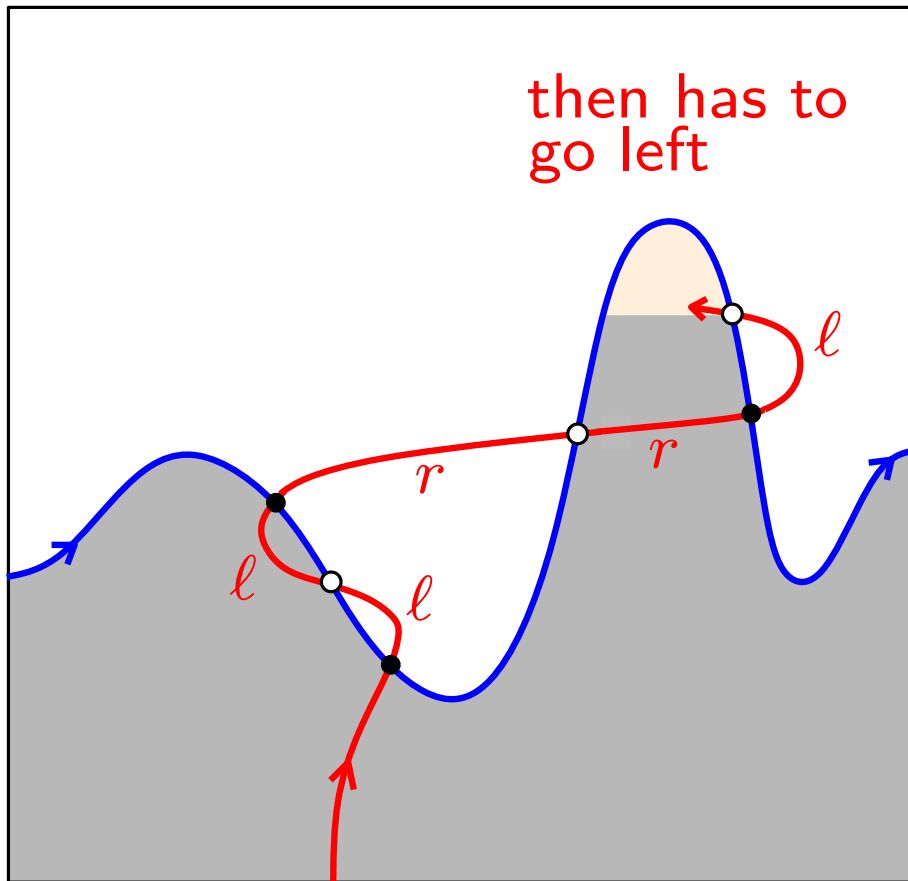

Permutations for monotone 2-line meanders

[Baxter'64, Boyce'68&'81]

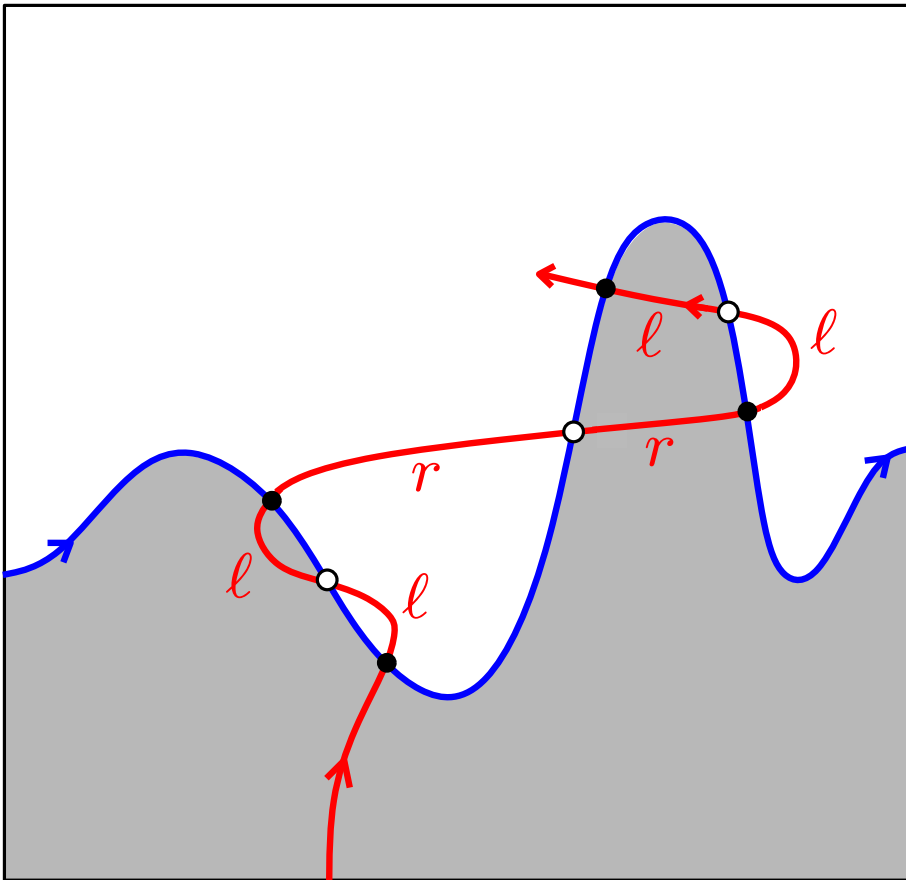

Permutations for monotone 2-line meanders

[Baxter'64, Boyce'68&'81]

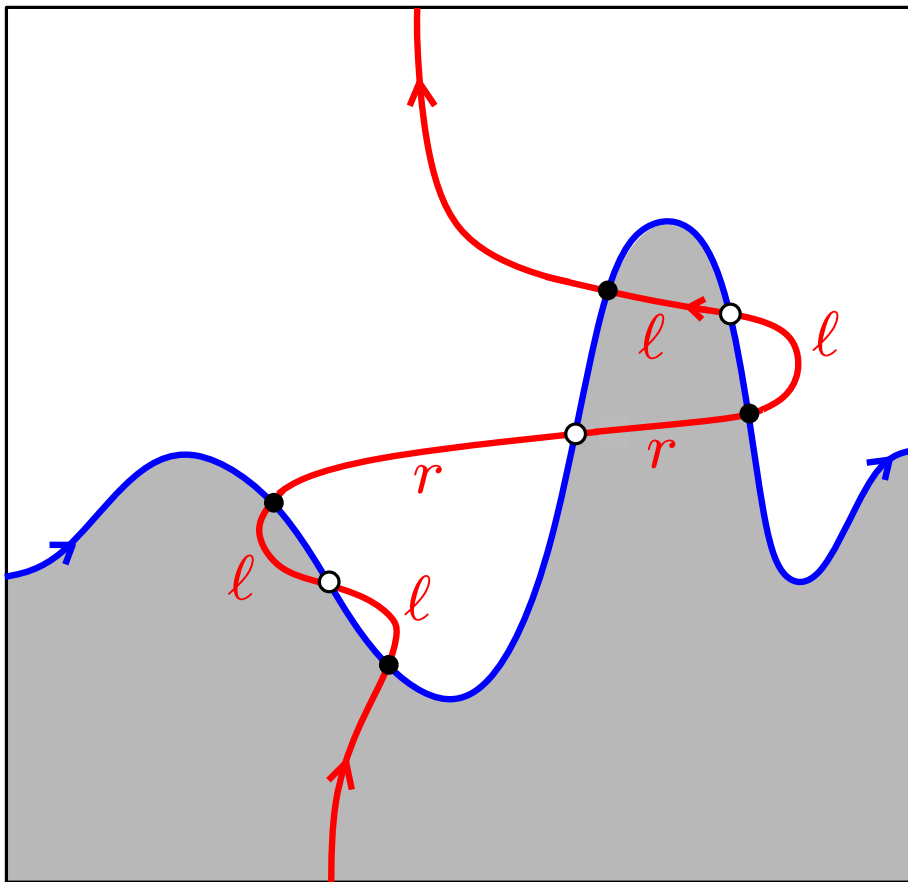

white points are either:



rising

descending

Permutations for monotone 2-line meanders

[Baxter'64, Boyce'68&'81]

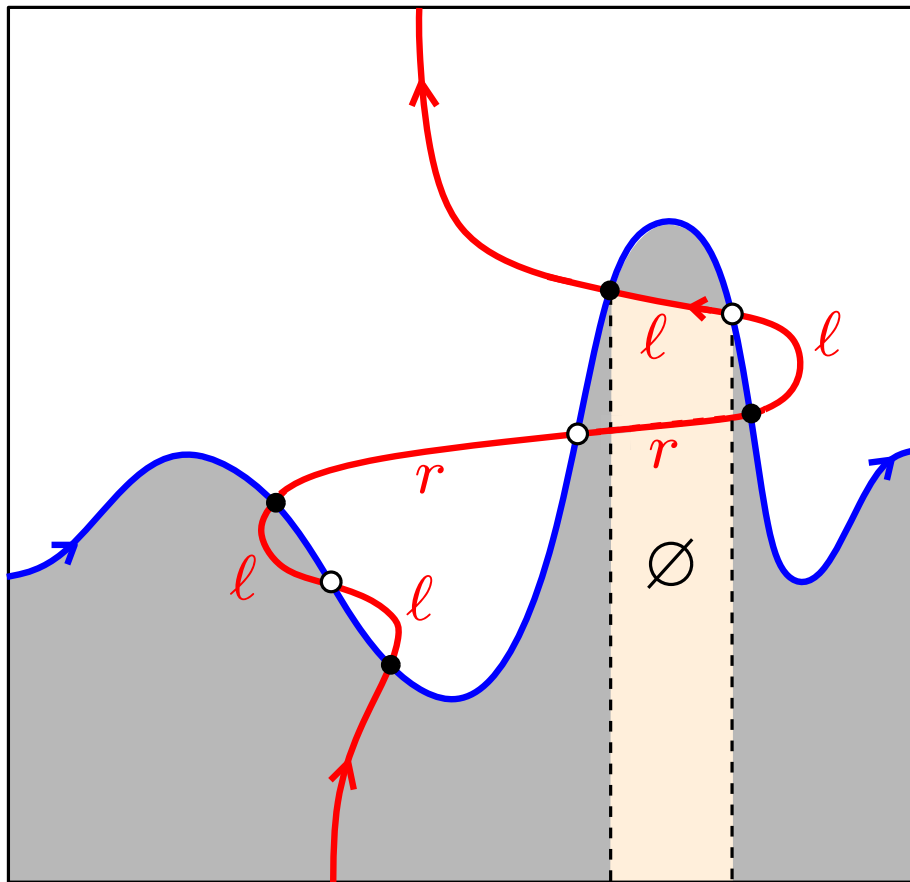

white points are either:

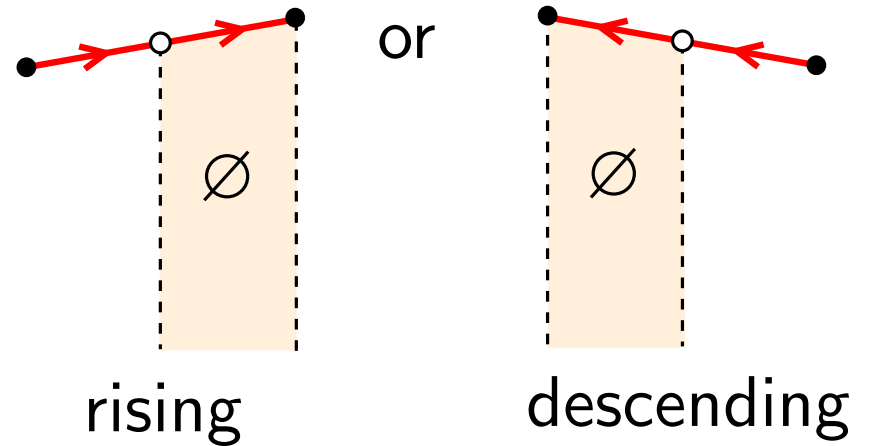

Permutations for monotone 2-line meanders

[Baxter'64, Boyce'68&'81]

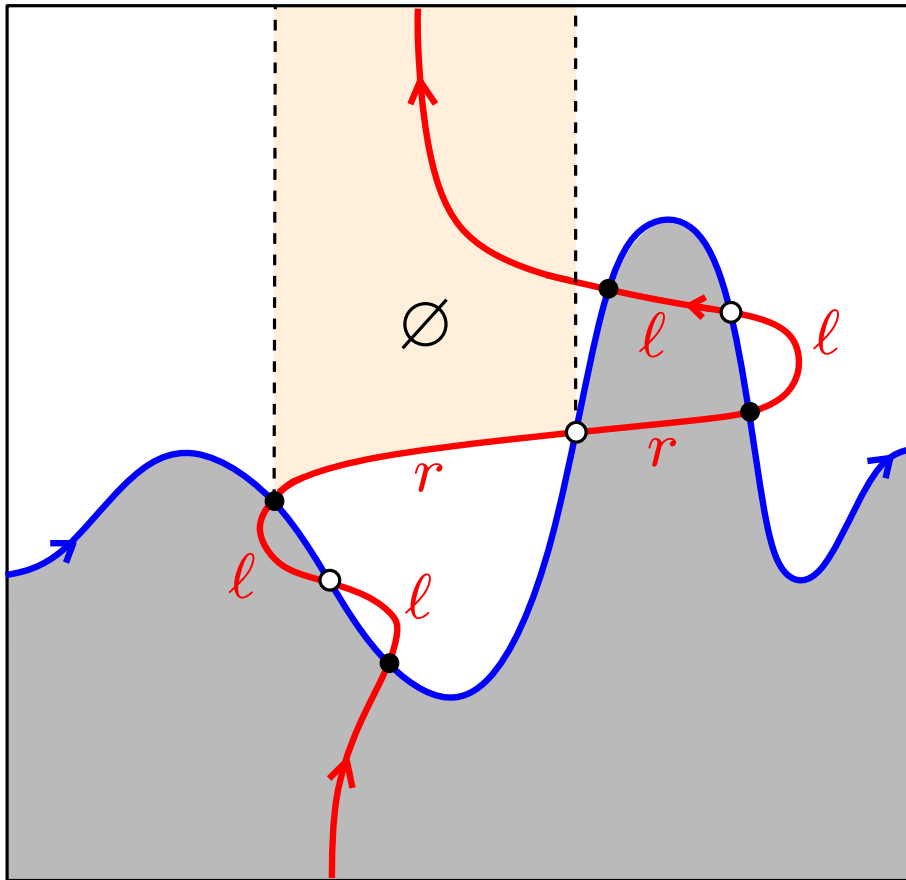

white points are either:

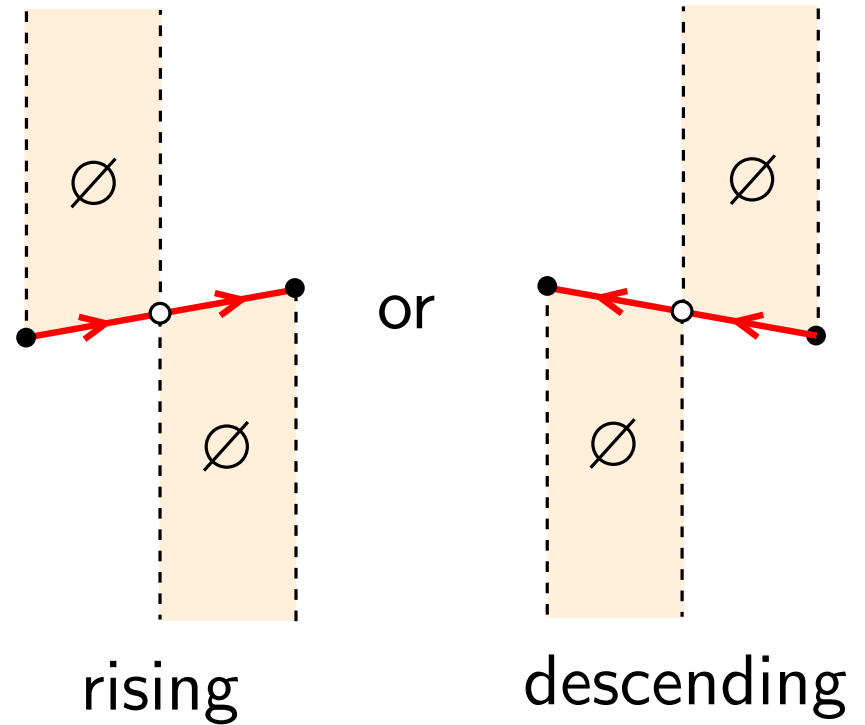

Permutations for monotone 2-line meanders

[Baxter'64, Boyce'68&'81]

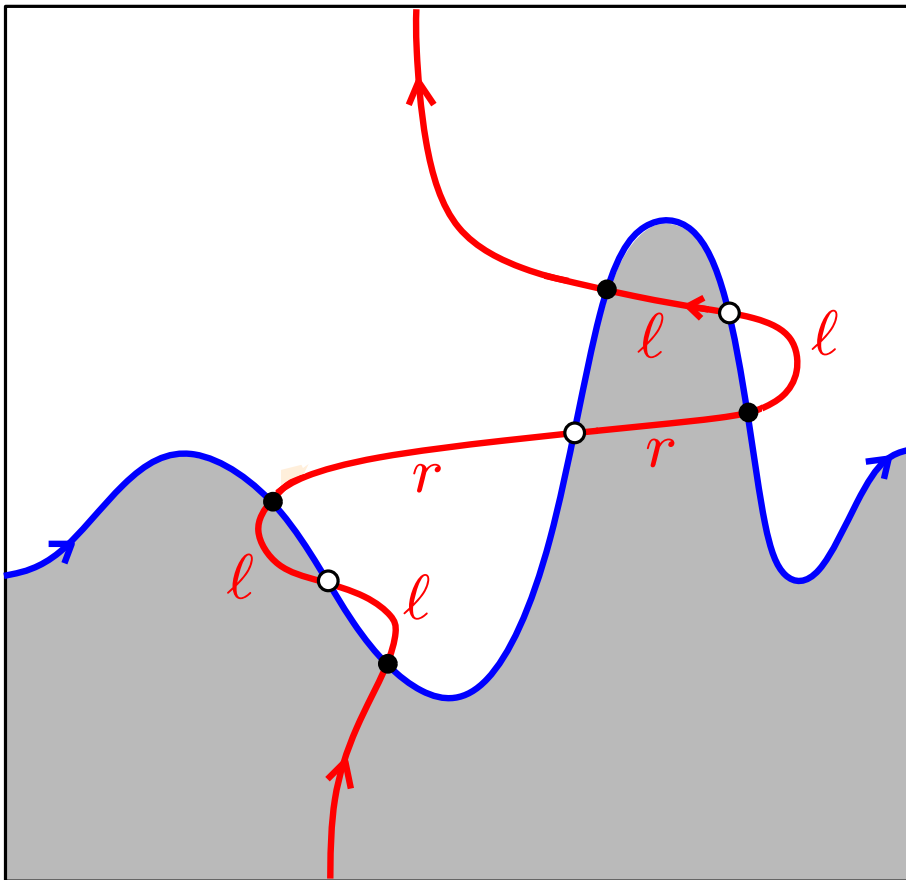

white points are either:

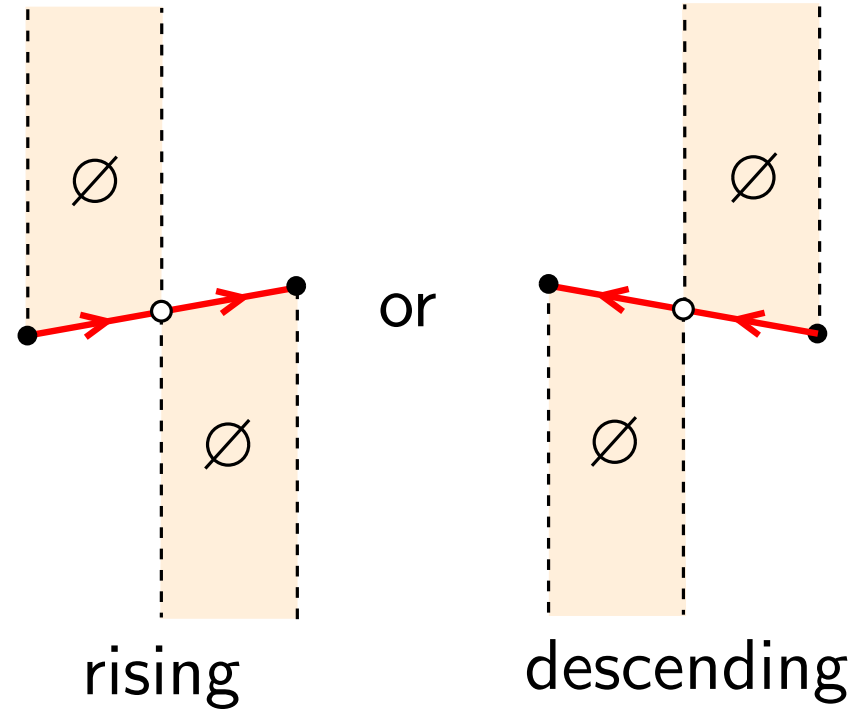

Permutations for monotone 2-line meanders

[Baxter'64, Boyce'68&'81]

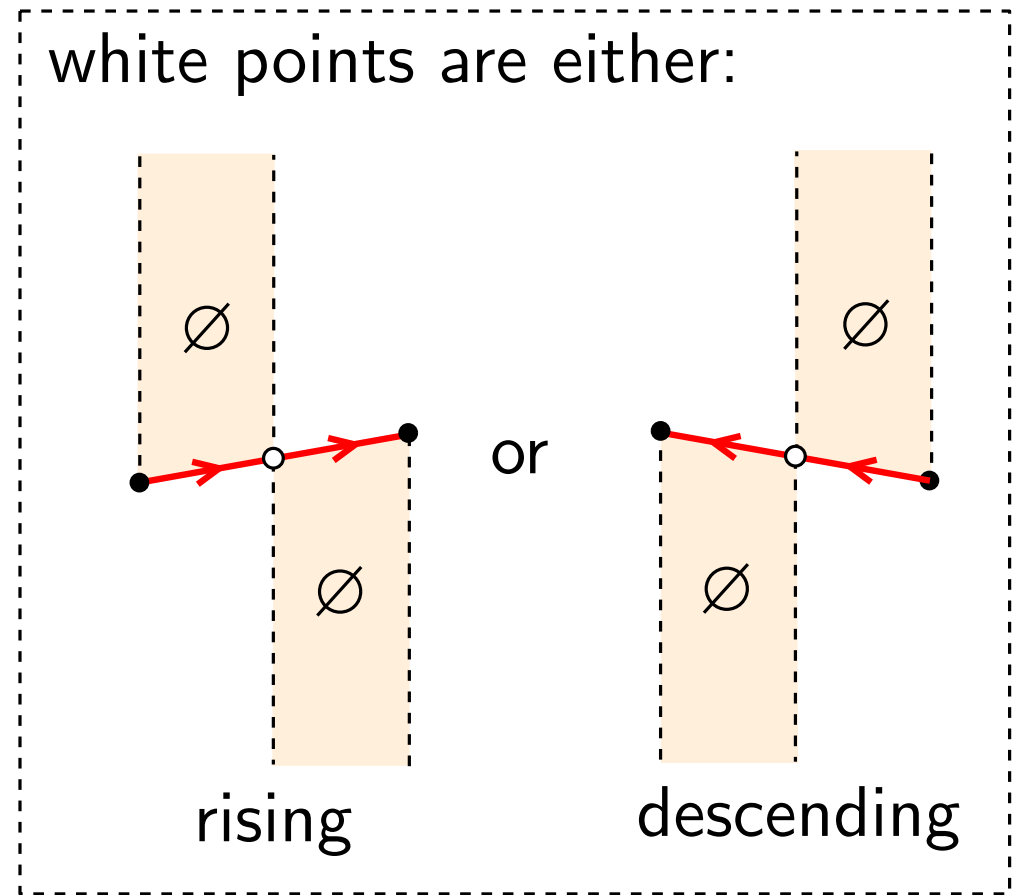
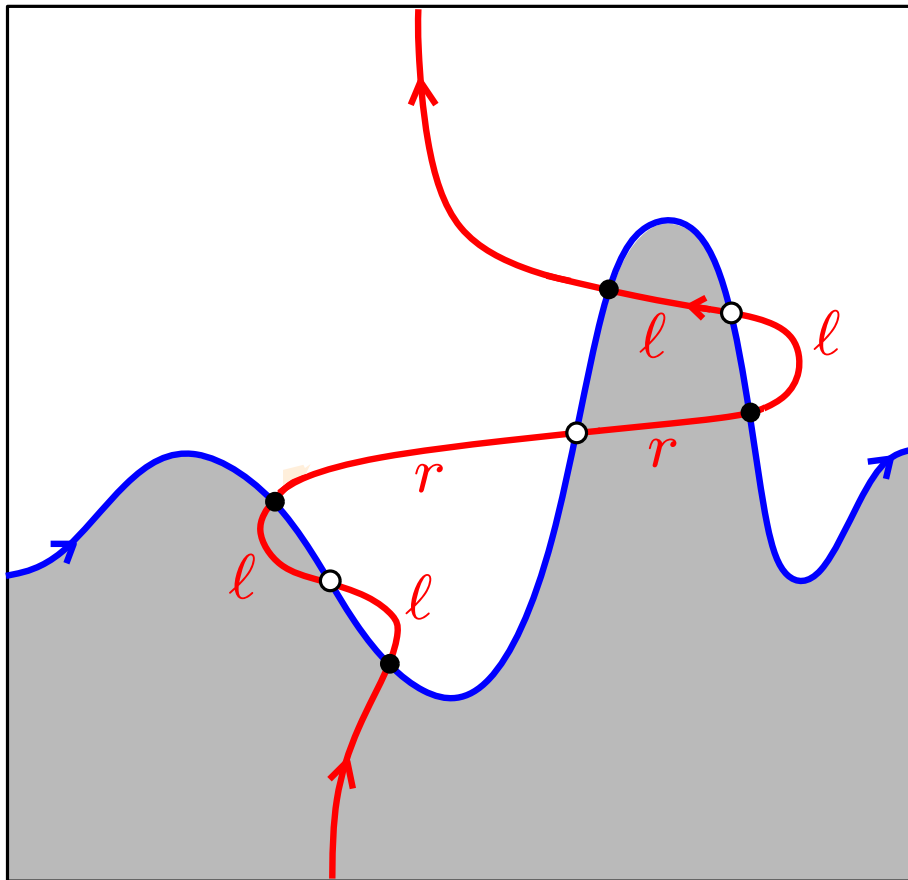

Permutations mapping even to even, odd to odd, and satisfying condition shown on the right are called **complete Baxter permutations**

Permutations for monotone 2-line meanders

[Baxter'64, Boyce'68&'81]

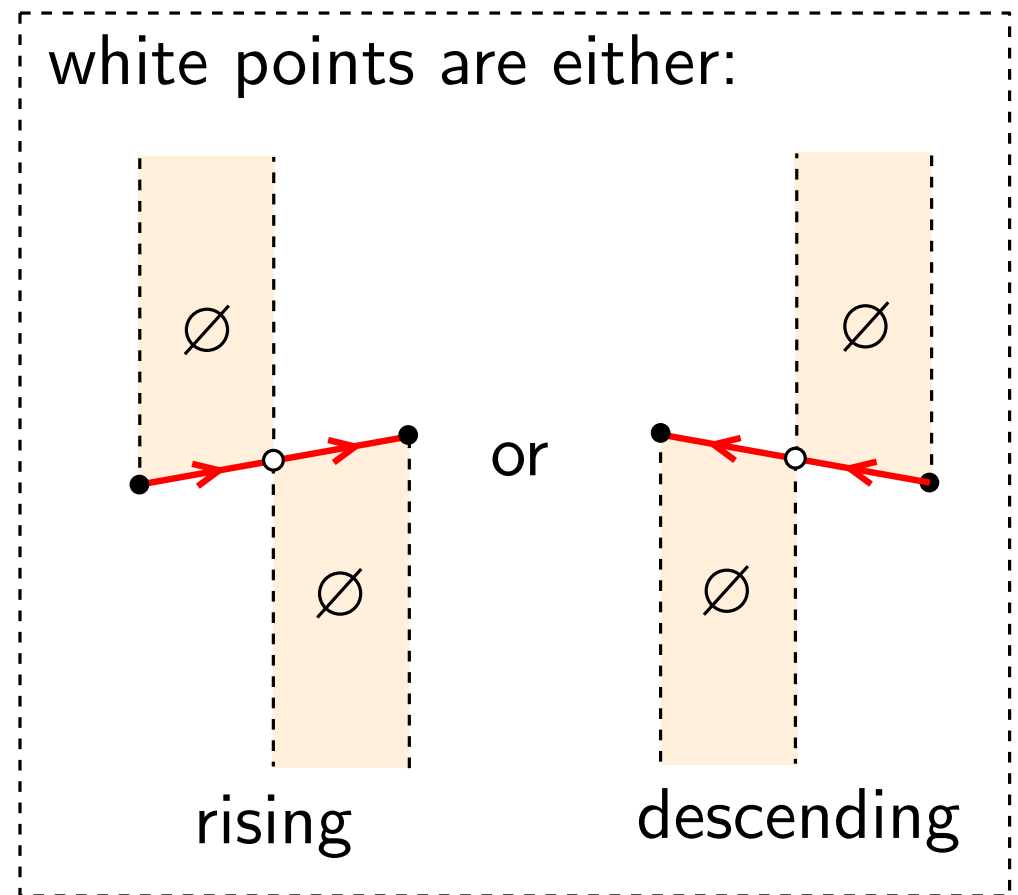
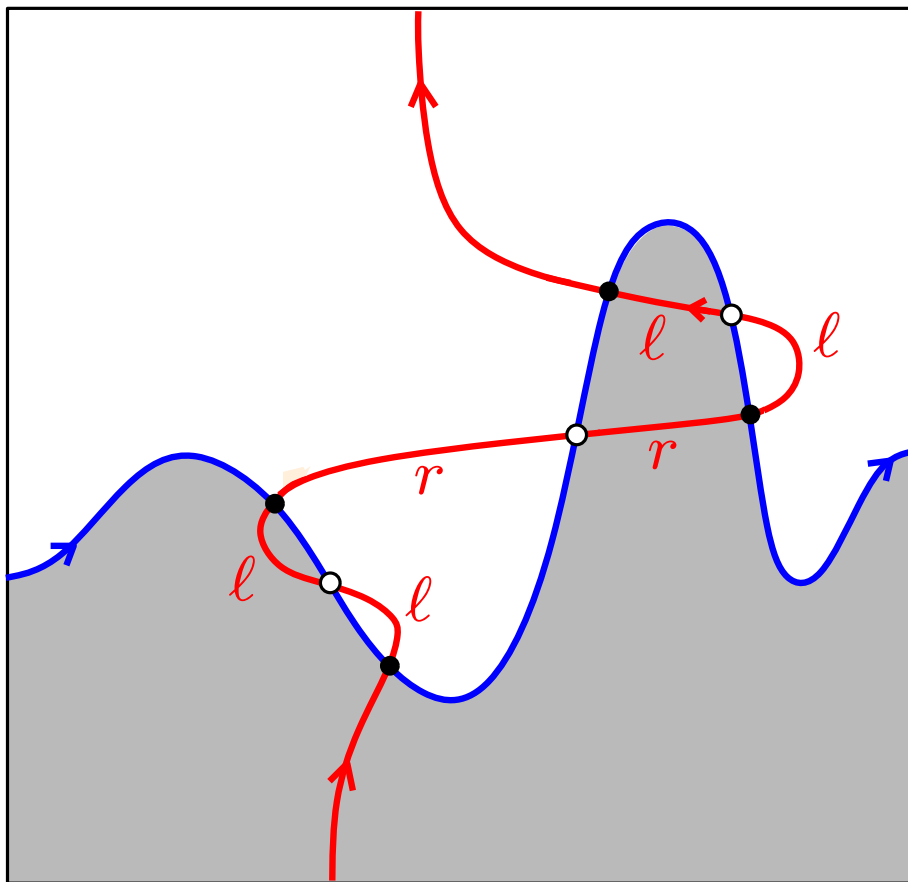

Permutations mapping even to even, odd to odd, and satisfying condition shown on the right are called **complete Baxter permutations**

Theorem ([Boyce'81] reformulated bijectively):

Monotone 2-line meanders with $2n - 1$ crossings are in bijection with **complete Baxter permutations** on $2n - 1$ elements

Inverse construction

From a complete Baxter permutation to a monotone 2-line meander

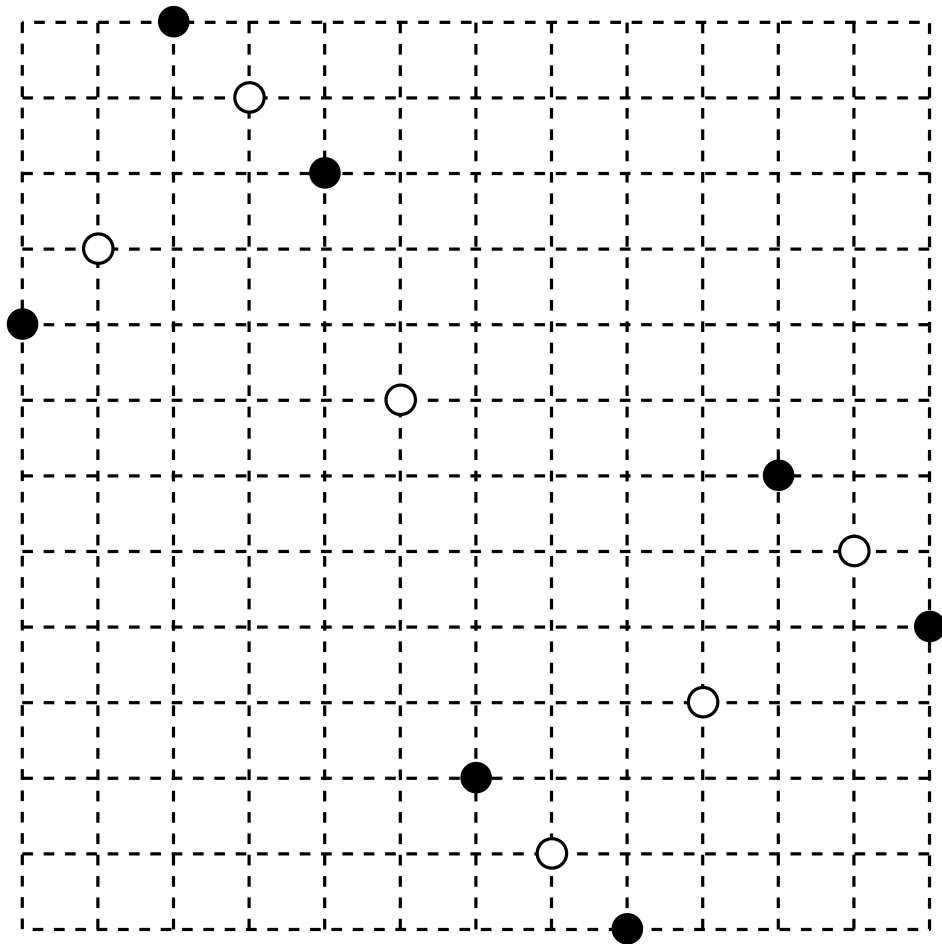

white points are either:

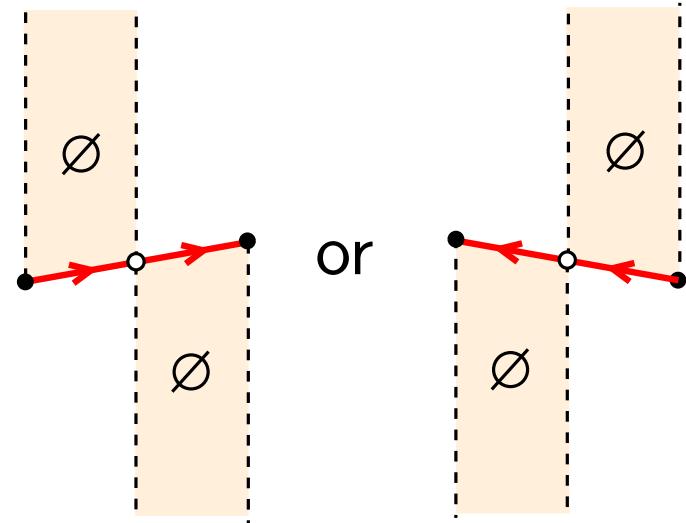

Inverse construction

From a complete Baxter permutation to a monotone 2-line meander

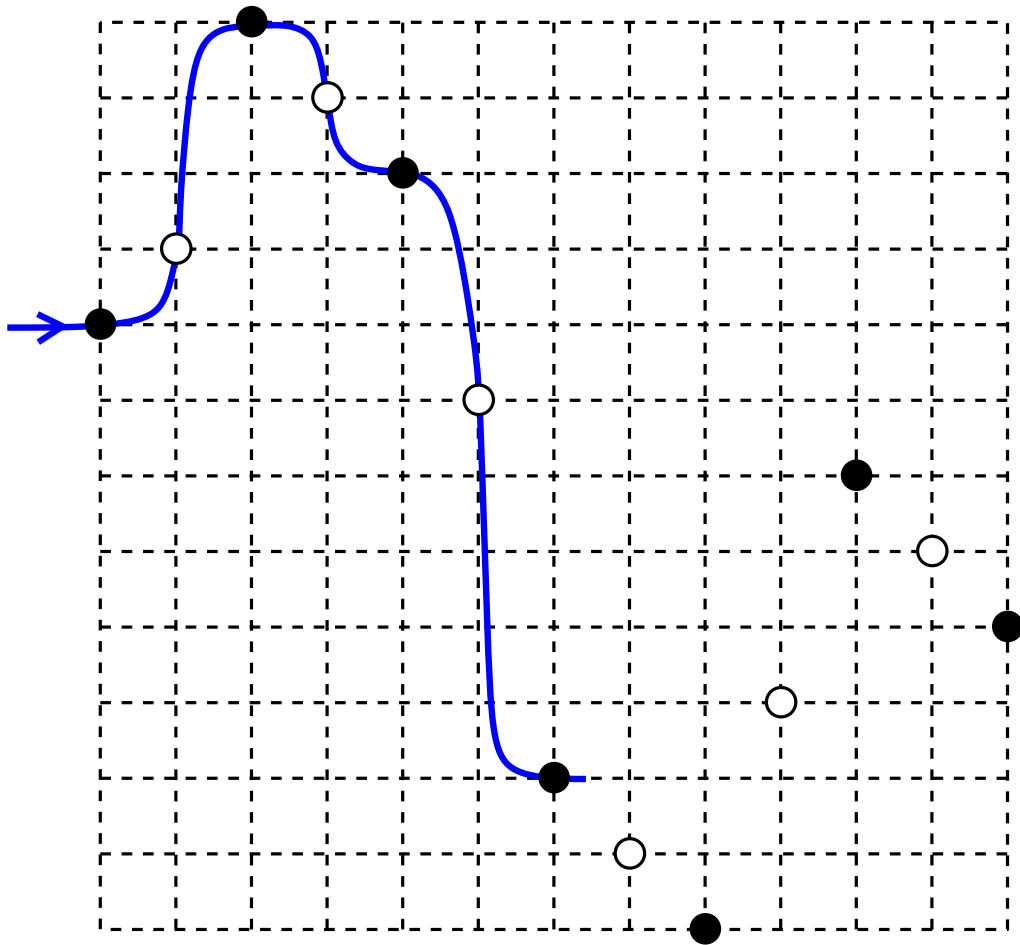

white points are either:

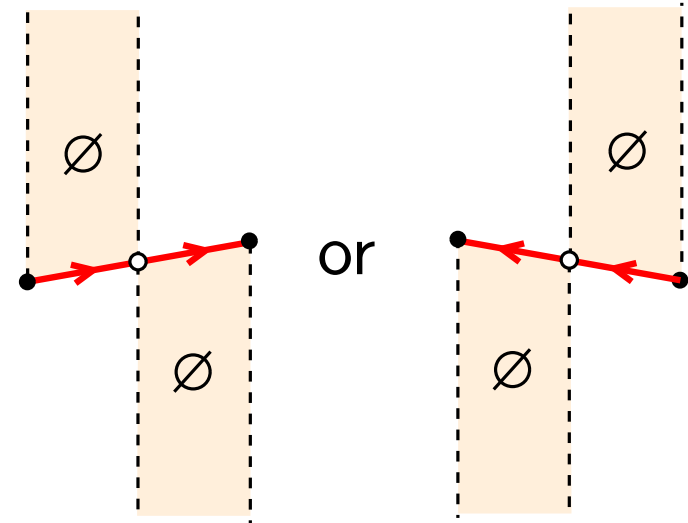

1) Draw the blue curve

Inverse construction

From a complete Baxter permutation to a monotone 2-line meander

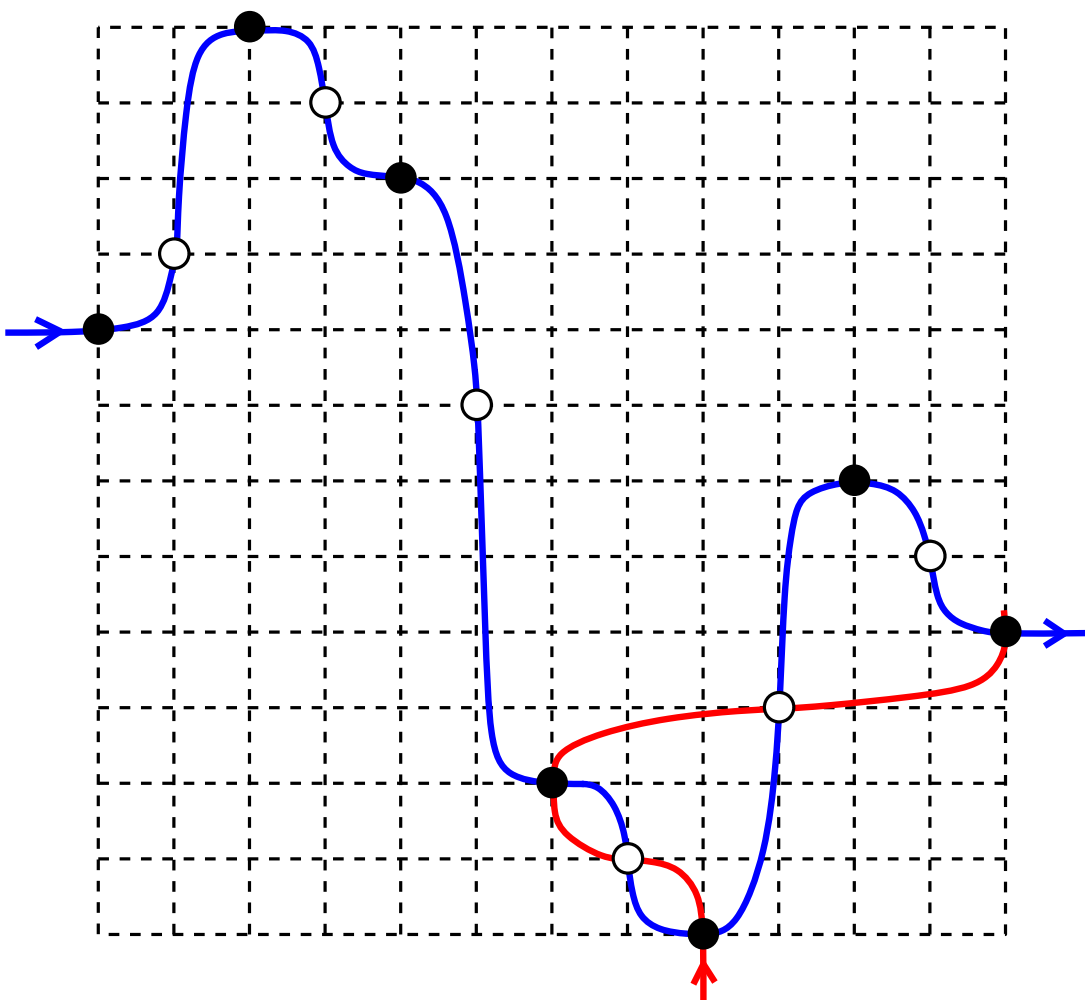

white points are either:

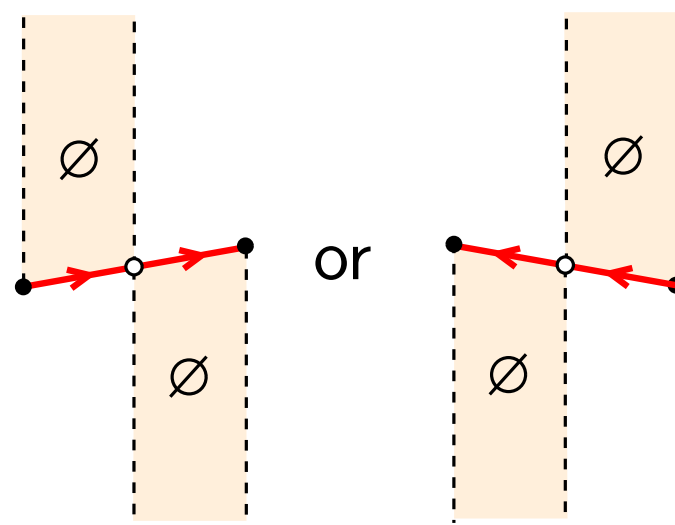

- 1) Draw the blue curve
- 2) Draw the red curve

Inverse construction

From a complete Baxter permutation to a monotone 2-line meander

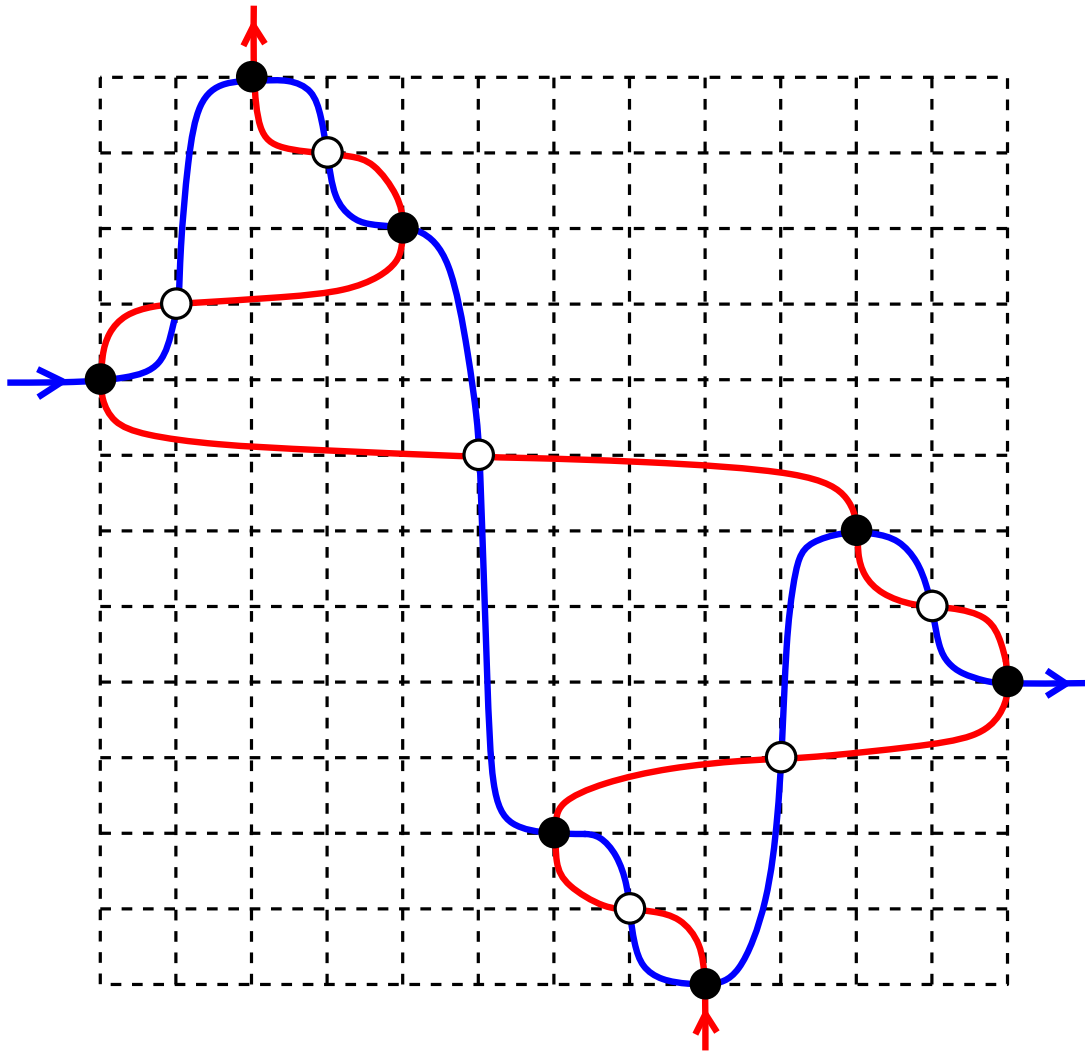

white points are either:

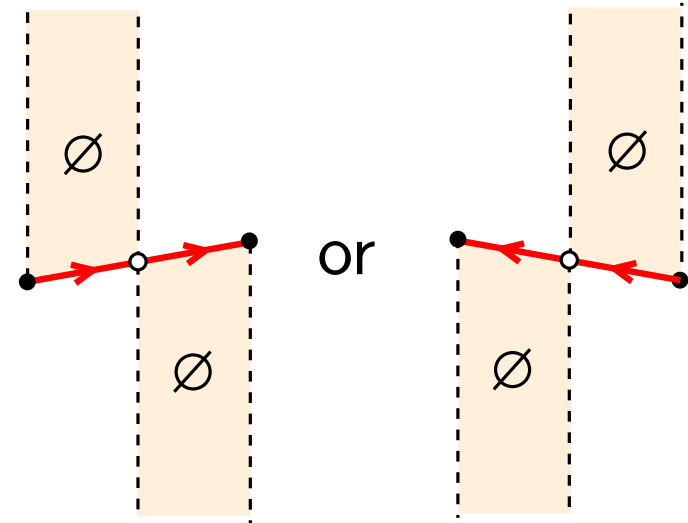

- 1) Draw the blue curve
- 2) Draw the red curve

Inverse construction

From a complete Baxter permutation to a monotone 2-line meander

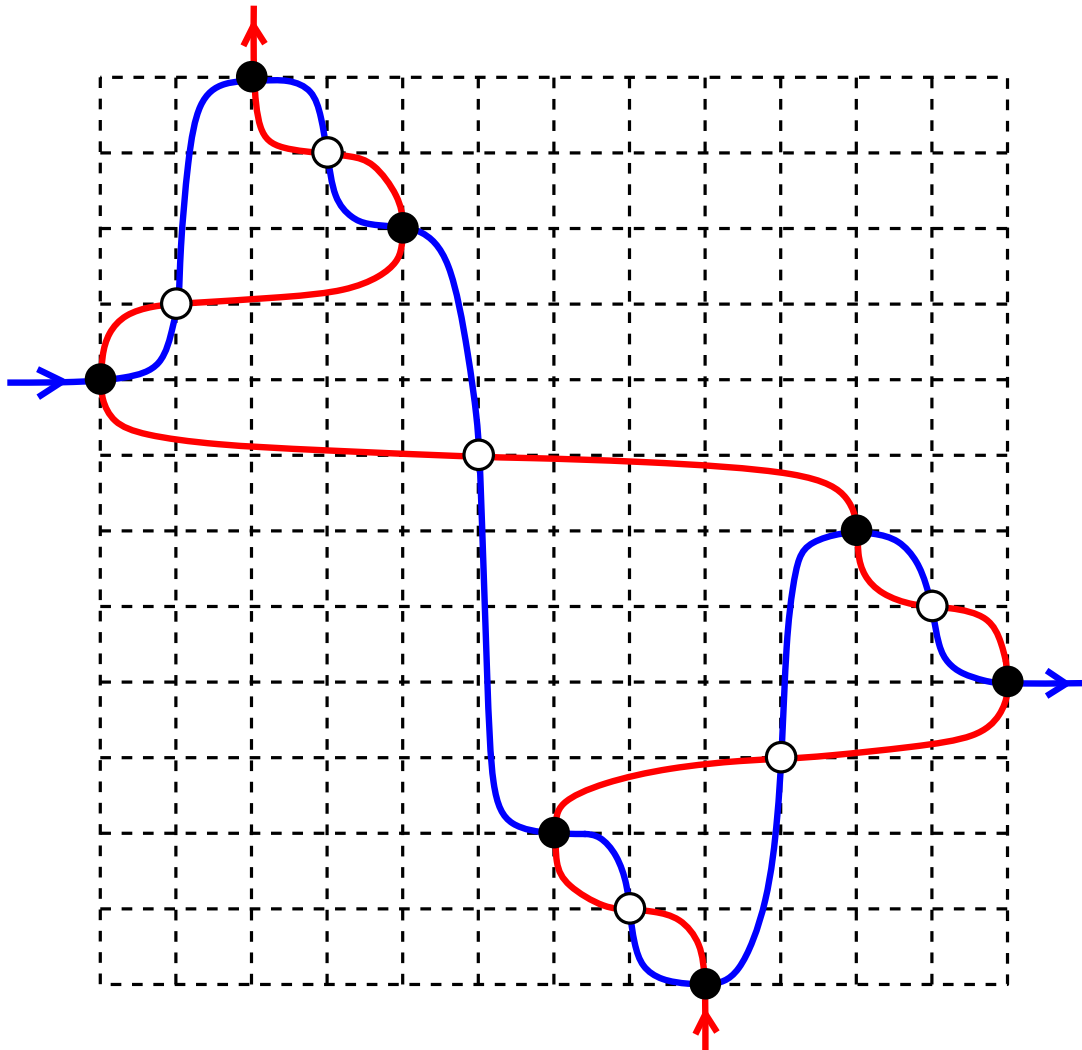

white points are either:

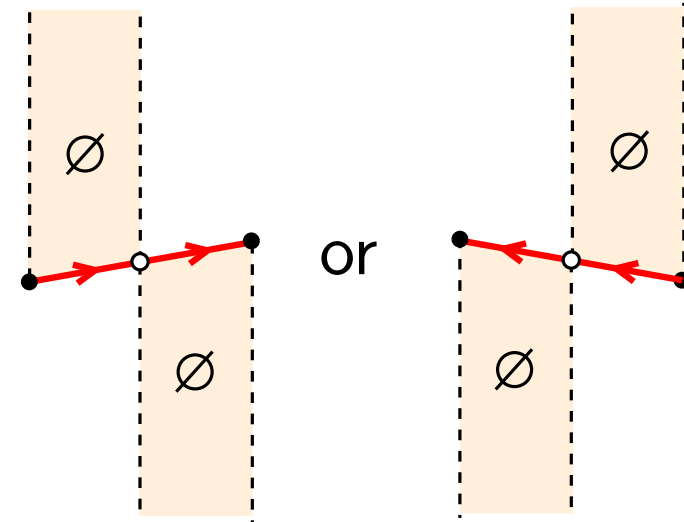

- 1) Draw the blue curve
- 2) Draw the red curve

The two curves meet only at the permutation points
(because of the empty area-property at white points)

Complete and reduced Baxter permutations

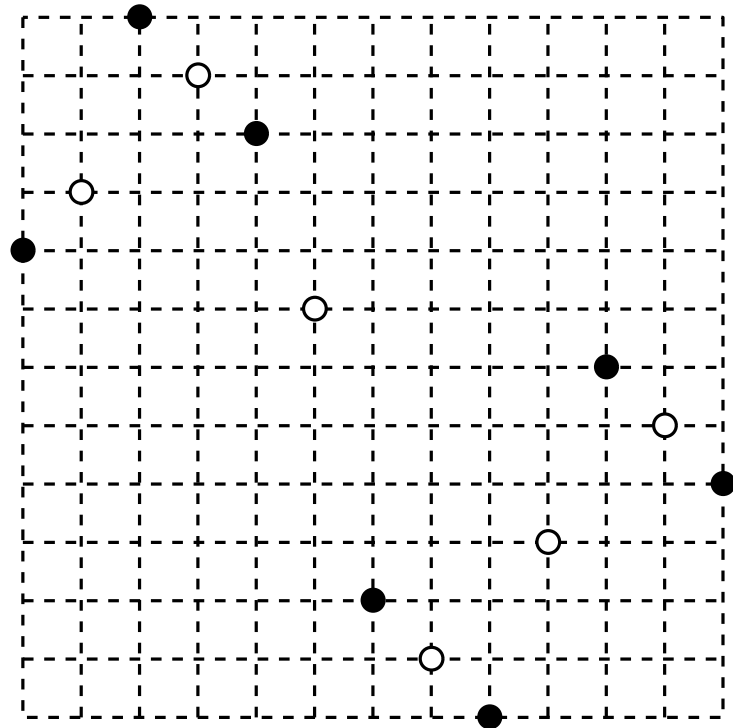

complete

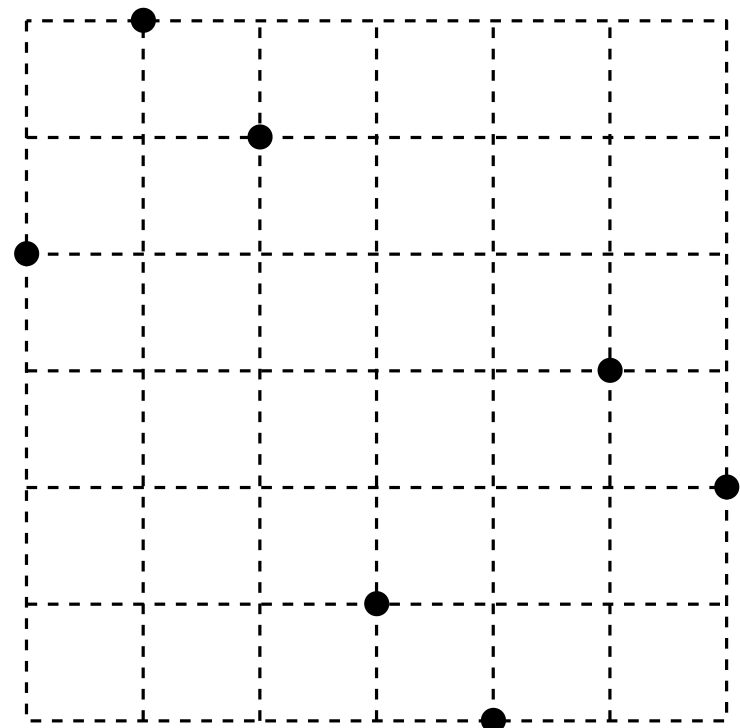

reduced

Complete and reduced Baxter permutations

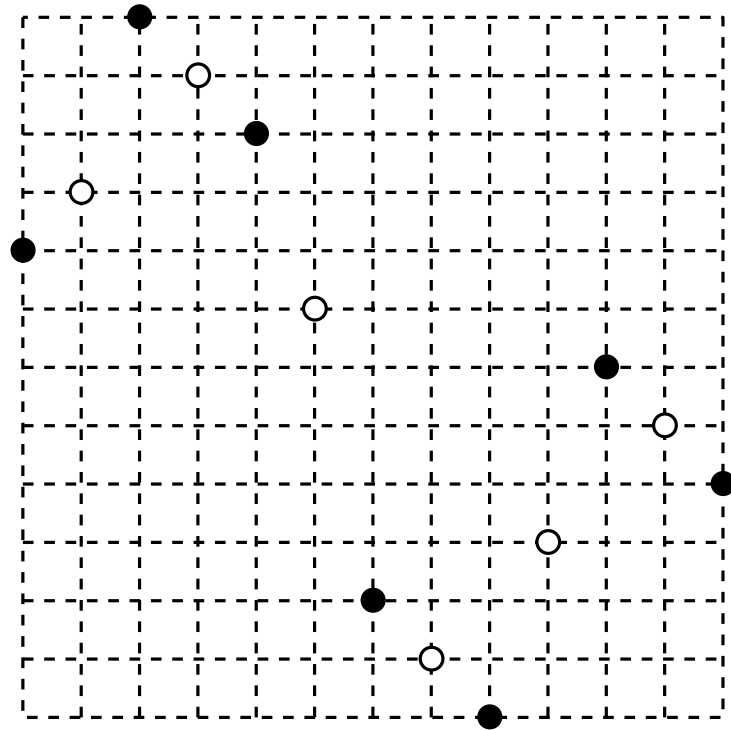

complete

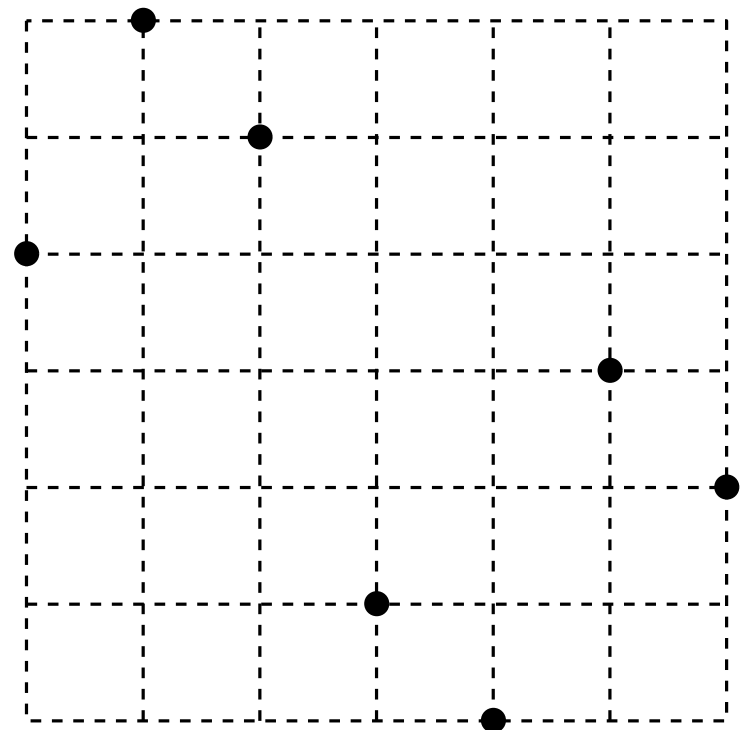

reduced

- complete one can be recovered from reduced one

Complete and reduced Baxter permutations

case of a descent

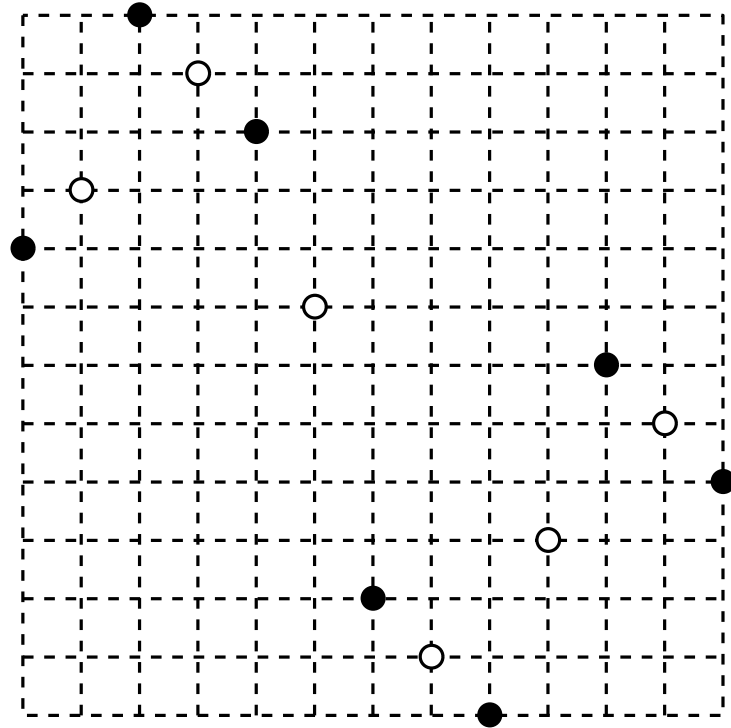

complete

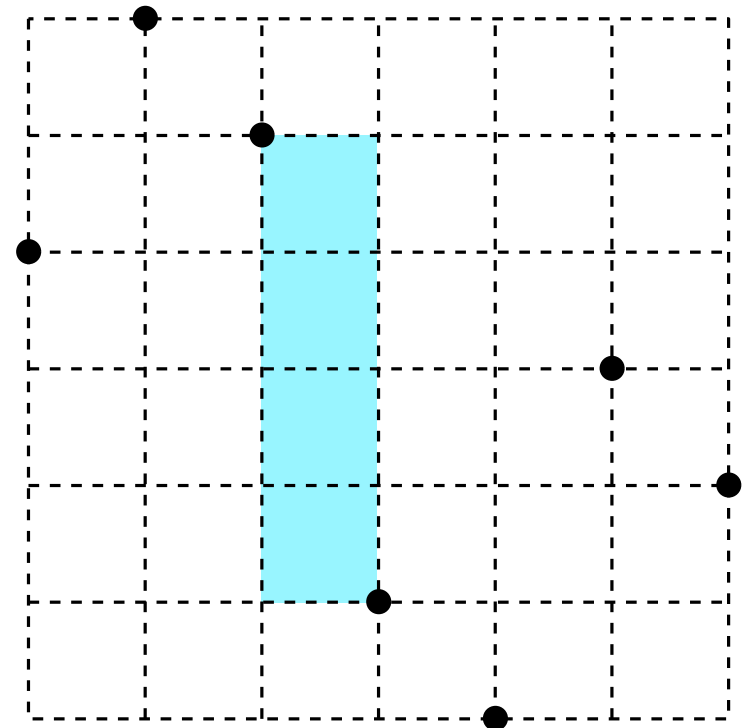

reduced

- complete one can be recovered from reduced one

Complete and reduced Baxter permutations

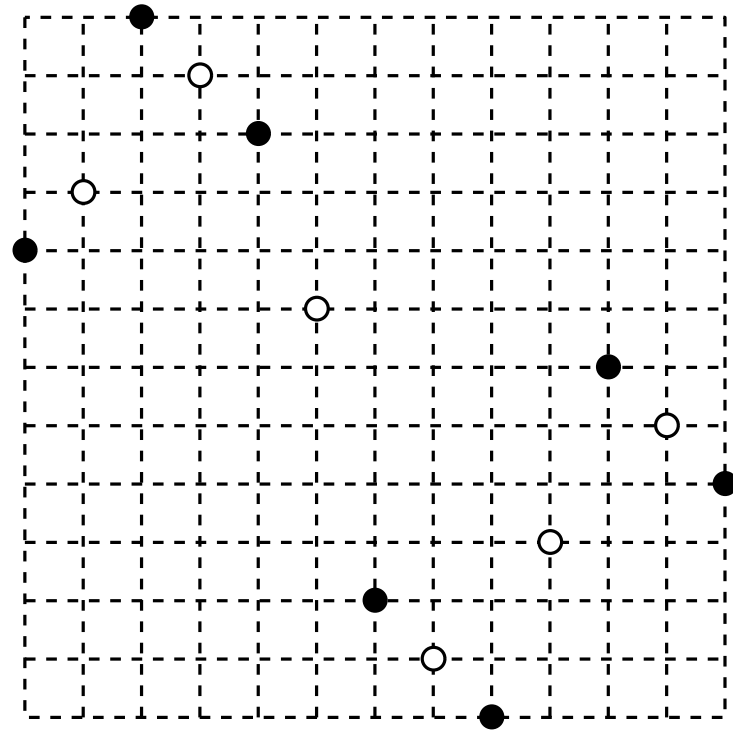

complete



case of a descent

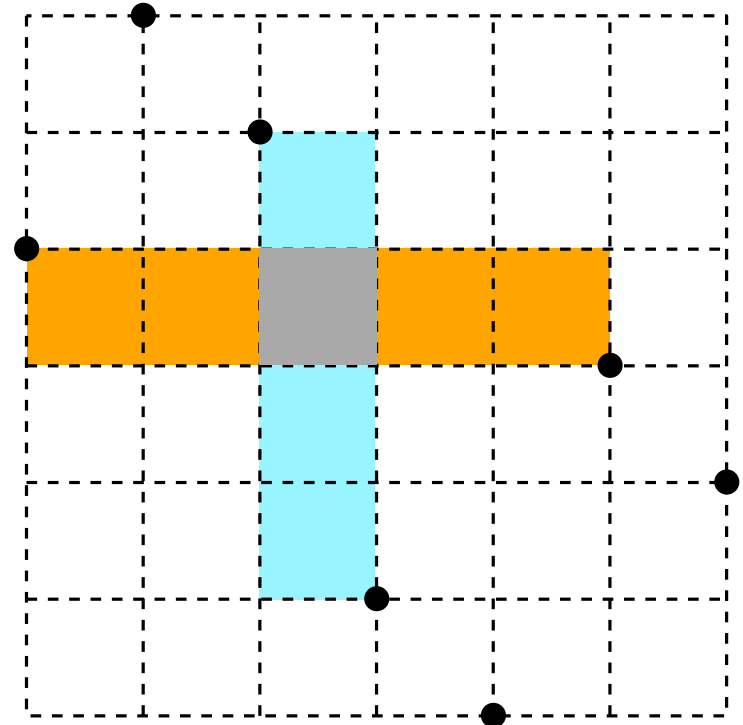

reduced

- complete one can be recovered from reduced one

Complete and reduced Baxter permutations

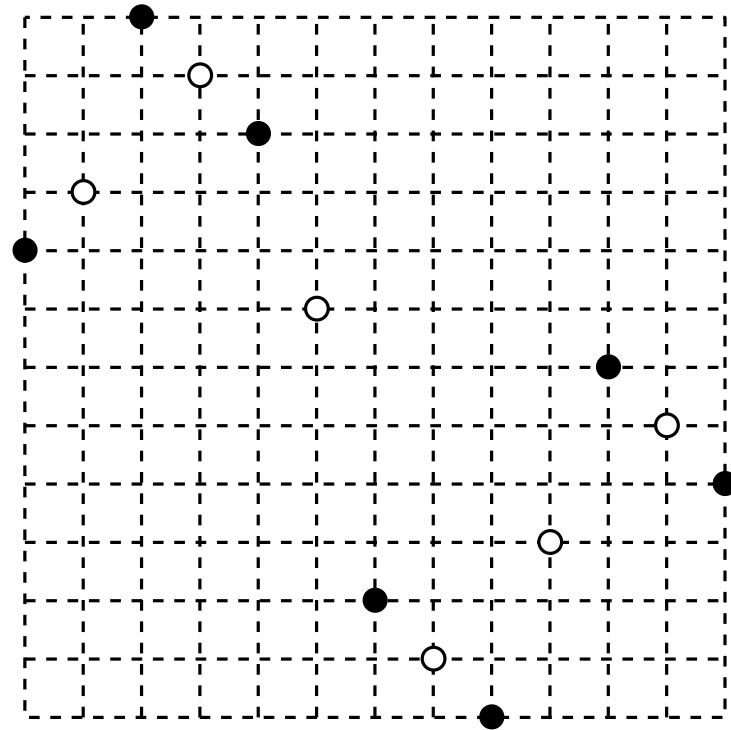

complete



case of a descent

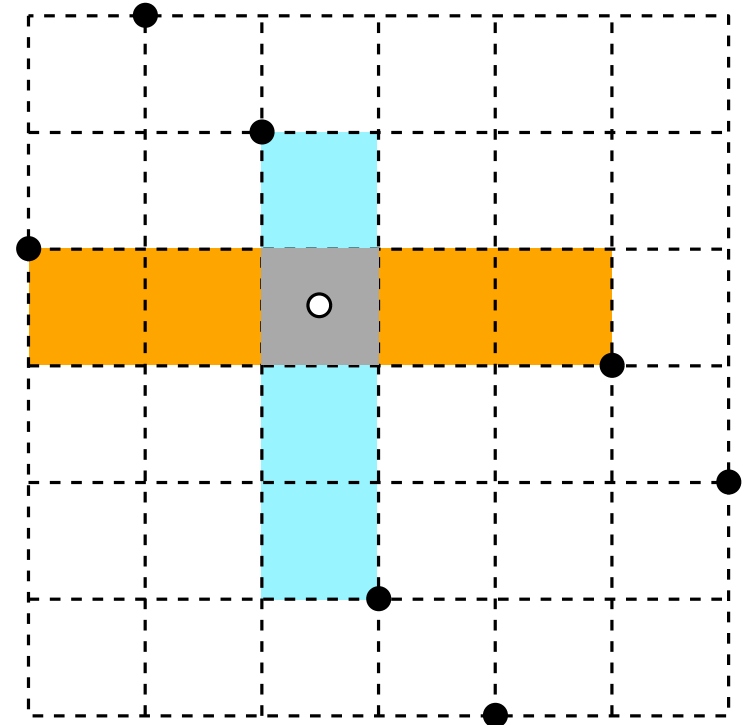

reduced

- complete one can be recovered from reduced one

Complete and reduced Baxter permutations

case of a rise

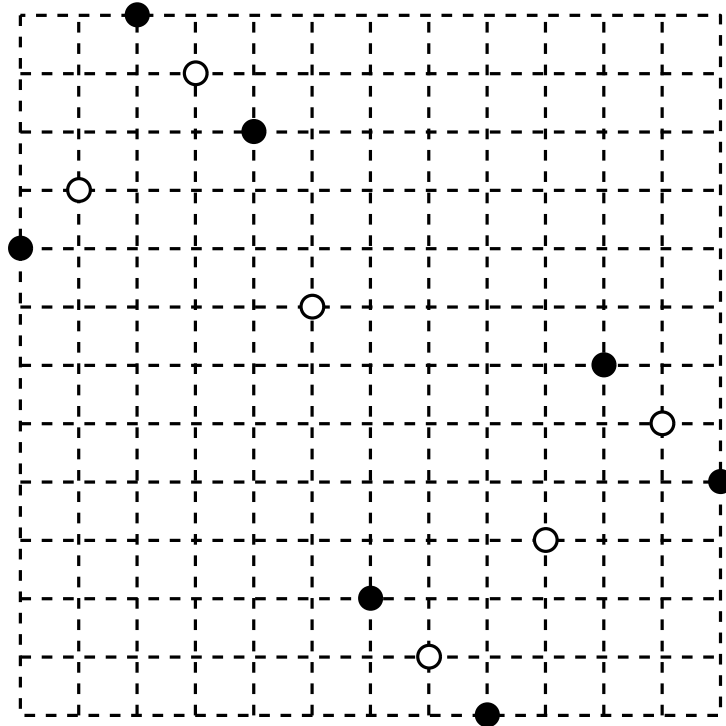

complete

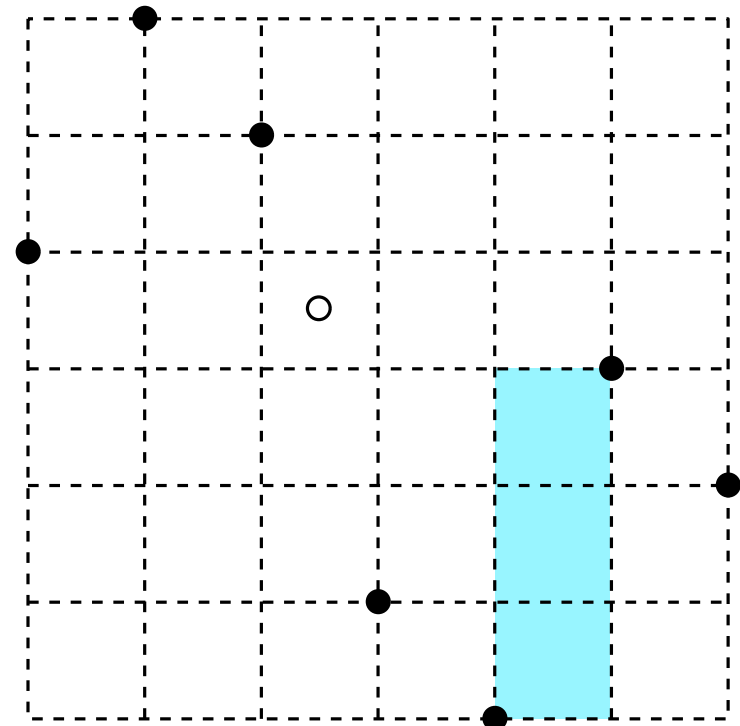

reduced

- complete one can be recovered from reduced one

Complete and reduced Baxter permutations

case of a rise

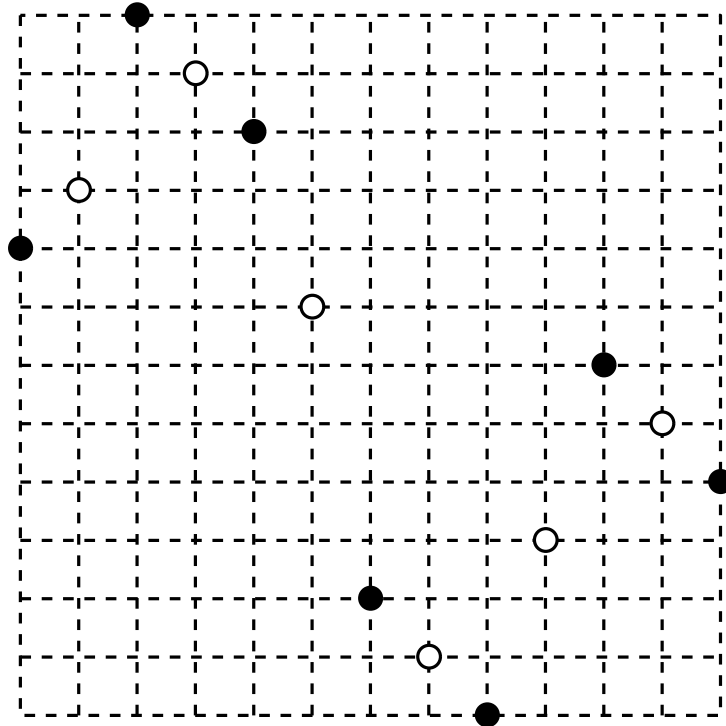

complete

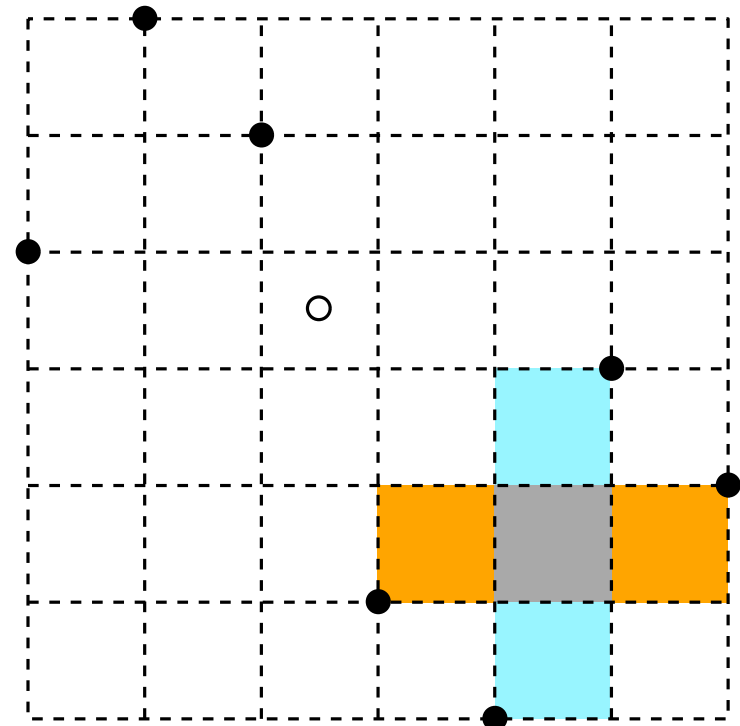

reduced

- complete one can be recovered from reduced one

Complete and reduced Baxter permutations

case of a rise

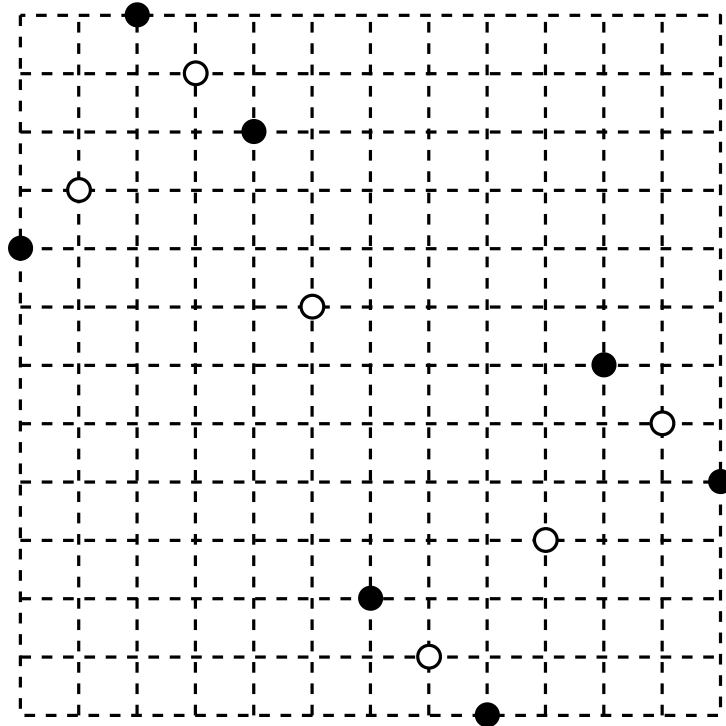

complete

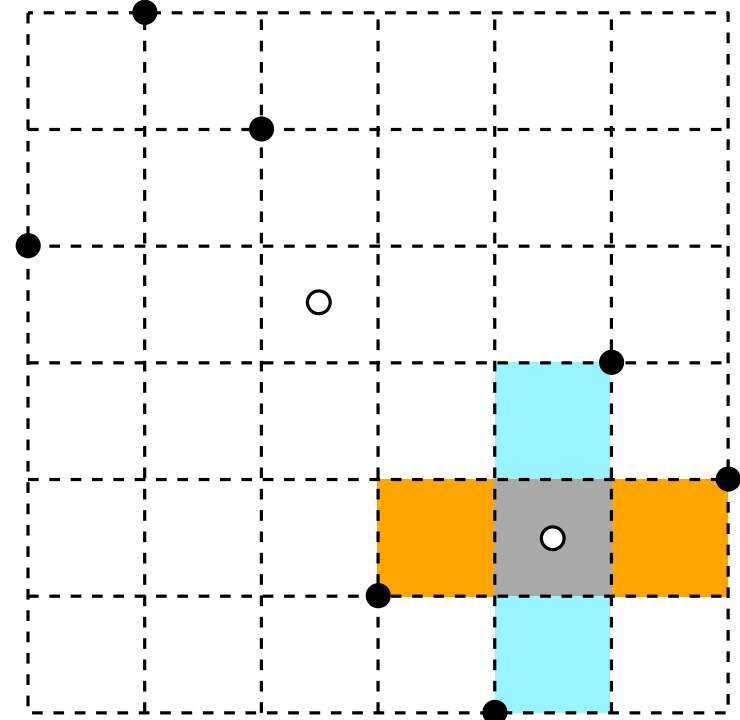

reduced

- complete one can be recovered from reduced one

Complete and reduced Baxter permutations

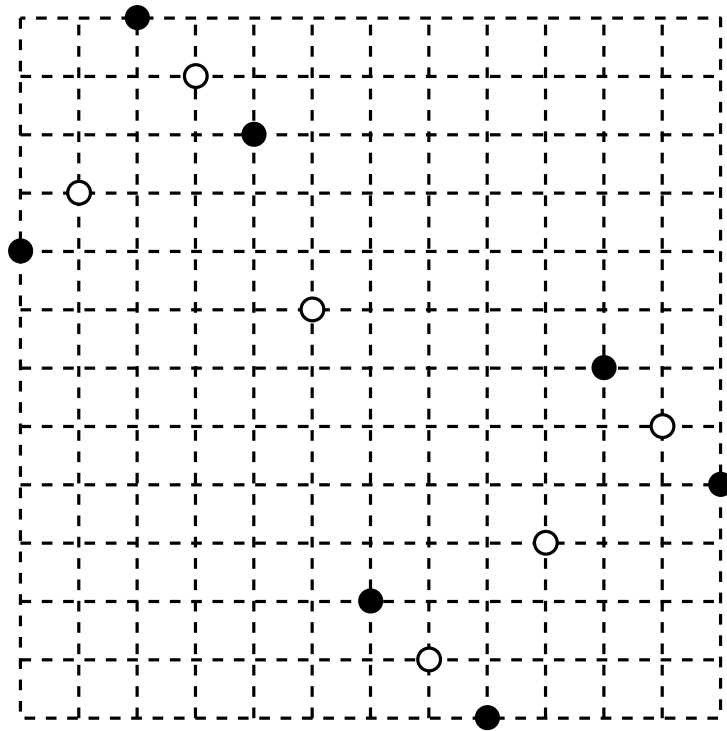

complete

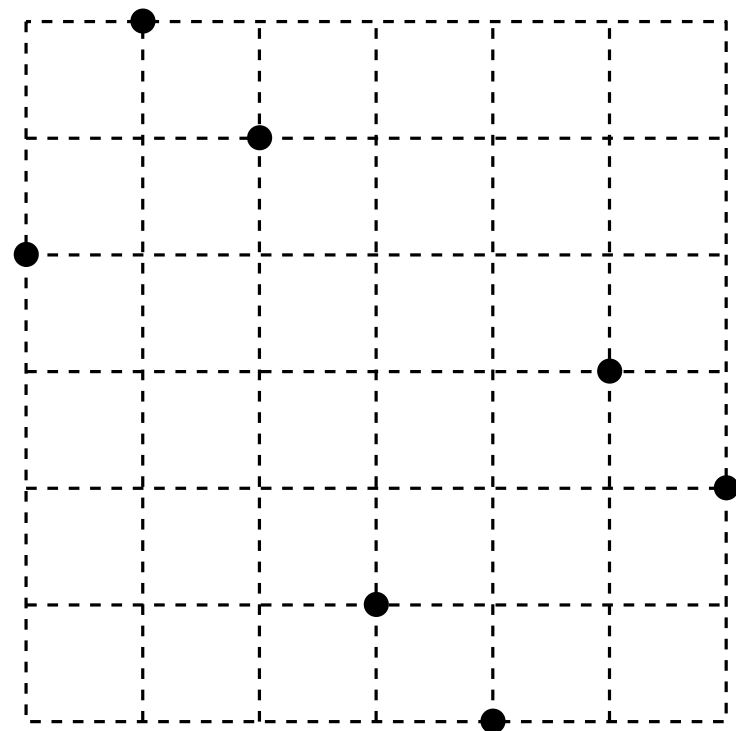

reduced

- complete one can be recovered from reduced one
- reduced one is characterized by forbidden patterns
 $2 - 41 - 3$ and $3 - 14 - 2$

Complete and reduced Baxter permutations

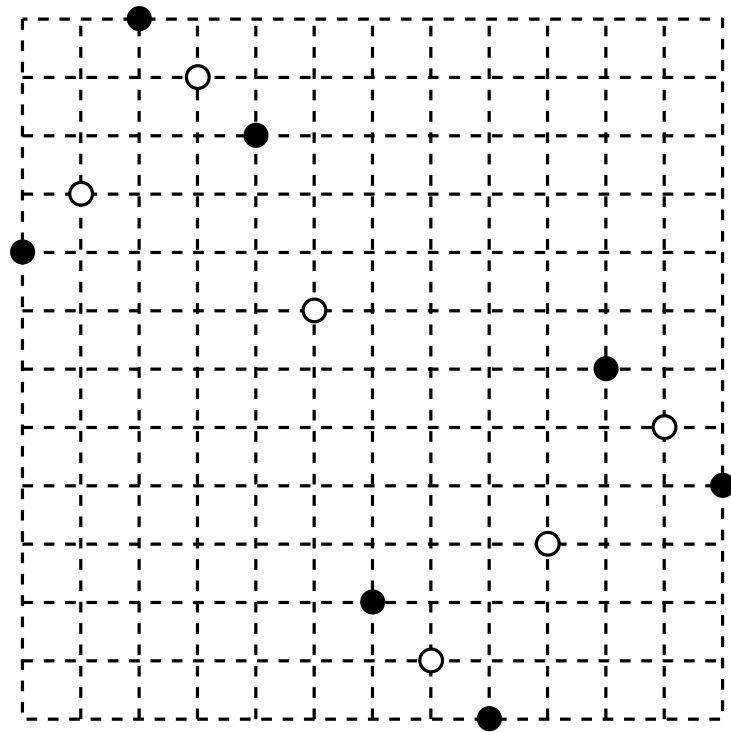

complete

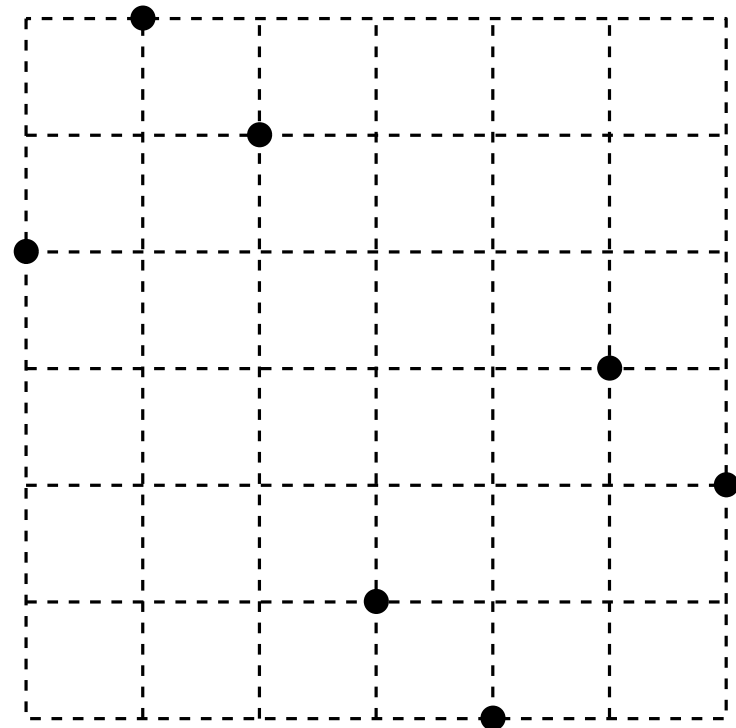

reduced

- complete one can be recovered from reduced one
- reduced one is characterized by forbidden patterns
 $2 - 41 - 3$ and $3 - 14 - 2$
- permutation on white points (called anti-Baxter)
is characterized by forbidden patterns
 $2 - 14 - 3$ and $3 - 41 - 2$

Counting results

- Baxter permutations

- Number of reduced Baxter permutations with n elements

$$b_n = \sum_{r=0}^{n-1} \frac{2}{n(n+1)^2} \binom{n+1}{r} \binom{n+1}{r+1} \binom{n+1}{r+2}$$

[Chung et al'78] [Mallows'79]

Counting results

- Baxter permutations

- Number of reduced Baxter permutations with n elements

$$b_n = \sum_{r=0}^{n-1} \frac{2}{n(n+1)^2} \binom{n+1}{r} \binom{n+1}{r+1} \binom{n+1}{r+2}$$

[Chung et al'78] [Mallows'79]

- Bijective proof: **[Viennot'81], [Dulucq-Guibert'98]**

5 7 6 2 1 4 3

\Leftrightarrow

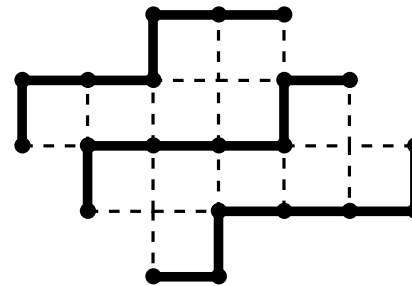

Counting results

- Baxter permutations

- Number of reduced Baxter permutations with n elements

$$b_n = \sum_{r=0}^{n-1} \frac{2}{n(n+1)^2} \binom{n+1}{r} \binom{n+1}{r+1} \binom{n+1}{r+2}$$

[Chung et al'78] [Mallows'79]

- Bijective proof: [Viennot'81], [Dulucq-Guibert'98]

5 7 6 2 1 4 3

\Leftrightarrow

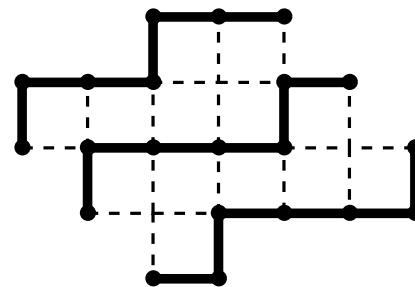

- Subfamilies

- alternating [Cori-Dulucq-Viennot'86], [Dulucq-Guibert'98]

$$\text{Cat}_k \text{Cat}_k \text{ if } n = 2k$$

$$\text{Cat}_k \text{Cat}_{k+1} \text{ if } n = 2k + 1$$

- doubly alternating [Guibert-Linusson'00]

$$\text{Cat}_k \text{ where } k = \lfloor n/2 \rfloor$$

- anti-Baxter permutations

[Asinowski et al'10]

$$a_n = \sum_{i=0}^{\lfloor (n+1)/2 \rfloor} (-1)^i \binom{n+1-i}{i} b_{n+1-i}$$

Local conditions for monotone 2-line meanders

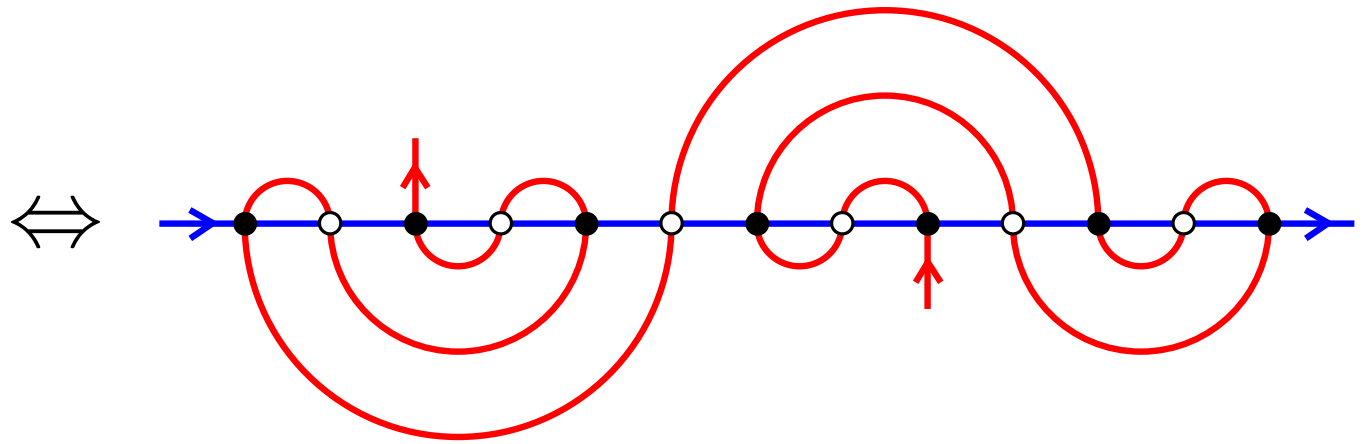
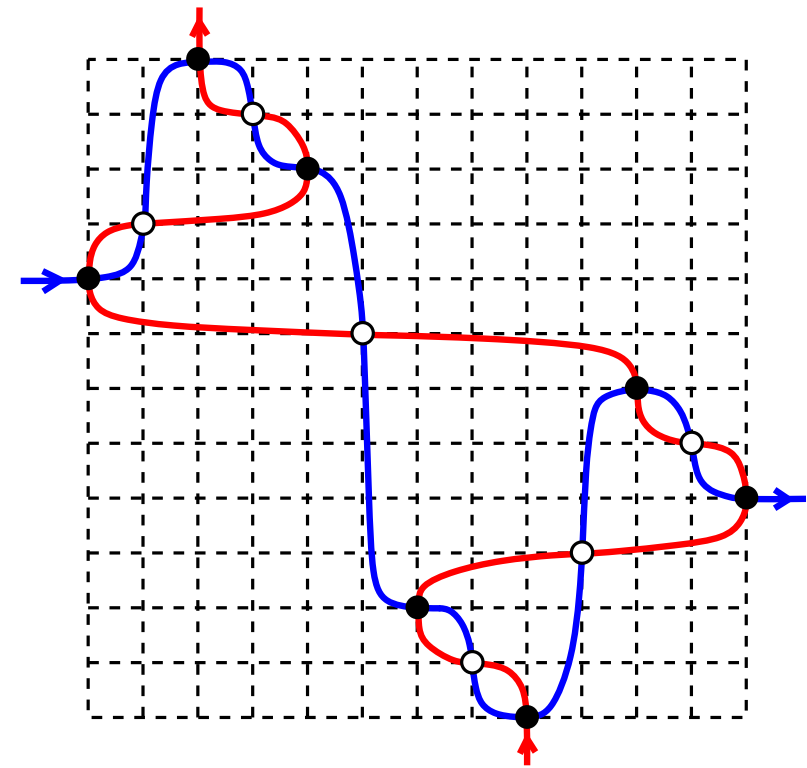

Conditions

- two bipartite matchings missing a black point (one above, one below the blue line)

- white points are either

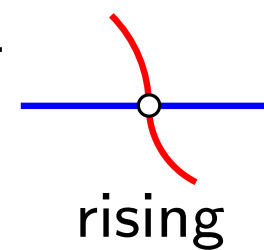

rising

or

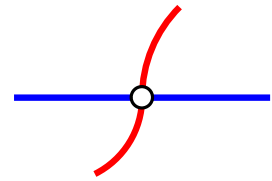

descending

Local conditions for monotone 2-line meanders

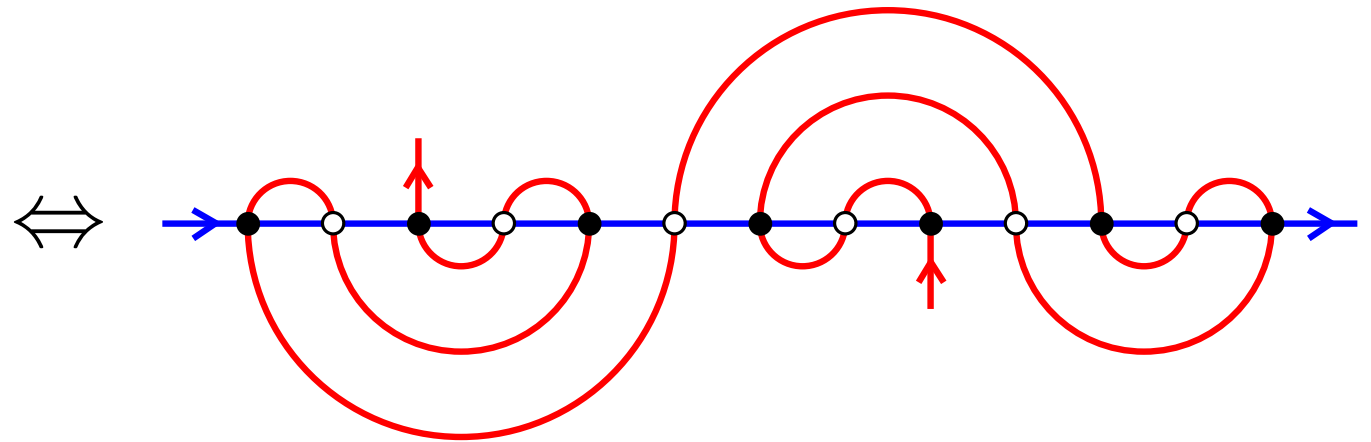
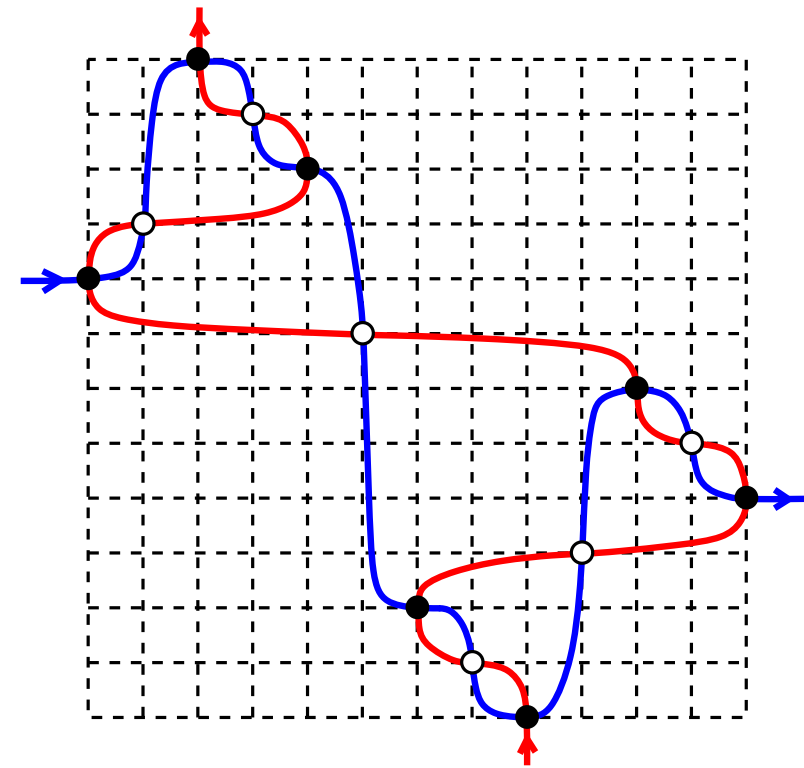

Conditions

- two bipartite matchings missing a black point (one above, one below the blue line)
- white points are either

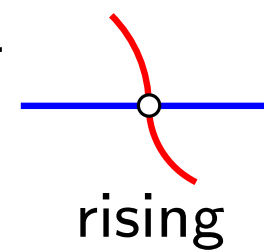

or

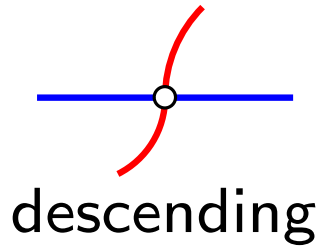

Proof of \Leftarrow

Assume there is a red loop (say, clockwise):

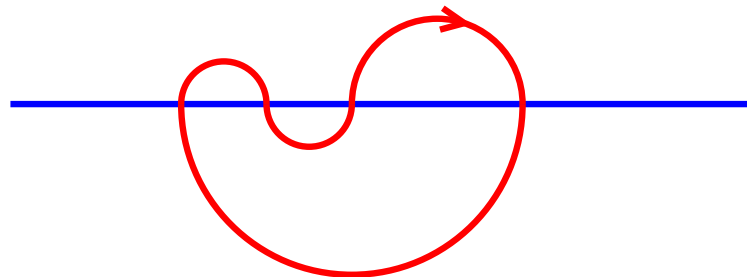

Local conditions for monotone 2-line meanders

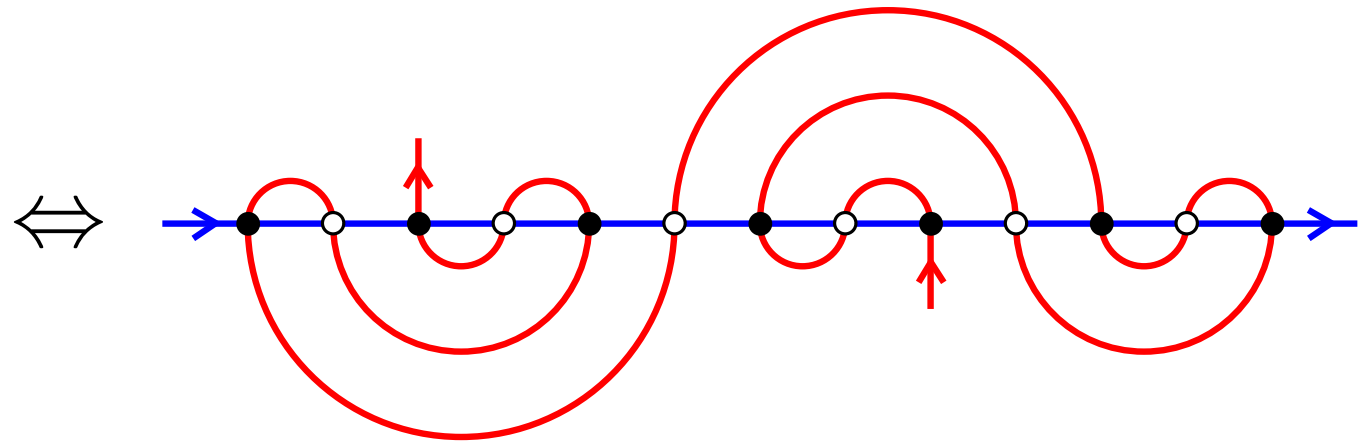
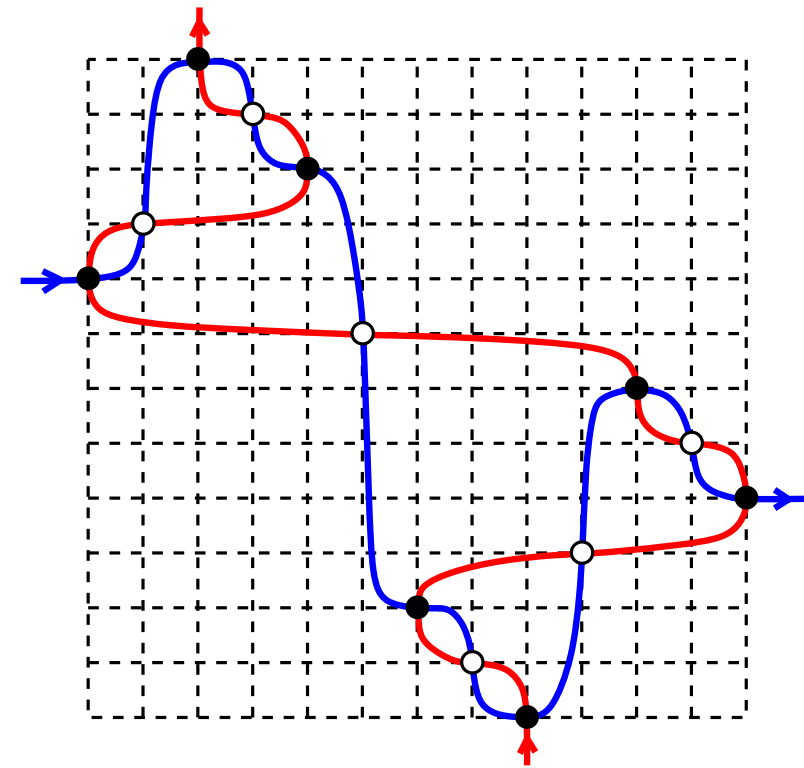

Conditions

- two bipartite matchings missing a black point (one above, one below the blue line)
- white points are either

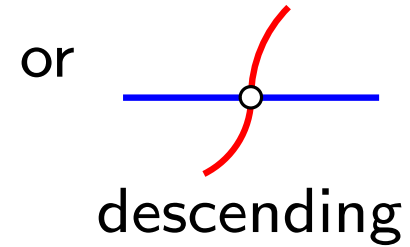
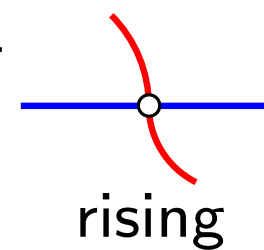

Proof of \Leftarrow

Assume there is a red loop (say, clockwise):

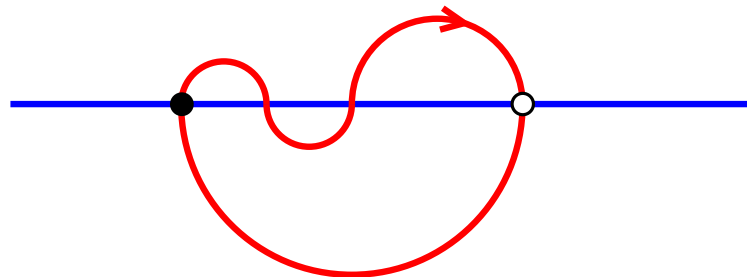

then the leftmost and the rightmost point on the loop are of different colors

Local conditions for monotone 2-line meanders

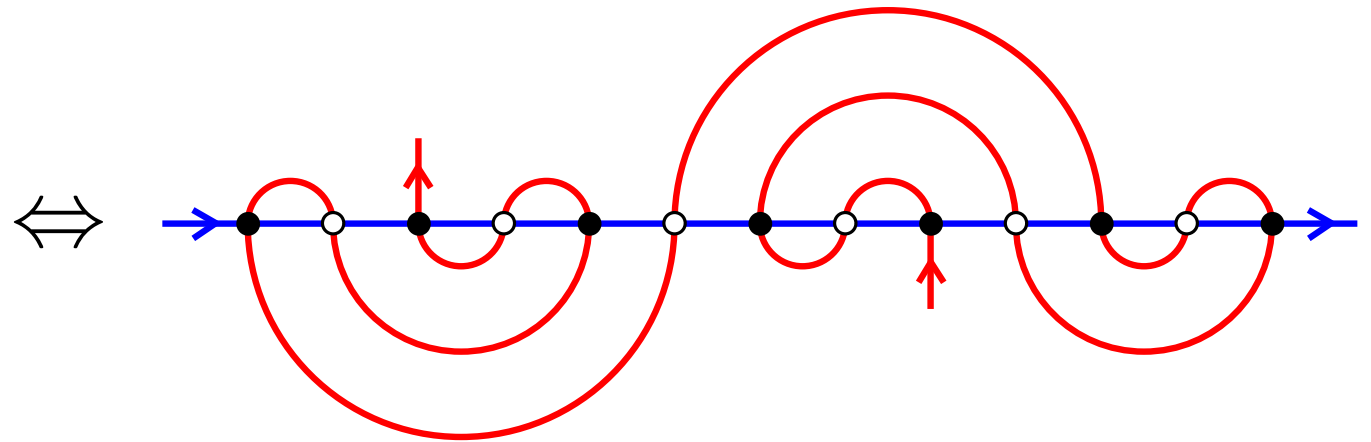
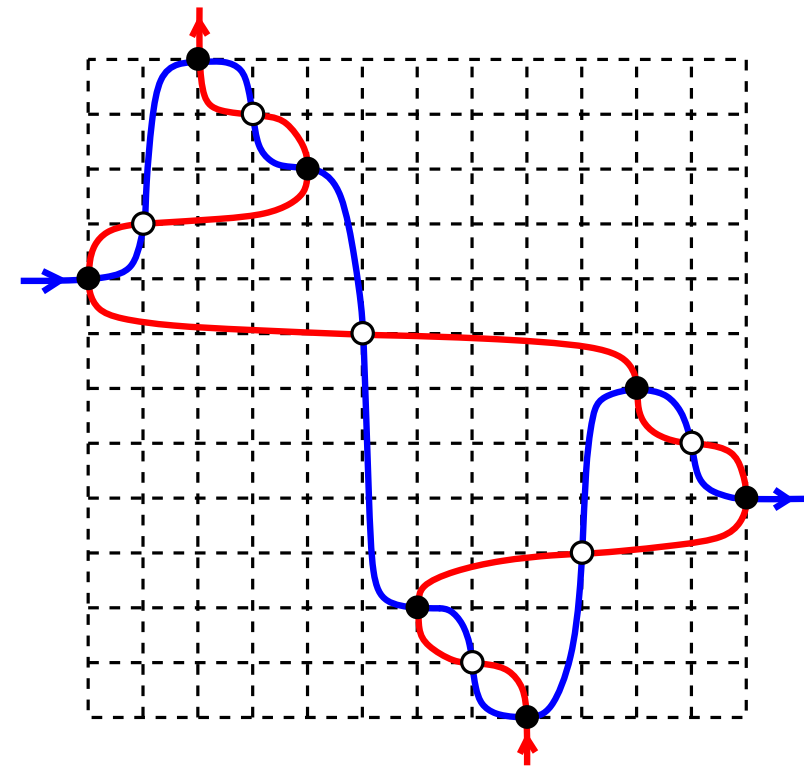

Conditions

- two bipartite matchings missing a black point (one above, one below the blue line)

- white points are either

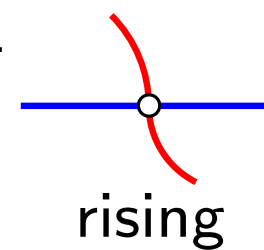

or

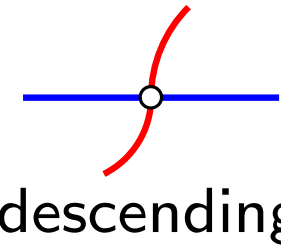

Proof of \Leftarrow

Assume there is a red loop (say, clockwise):

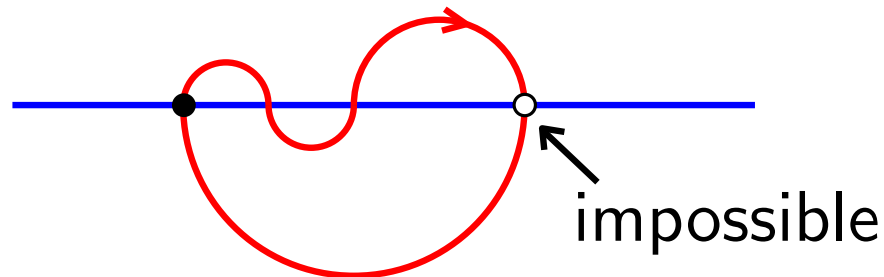

then the leftmost and the rightmost point on the loop are of different colors

Local conditions for monotone 2-line meanders

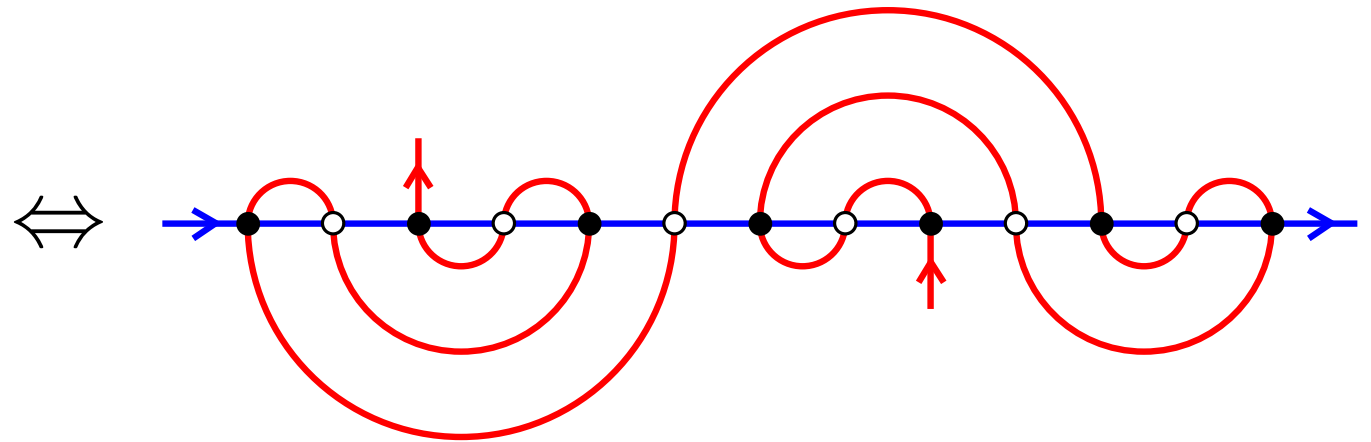
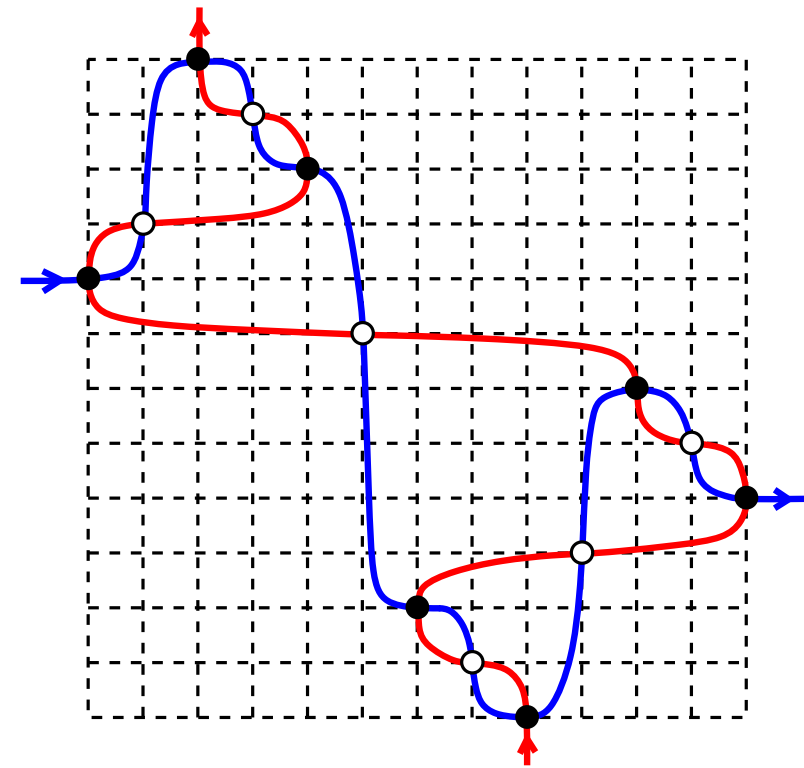

Conditions

- two bipartite matchings missing a black point (one above, one below the blue line)

- white points are either

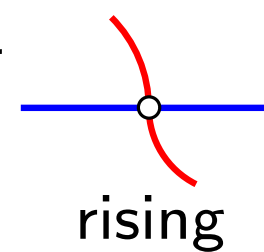

or

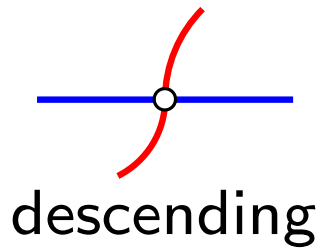

Proof of \Leftarrow

Assume there is a red loop (say, clockwise):

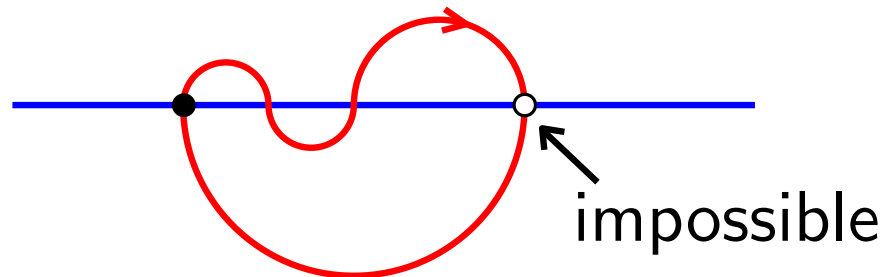

then the leftmost and the rightmost point on the loop are of different colors

\Rightarrow we have a 2-line meander

Local conditions for monotone 2-line meanders

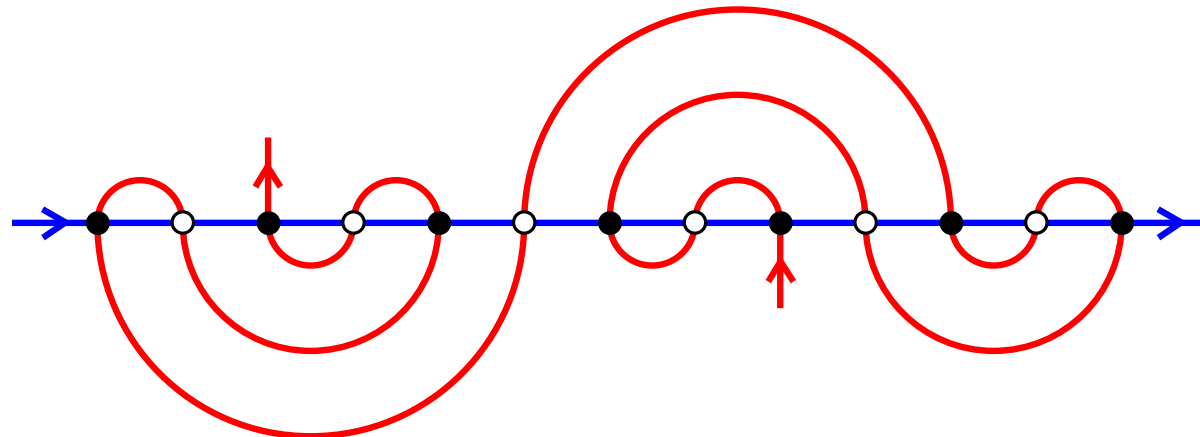
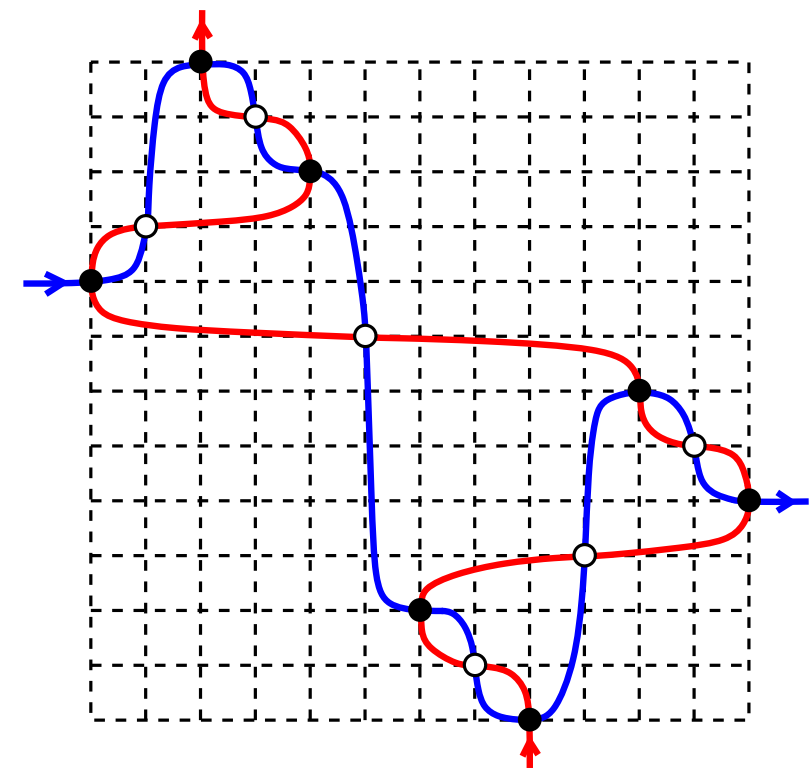

Conditions

- two bipartite matchings missing a black node (one above, one below the blue line)

- white nodes are either

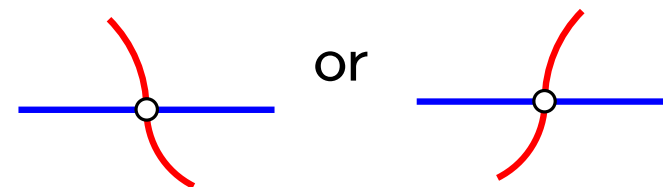

Proof of \Leftarrow : construct permutation step by step

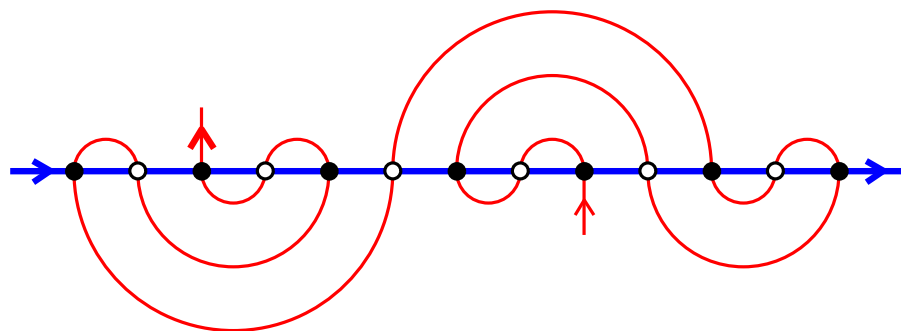

Local conditions for monotone 2-line meanders

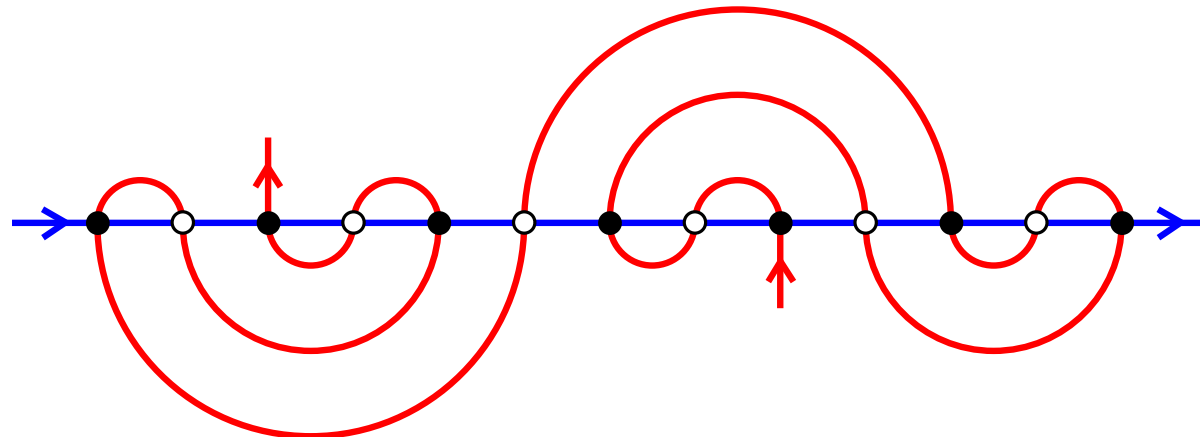
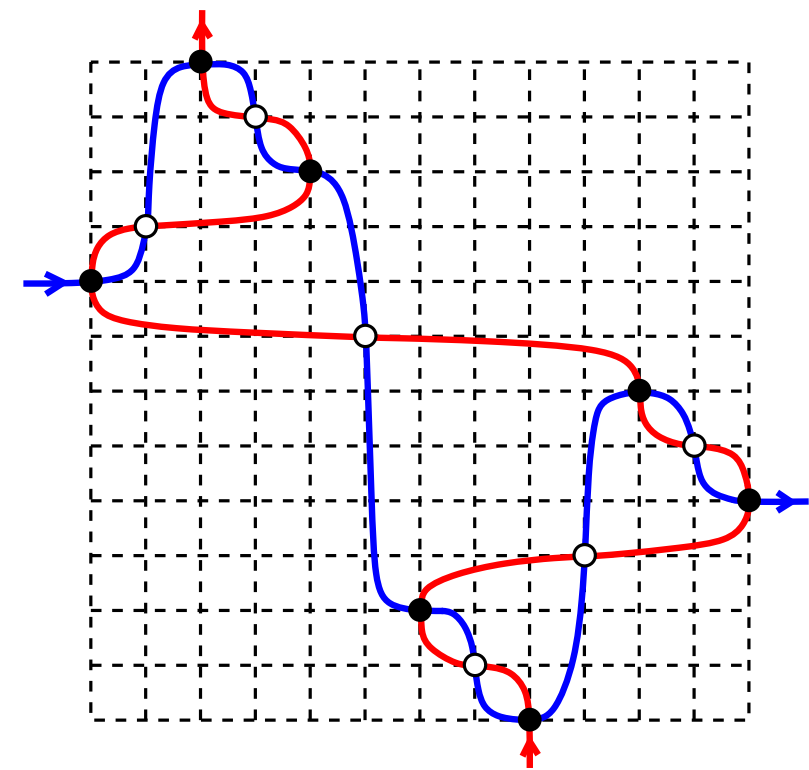

Conditions

- two bipartite matchings missing a black node (one above, one below the blue line)

- white nodes are either

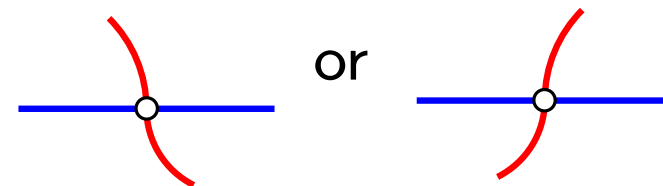

Proof of \Leftarrow : construct permutation step by step

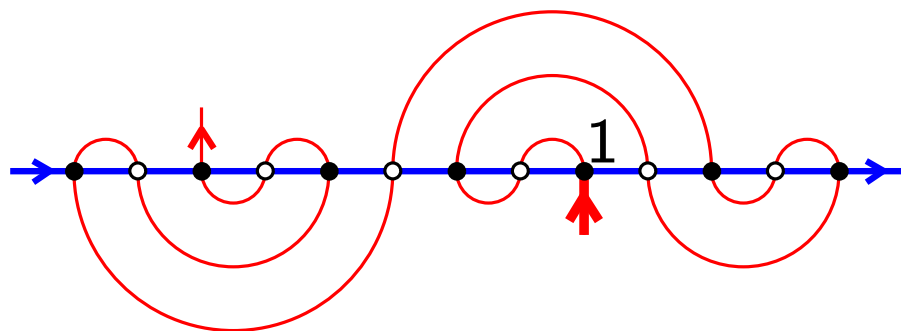

Local conditions for monotone 2-line meanders

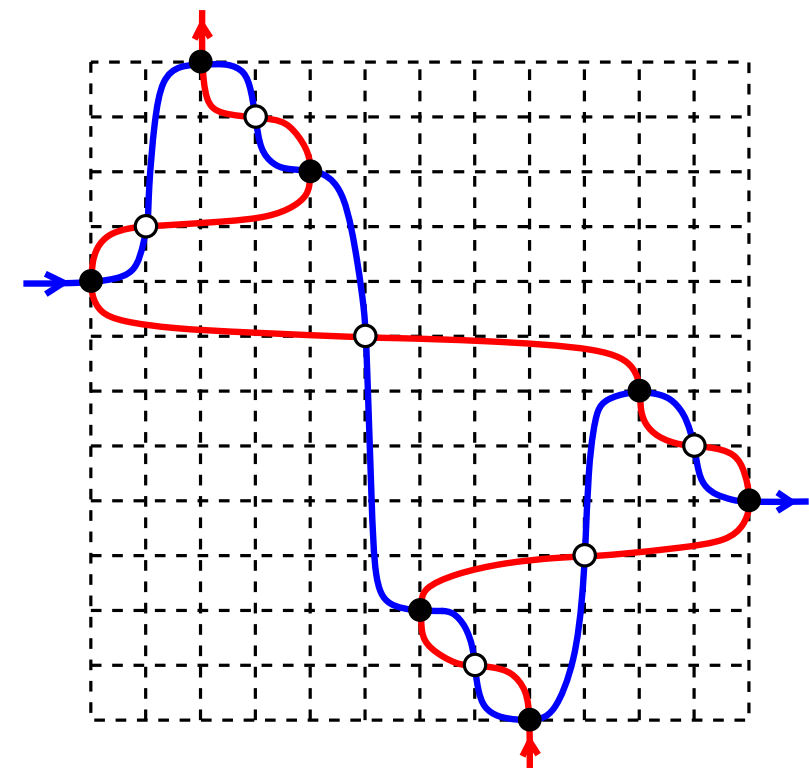

\Leftrightarrow

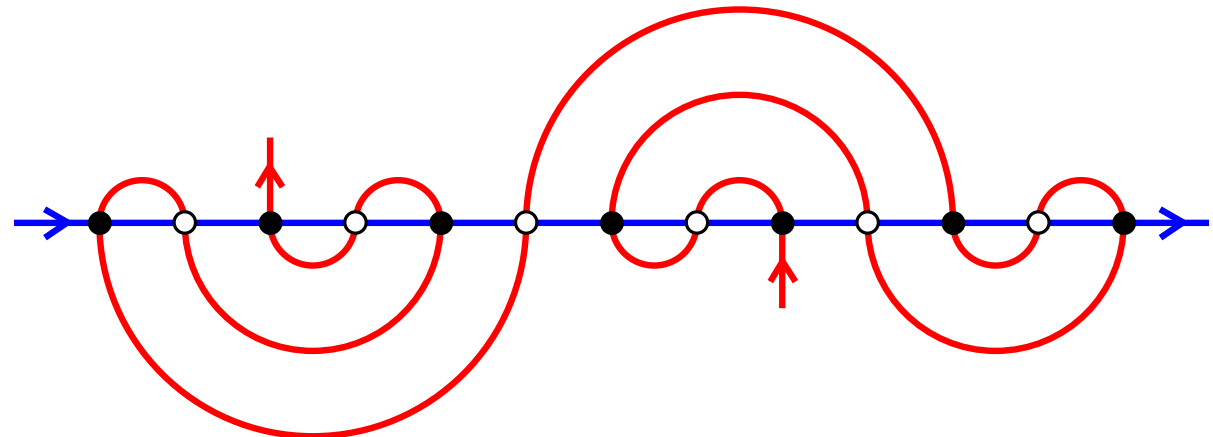

Conditions

- two bipartite matchings missing a black node (one above, one below the blue line)
- white nodes are either

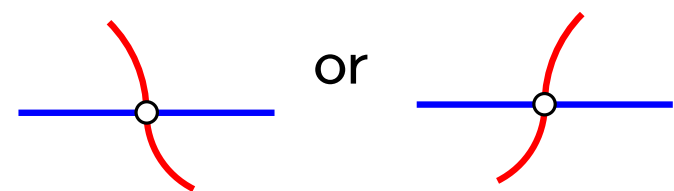

Proof of \Leftarrow : construct permutation step by step

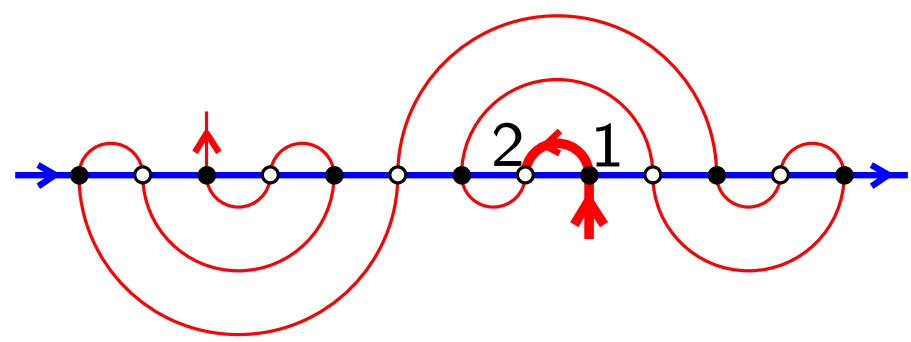

Local conditions for monotone 2-line meanders

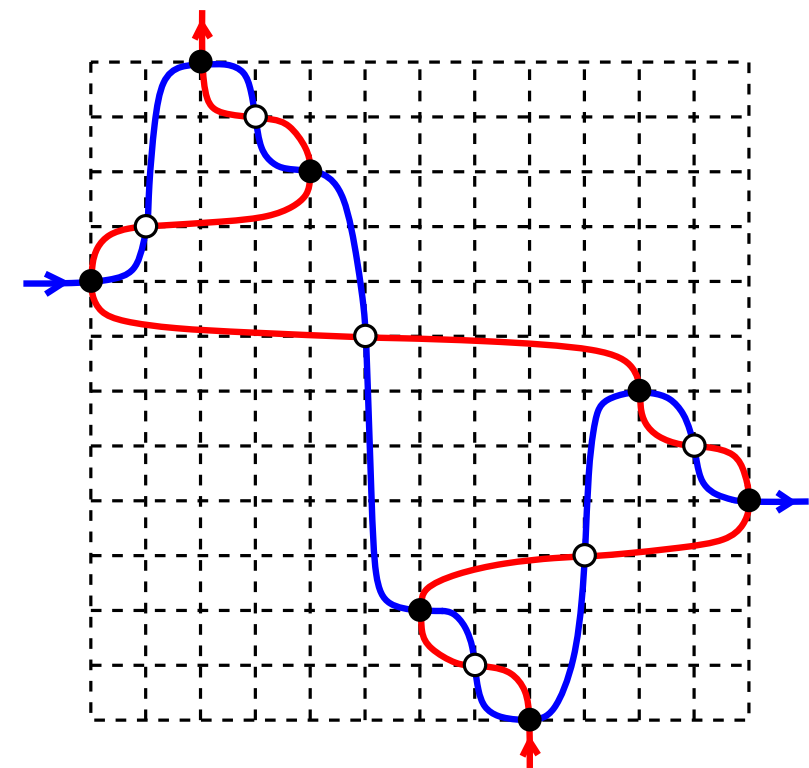

\Leftrightarrow

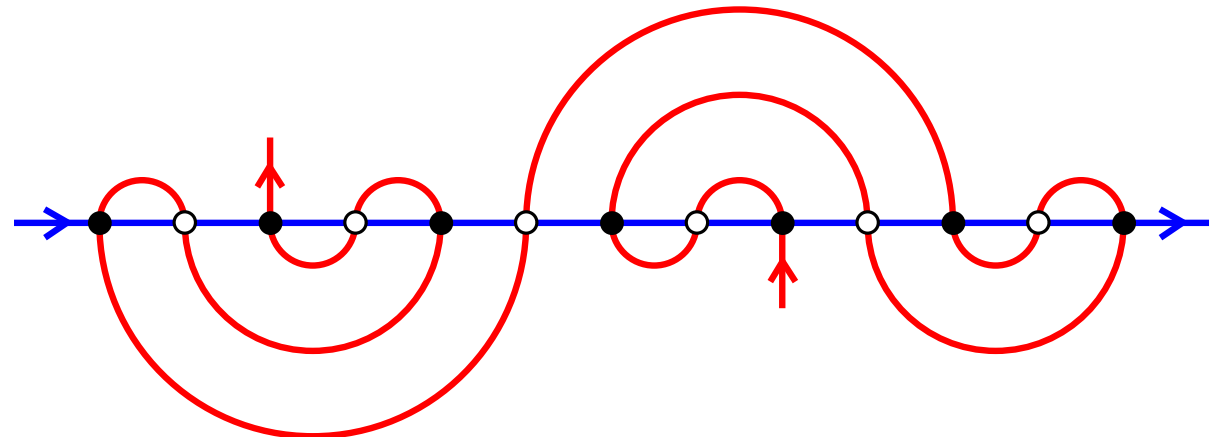

Conditions

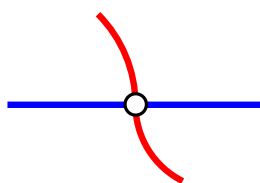
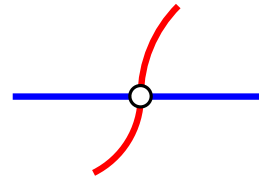
- two bipartite matchings missing a black node (one above, one below the blue line)
- white nodes are either  or 

Proof of \Leftarrow : construct permutation step by step

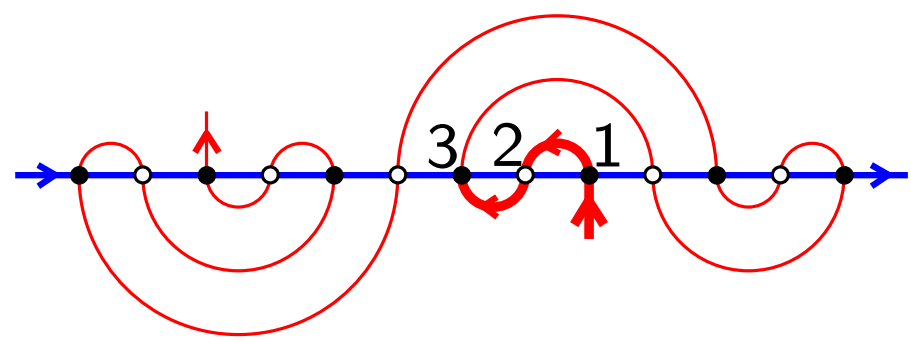

Local conditions for monotone 2-line meanders

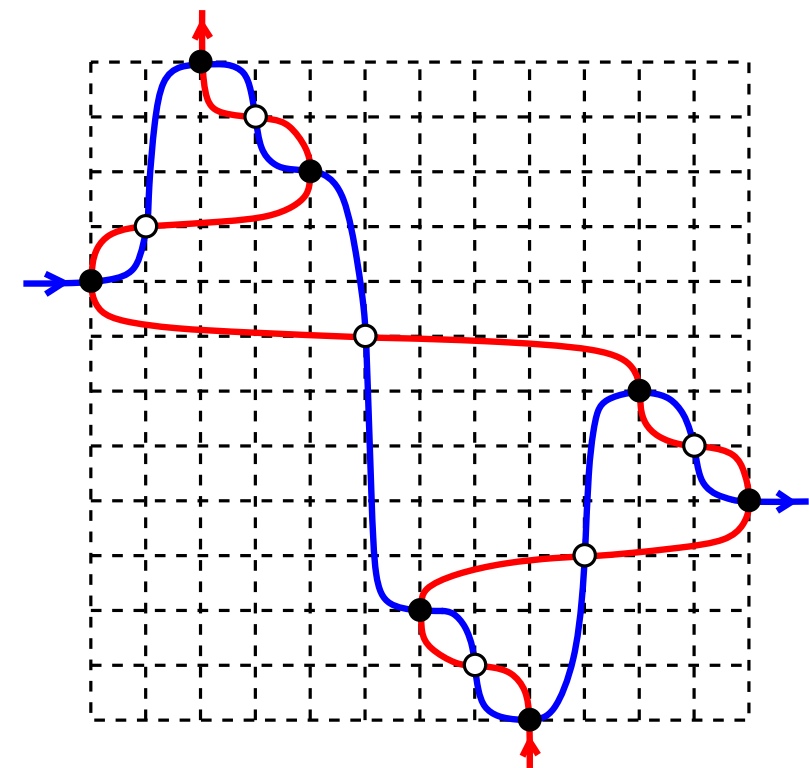

\Leftrightarrow

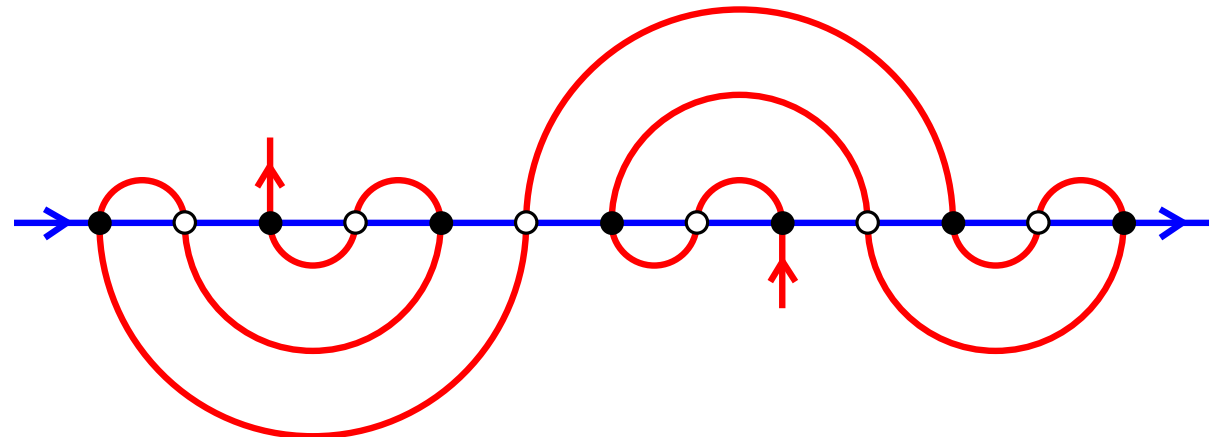

Conditions

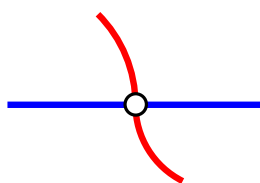
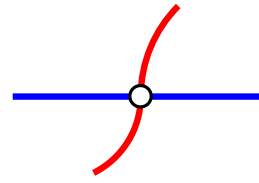
- two bipartite matchings missing a black node (one above, one below the blue line)
- white nodes are either  or 

Proof of \Leftarrow : construct permutation step by step

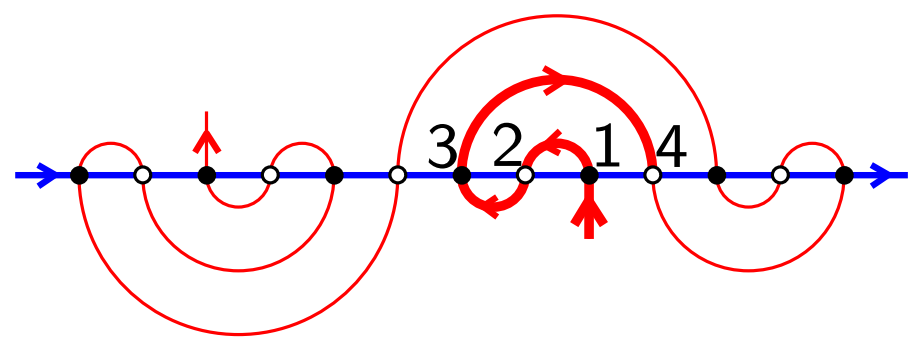

Local conditions for monotone 2-line meanders

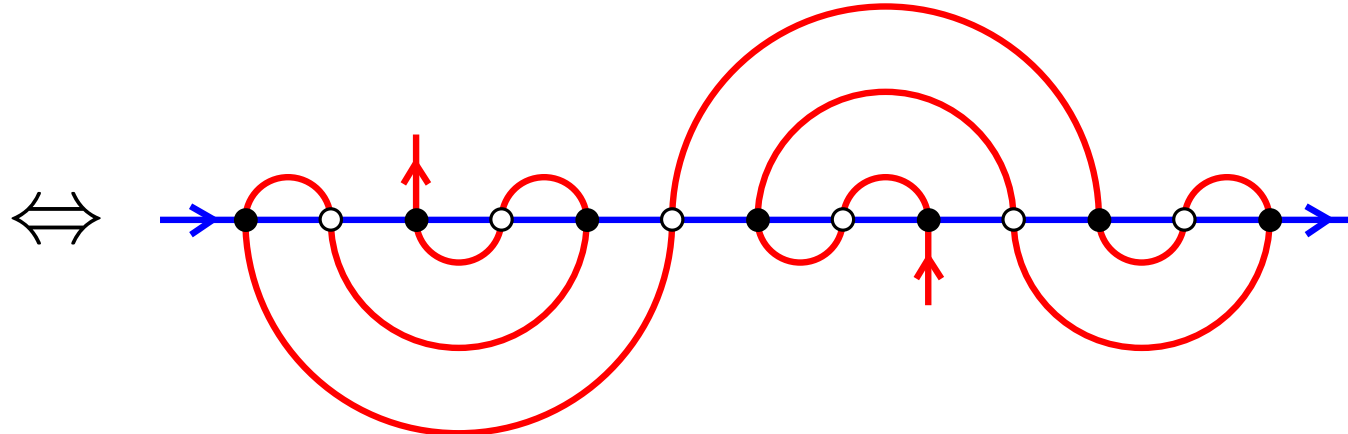
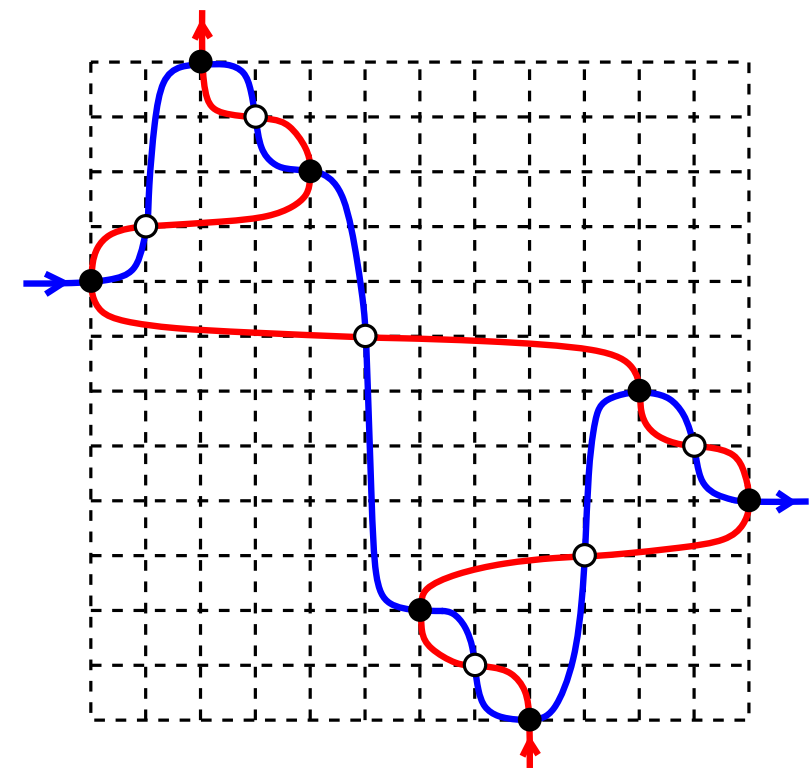

Conditions

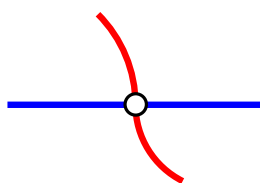
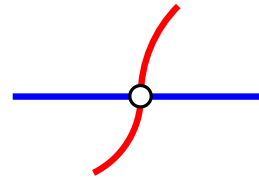
- two bipartite matchings missing a black node (one above, one below the blue line)
- white nodes are either  or 

Proof of \Leftarrow : construct permutation step by step

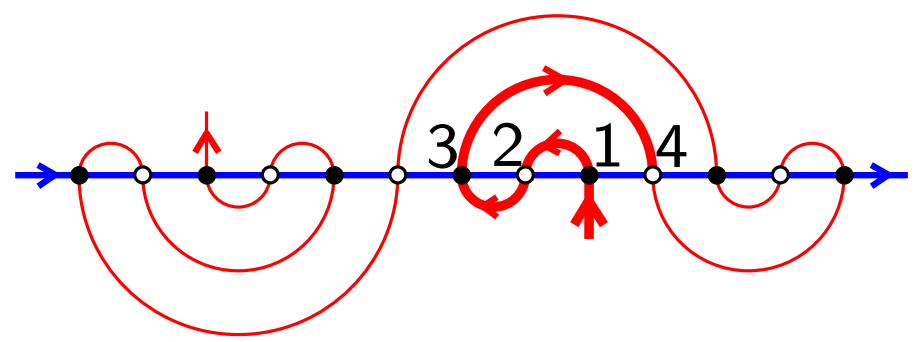
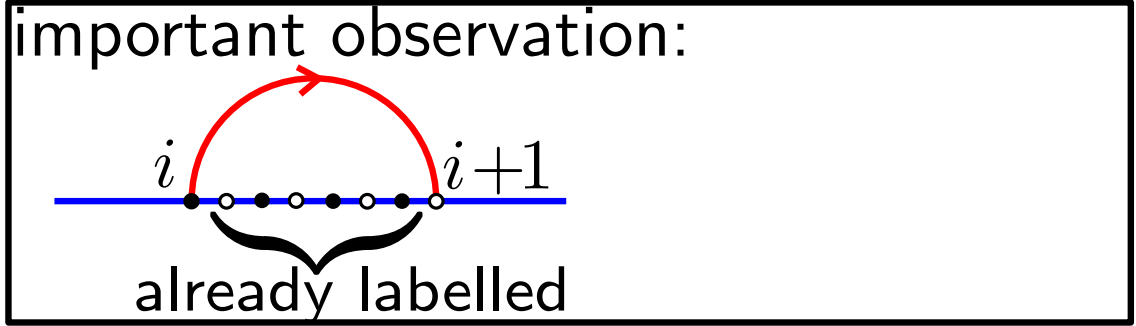

By similar argument as to show there is no red loop

Local conditions for monotone 2-line meanders

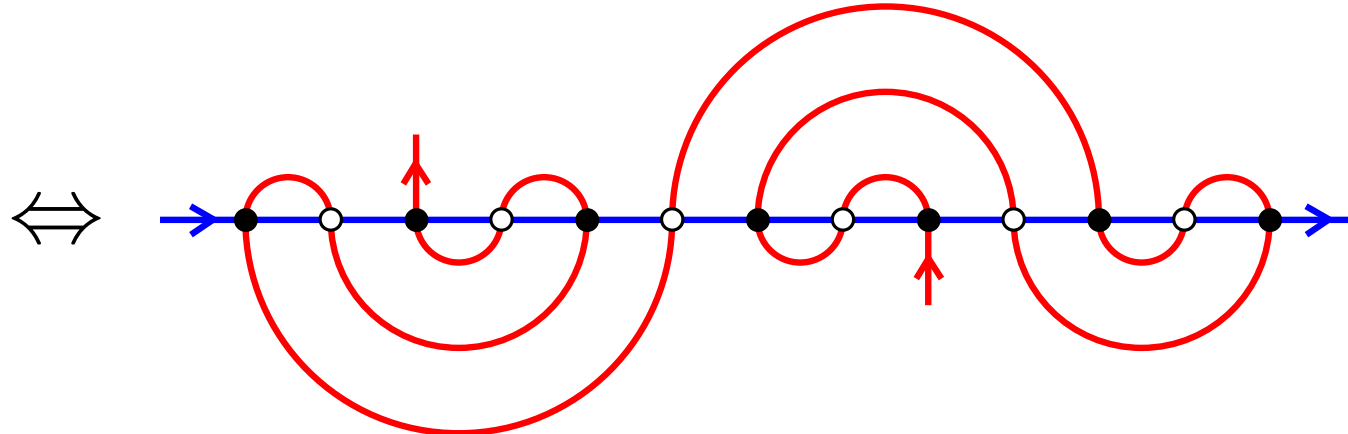
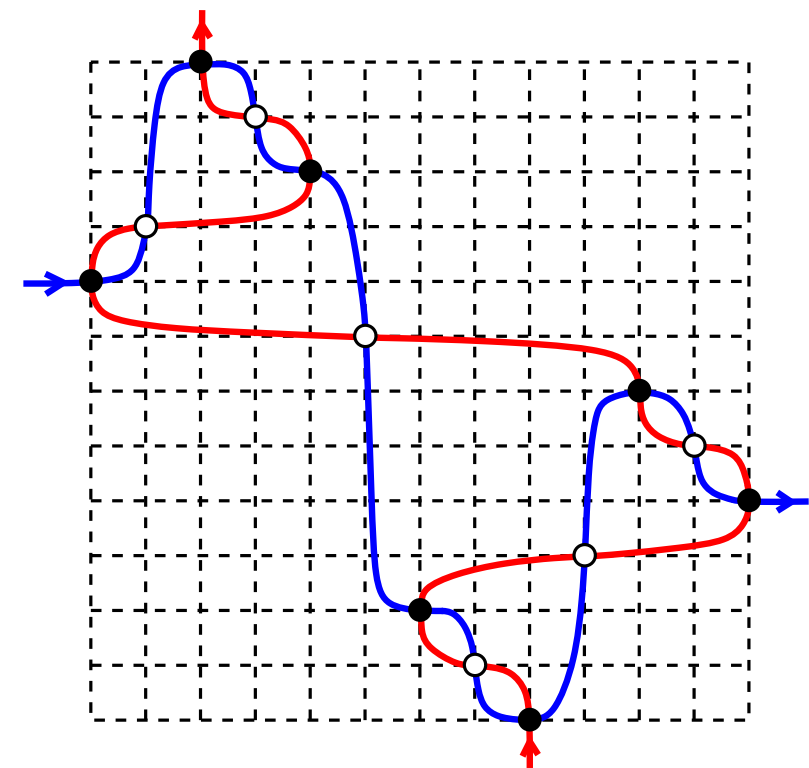

Conditions

- two bipartite matchings missing a black node (one above, one below the blue line)

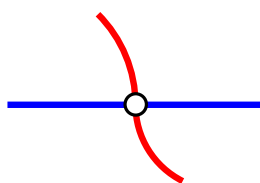
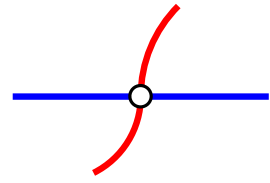
- white nodes are either  or 

Proof of \Leftarrow : construct permutation step by step

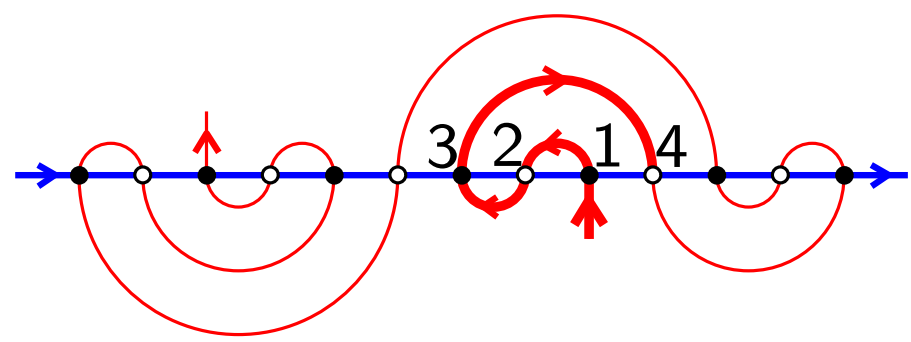
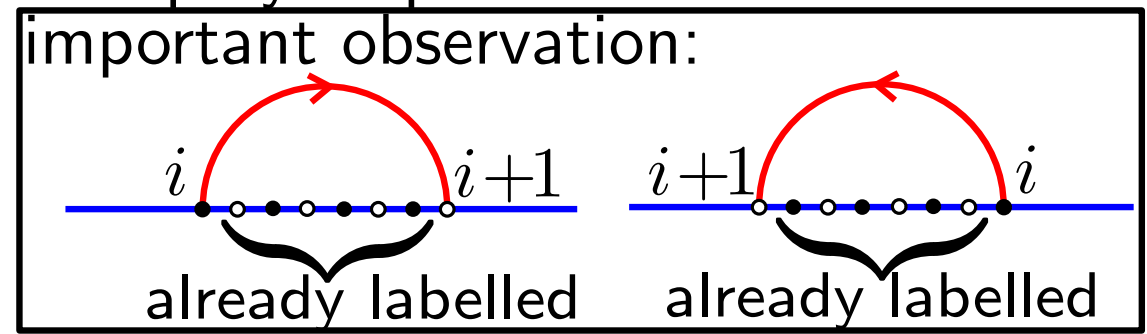

By similar argument as to show there is no red loop

Local conditions for monotone 2-line meanders

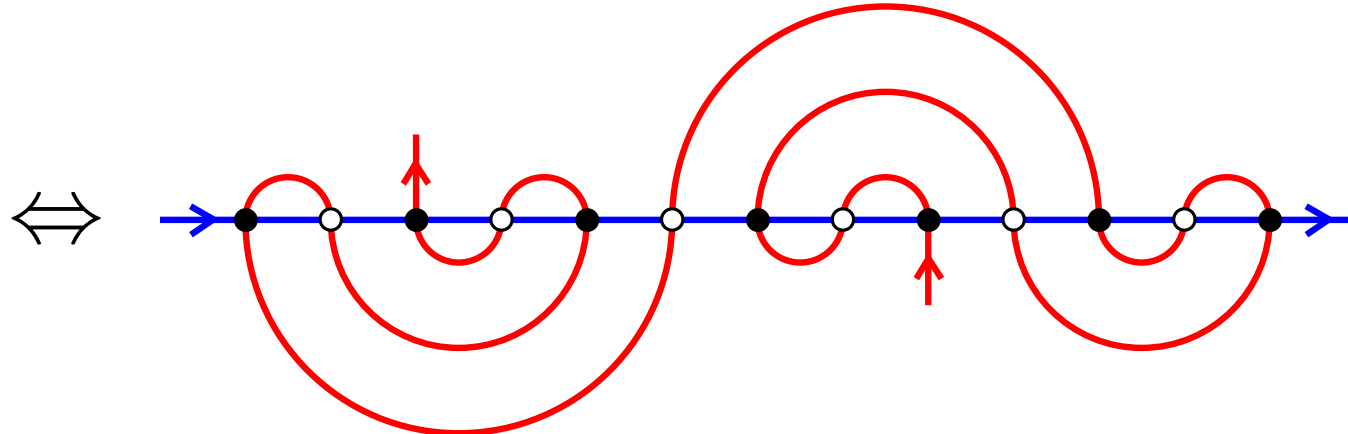
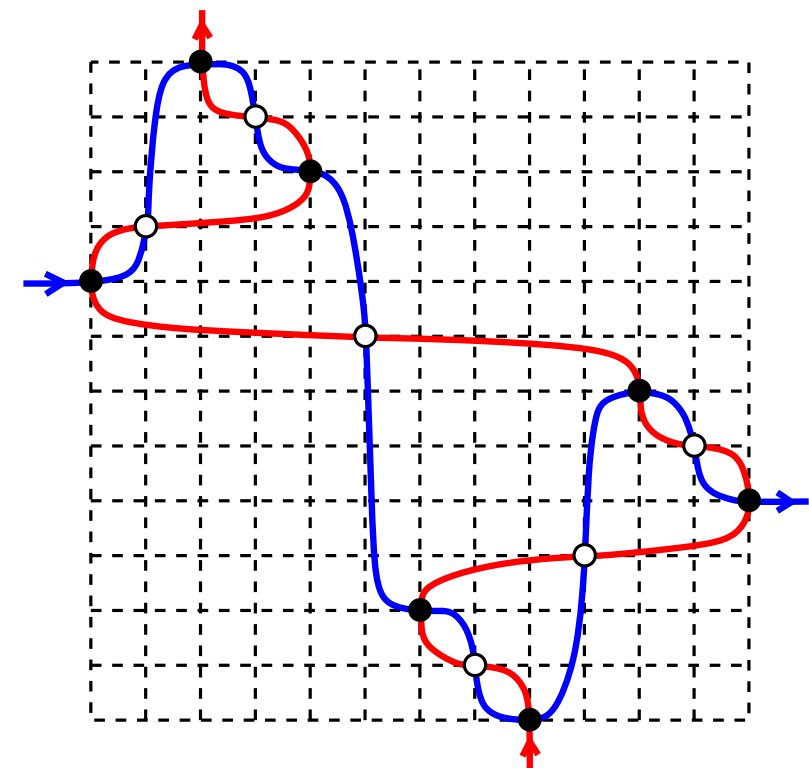

Conditions

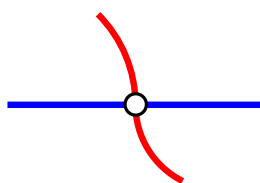
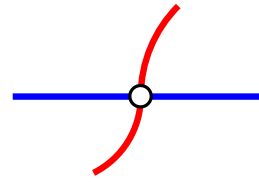
- two bipartite matchings missing a black node (one above, one below the blue line)
- white nodes are either  or 

Proof of \Leftarrow : construct permutation step by step

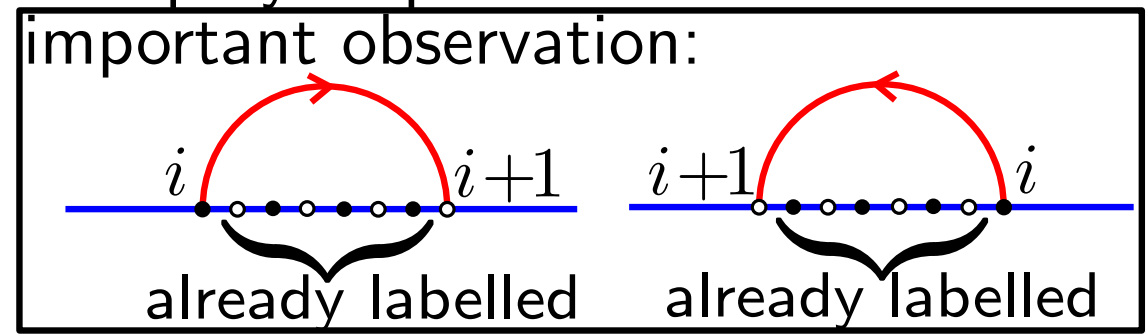
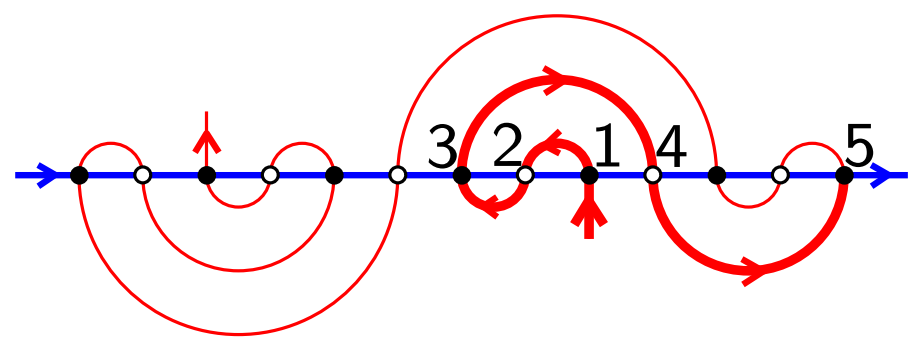

Local conditions for monotone 2-line meanders

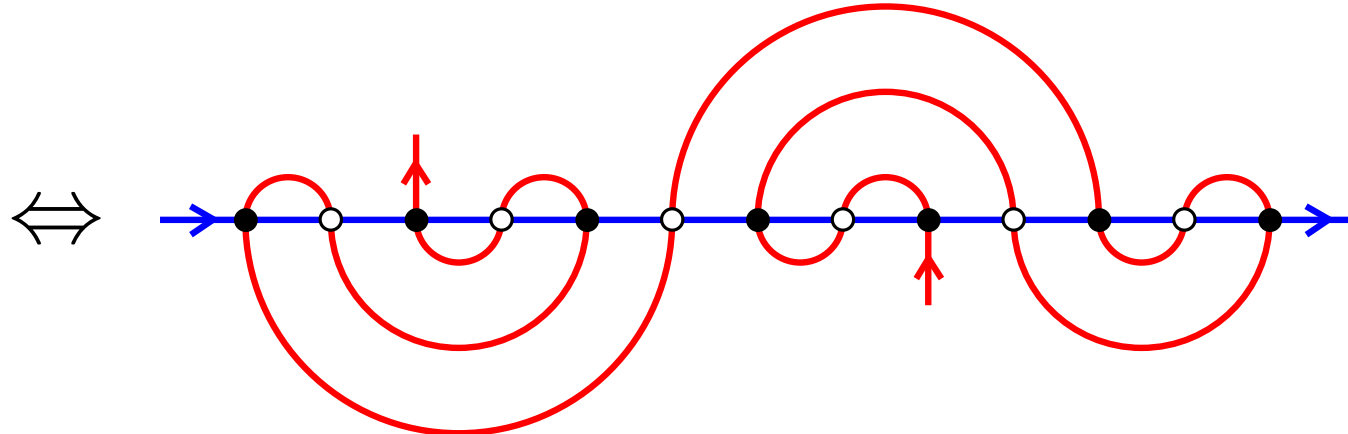
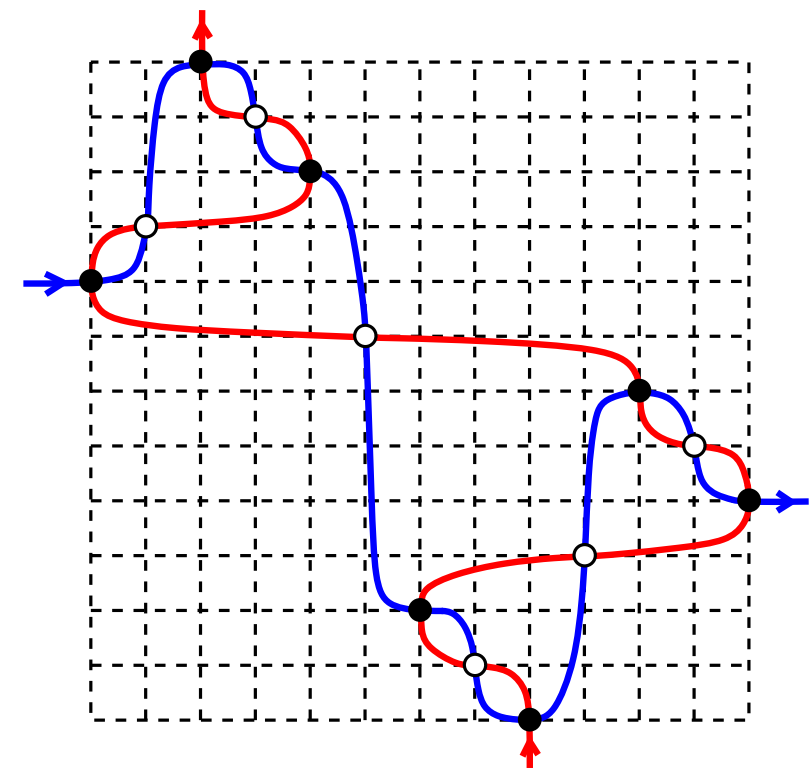

Conditions

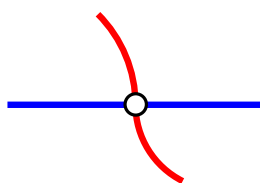
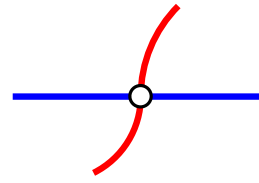
- two bipartite matchings missing a black node (one above, one below the blue line)
- white nodes are either  or 

Proof of \Leftarrow : construct permutation step by step

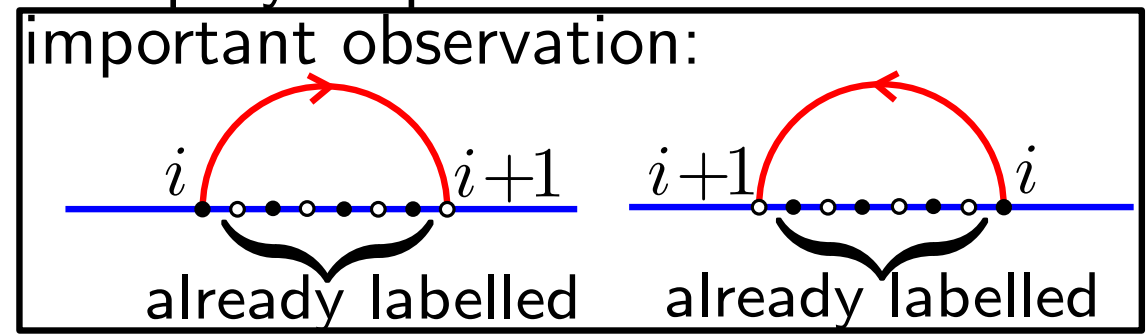
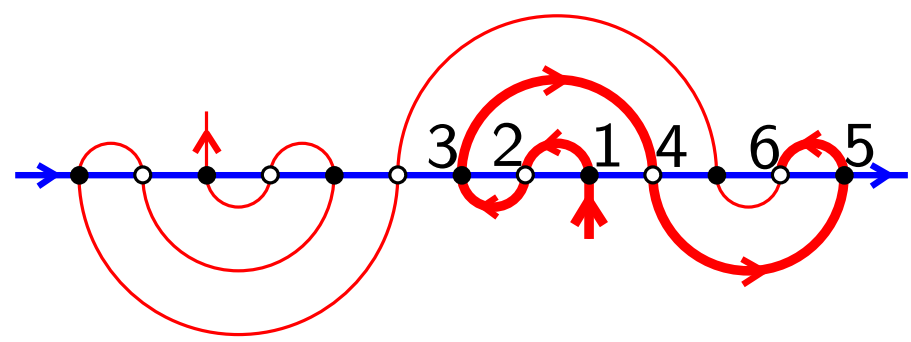

Local conditions for monotone 2-line meanders

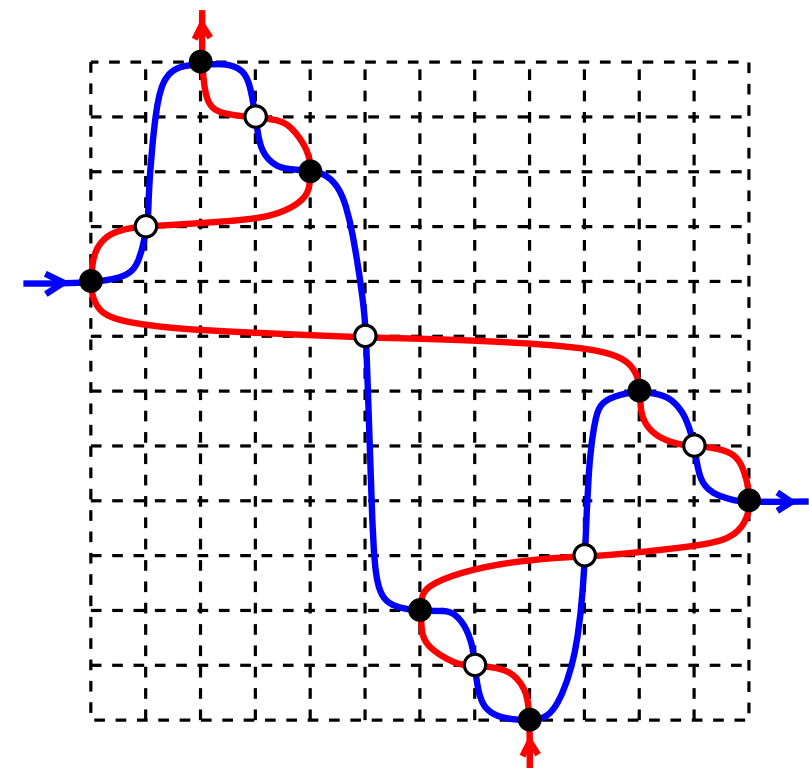

\Leftrightarrow

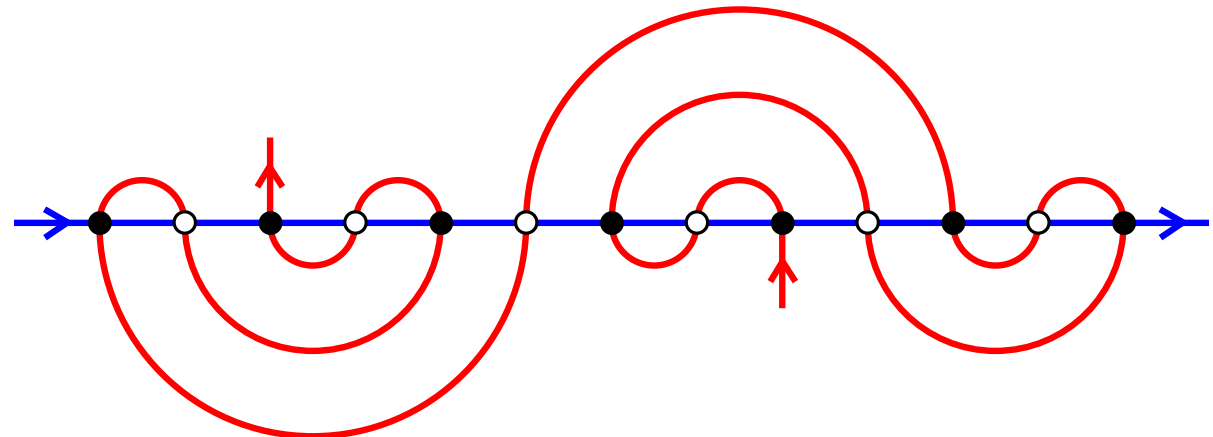

Conditions

- two bipartite matchings missing a black node (one above, one below the blue line)

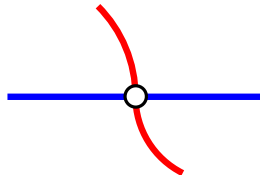
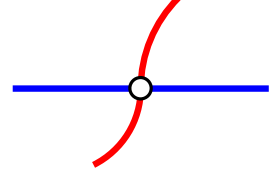
- white nodes are either  or 

Proof of \Leftarrow : construct permutation step by step

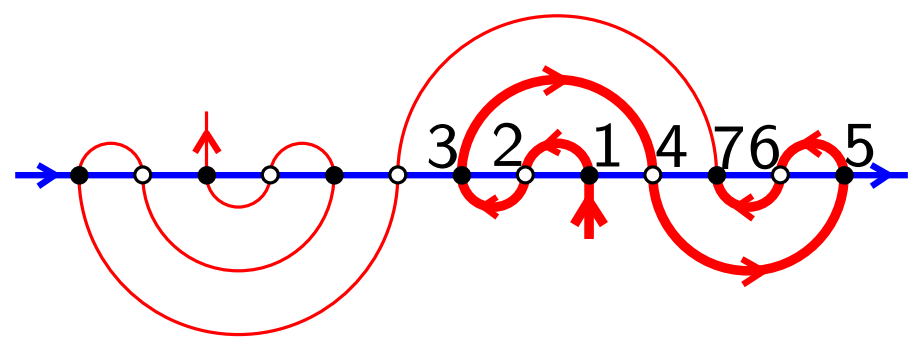
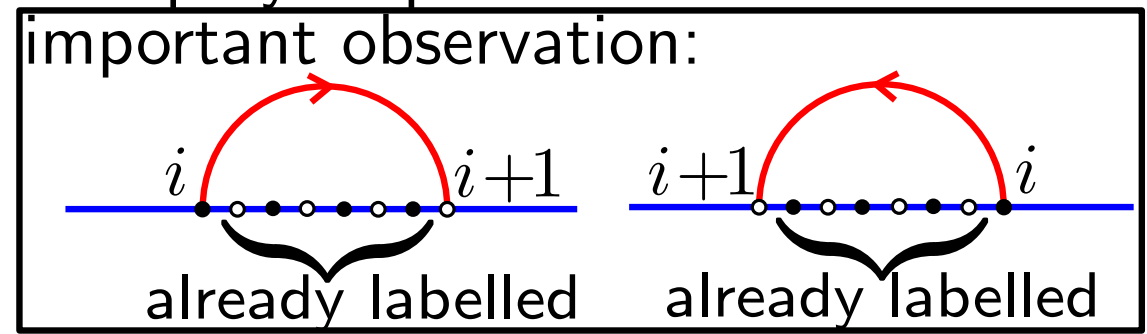

Local conditions for monotone 2-line meanders

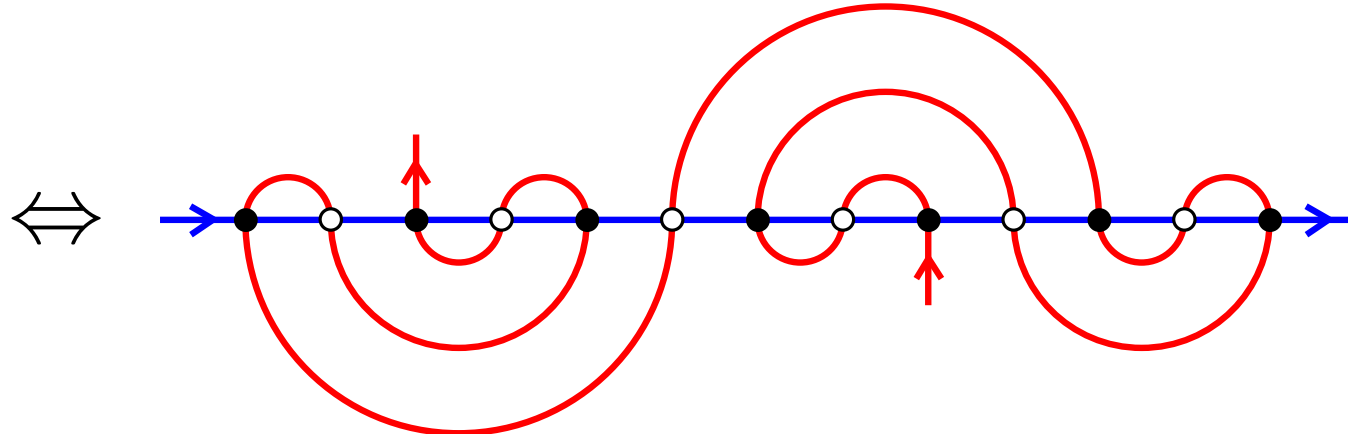
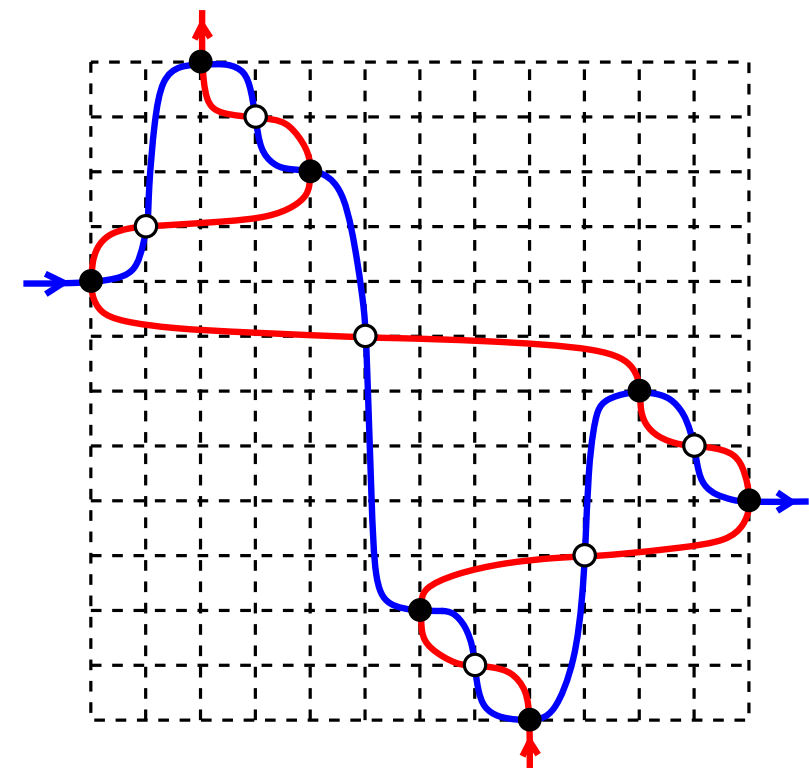

Conditions

- two bipartite matchings missing a black node (one above, one below the blue line)

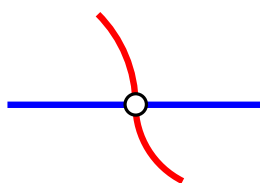
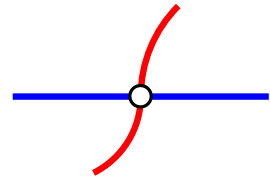
- white nodes are either  or 

Proof of \Leftarrow : construct permutation step by step

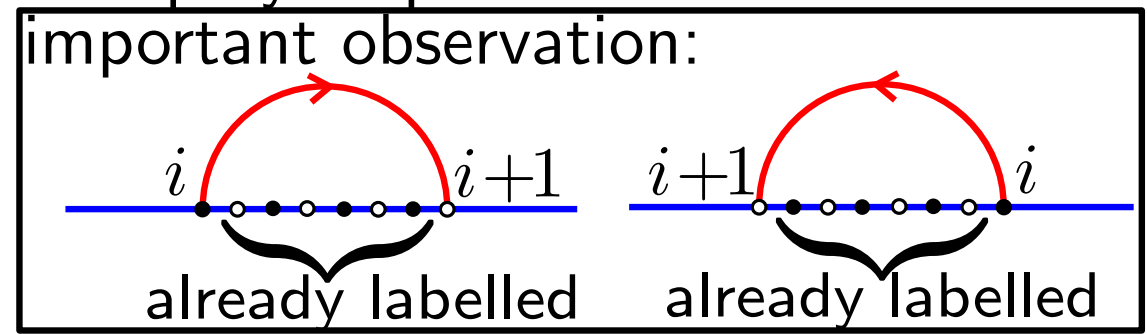
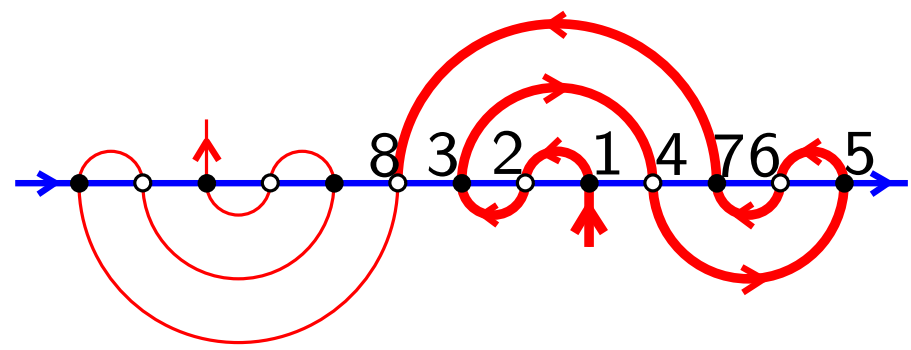

Local conditions for monotone 2-line meanders

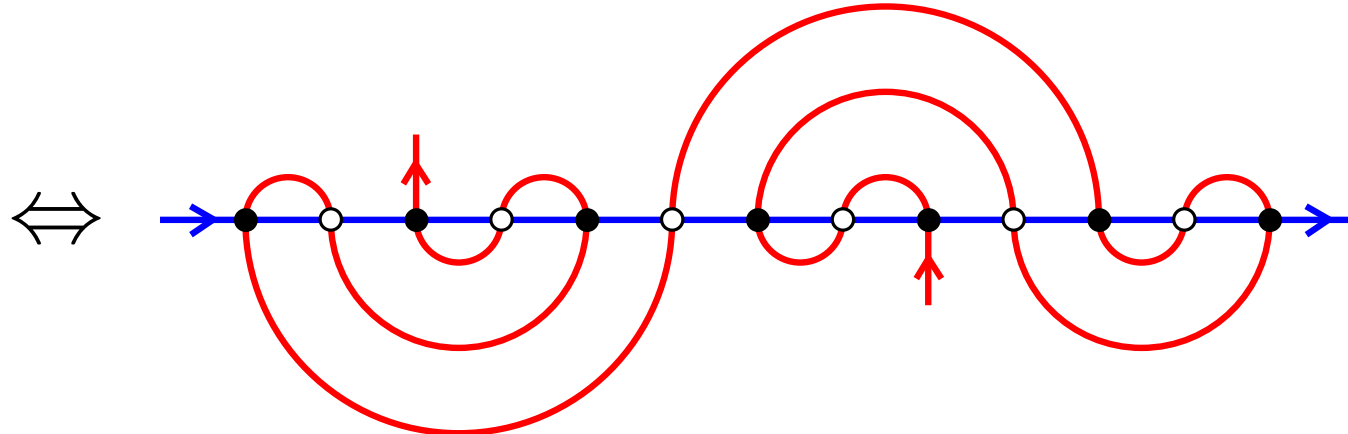
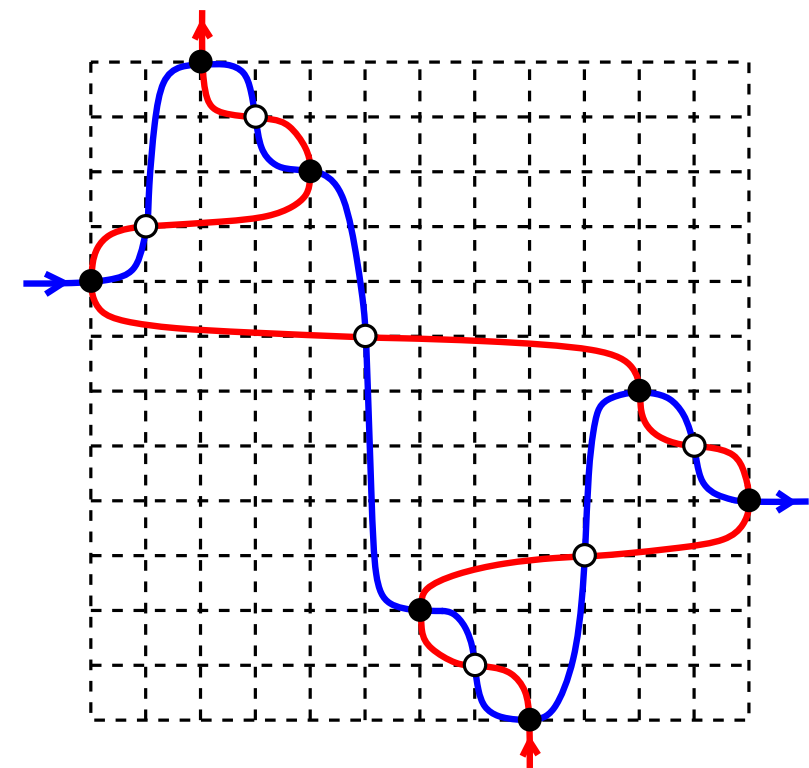

Conditions

- two bipartite matchings missing a black node (one above, one below the blue line)

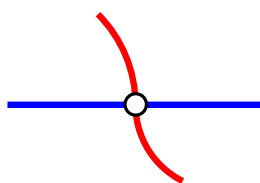
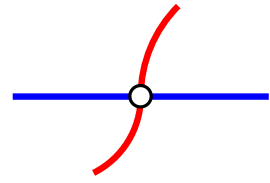
- white nodes are either  or 

Proof of \Leftarrow : construct permutation step by step

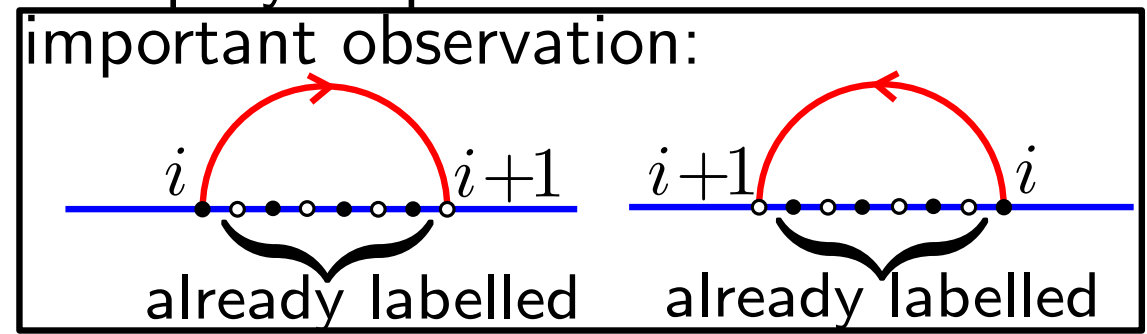
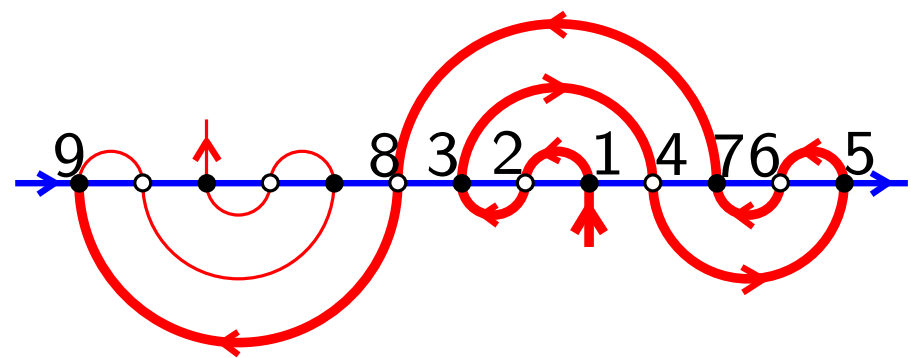

Local conditions for monotone 2-line meanders

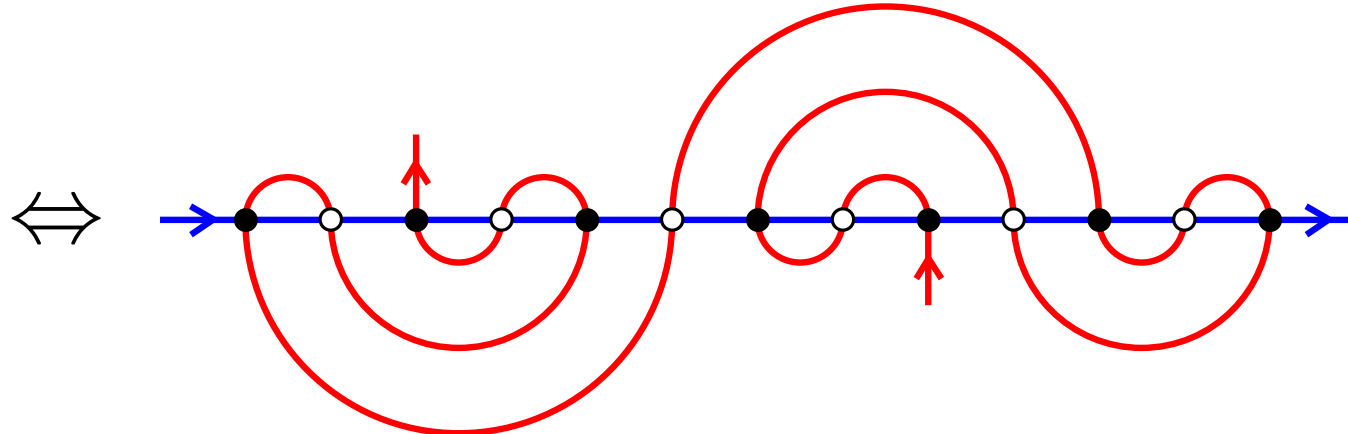
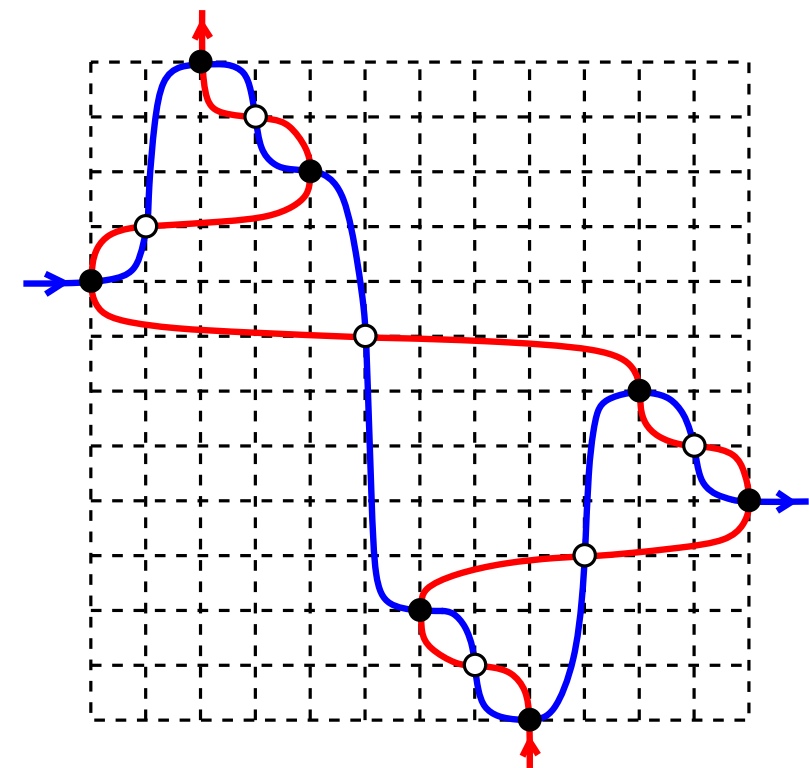

Conditions

- two bipartite matchings missing a black node (one above, one below the blue line)
- white nodes are either

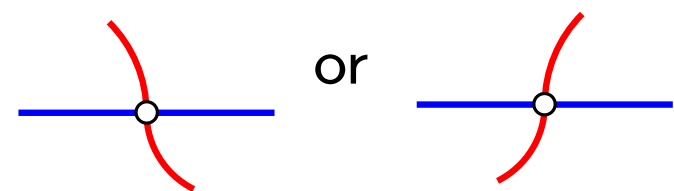

Proof of \Leftarrow : construct permutation step by step

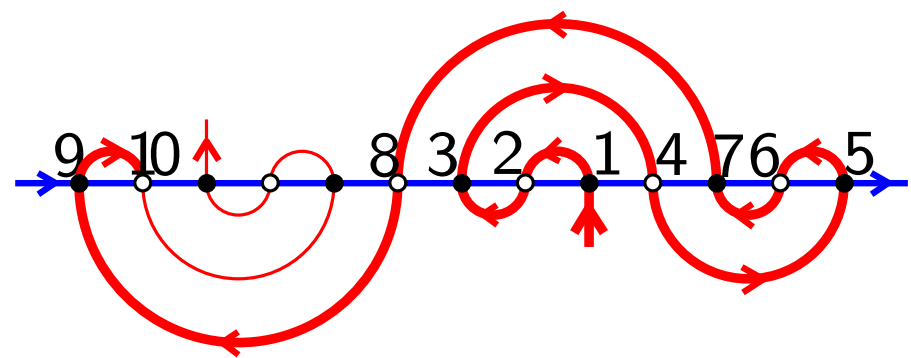
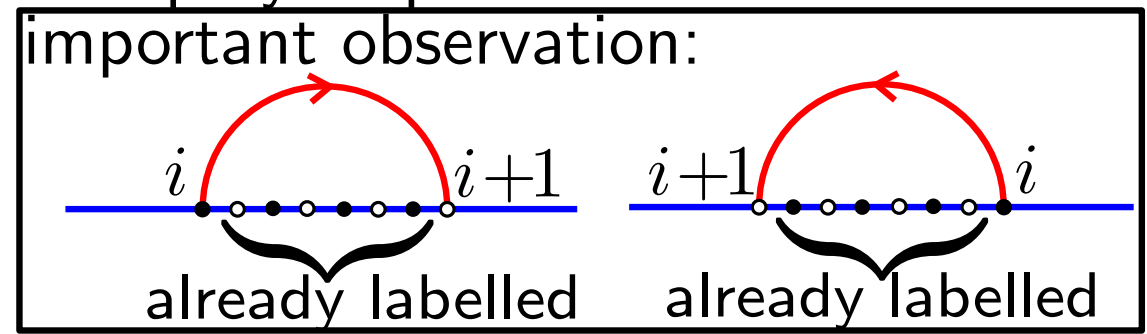

Local conditions for monotone 2-line meanders

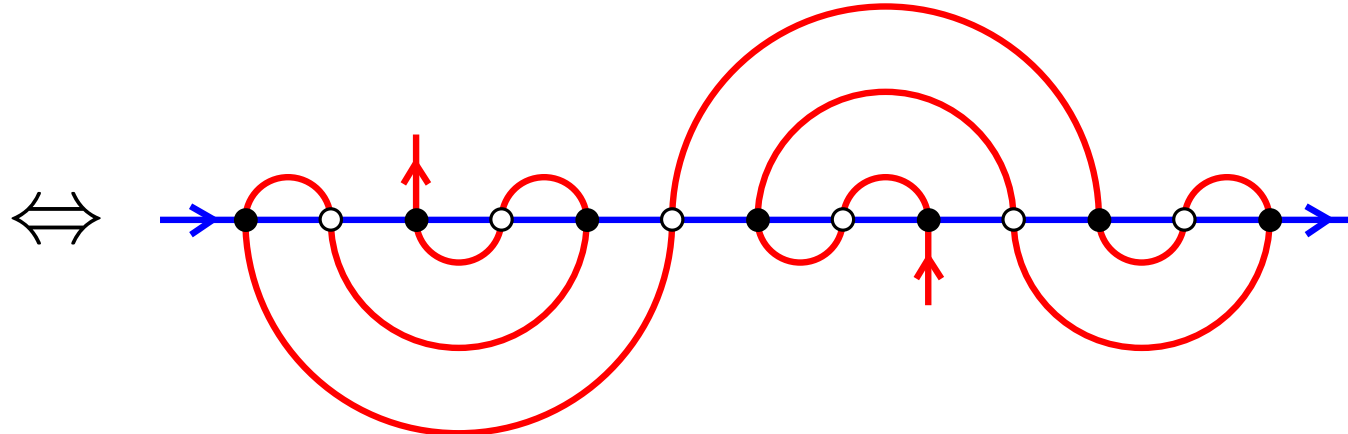
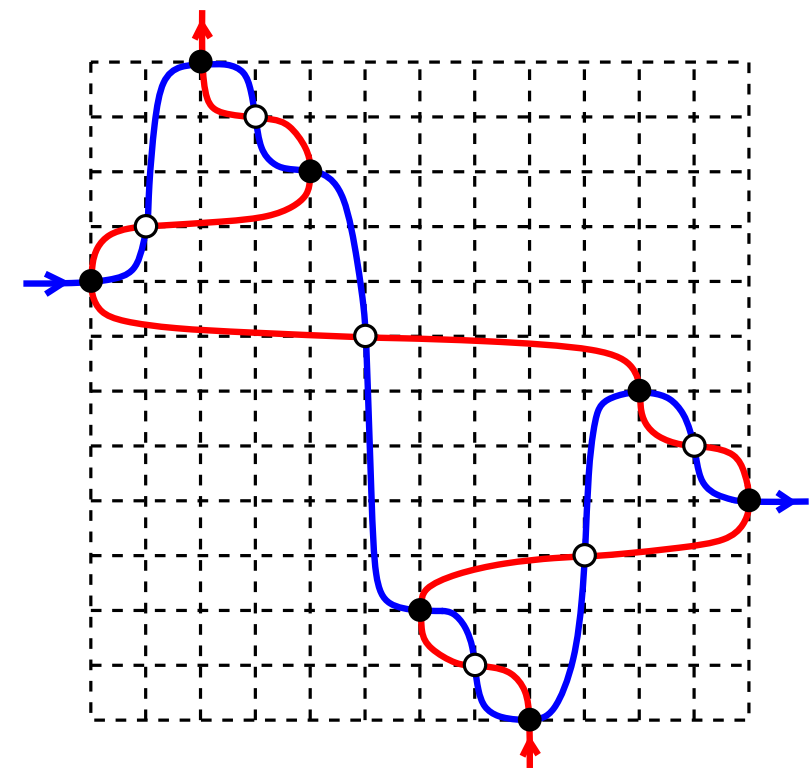

Conditions

- two bipartite matchings missing a black node (one above, one below the blue line)

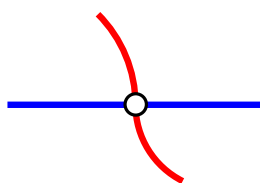
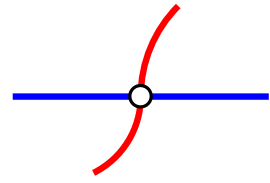
- white nodes are either  or 

Proof of \Leftarrow : construct permutation step by step

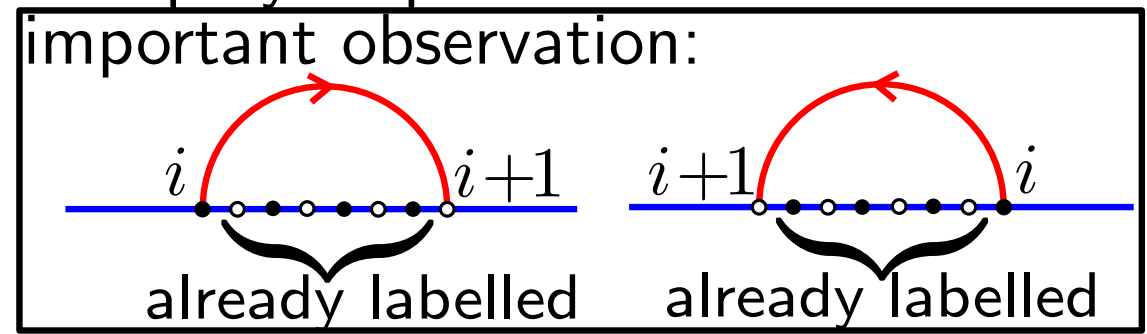
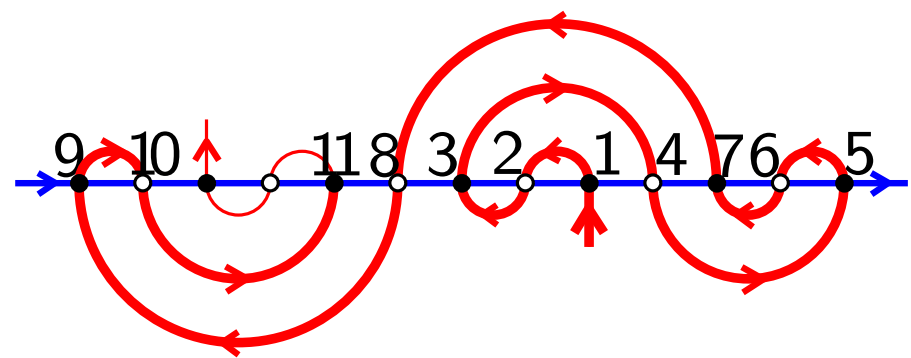

Local conditions for monotone 2-line meanders

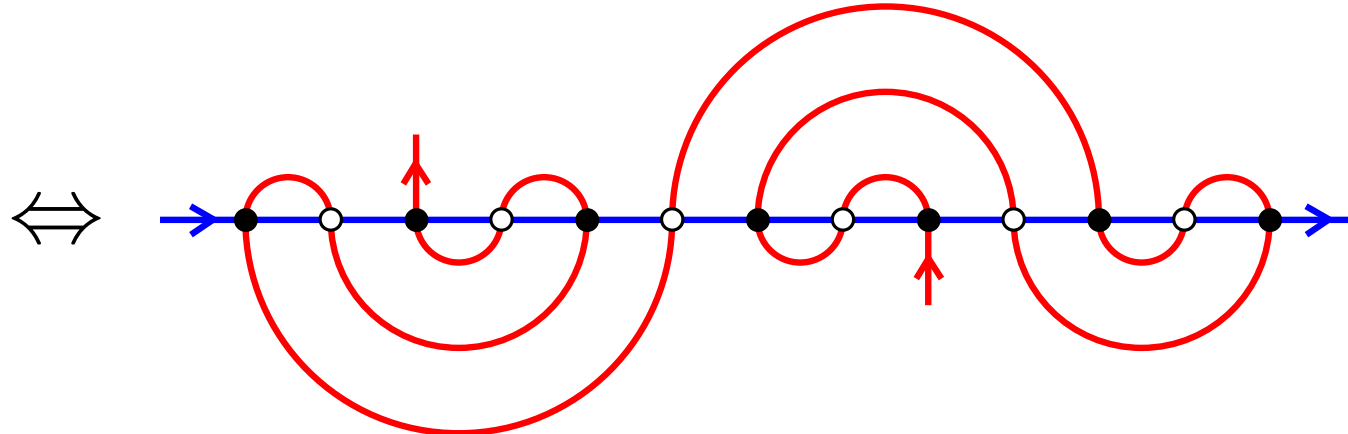
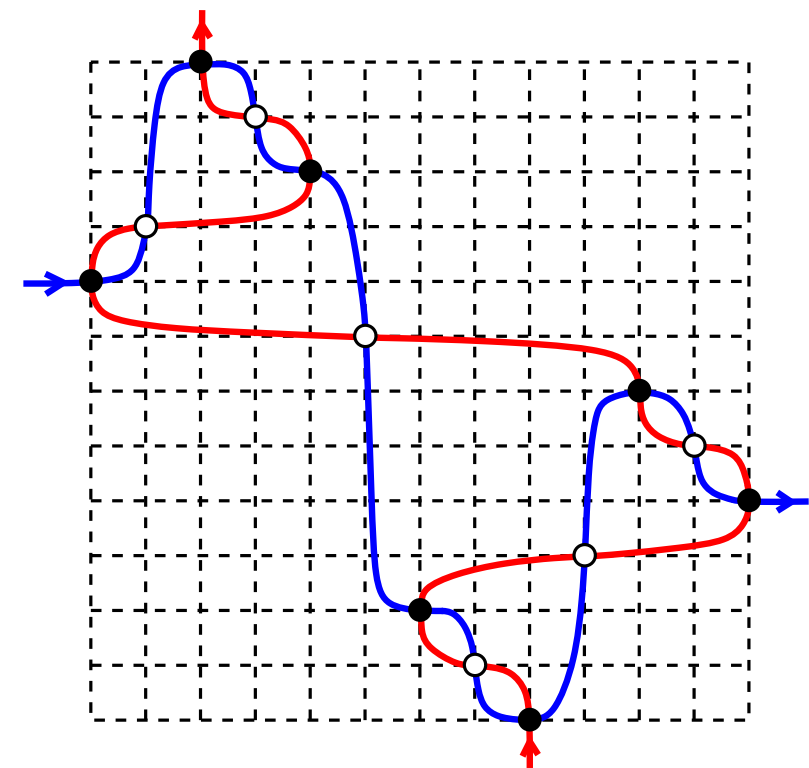

Conditions

- two bipartite matchings missing a black node (one above, one below the blue line)

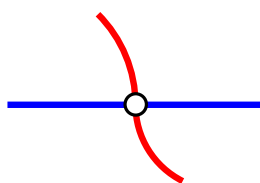
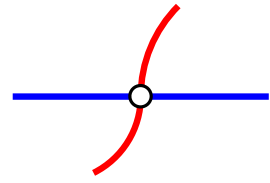
- white nodes are either  or 

Proof of \Leftarrow : construct permutation step by step

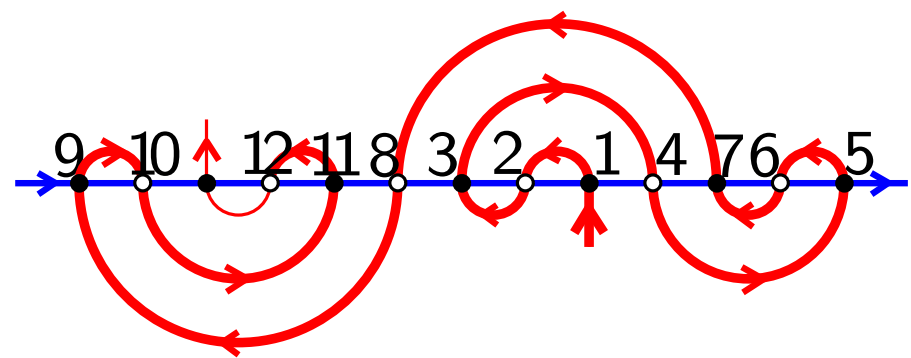
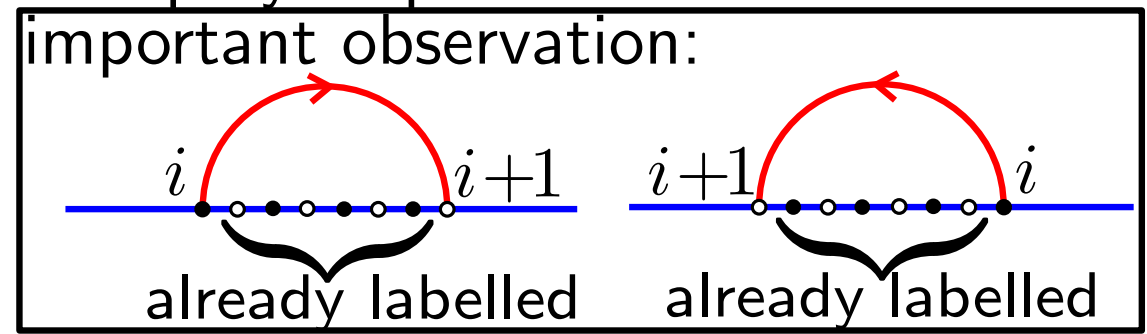

Local conditions for monotone 2-line meanders

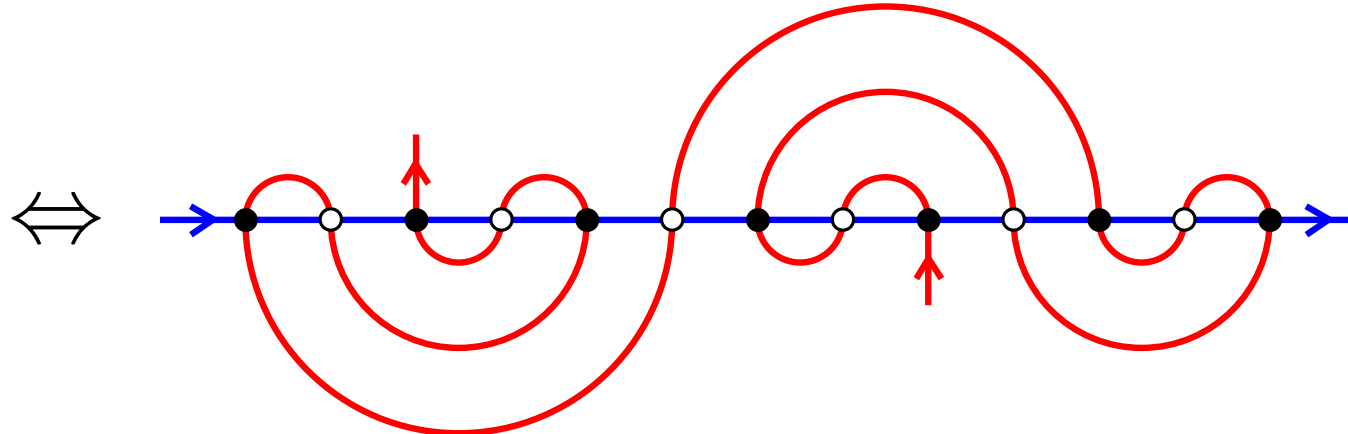
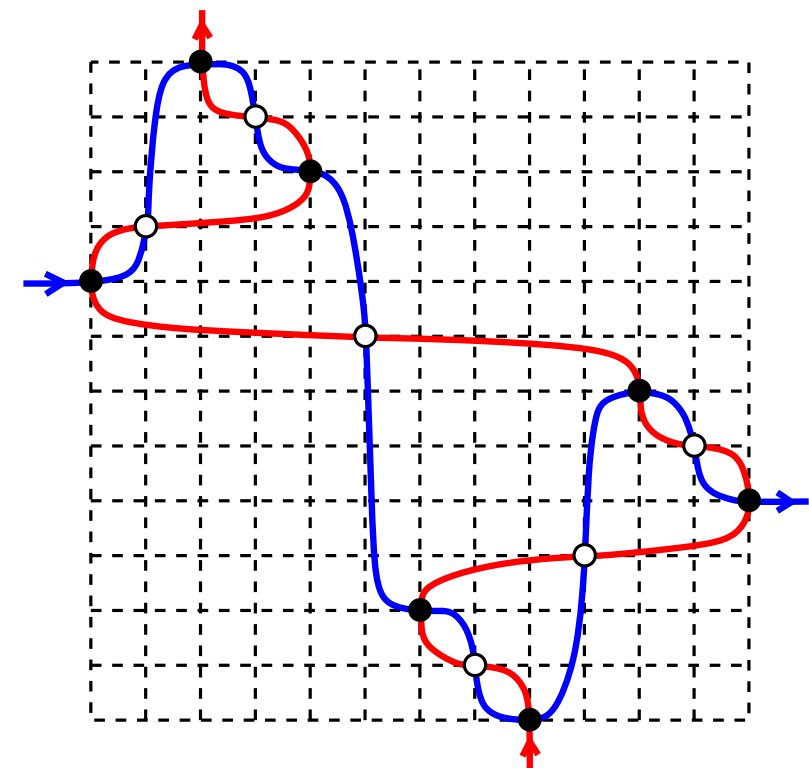

Conditions

- two bipartite matchings missing a black node (one above, one below the blue line)

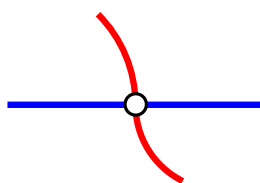
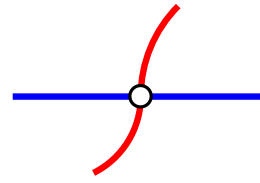
- white nodes are either  or 

Proof of \Leftarrow : construct permutation step by step

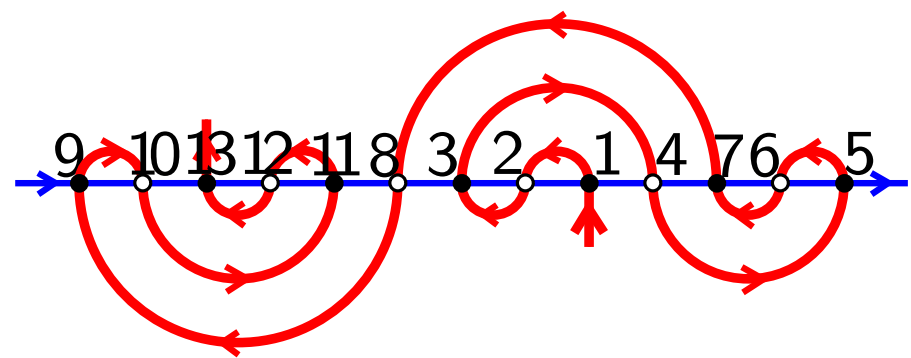
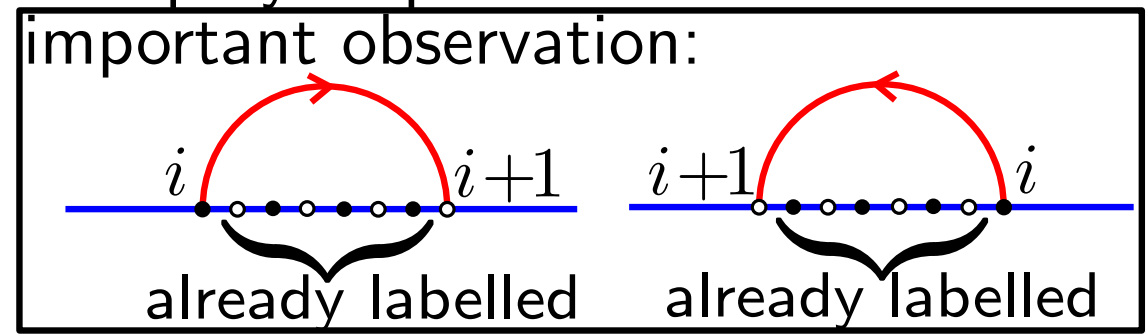

Local conditions for monotone 2-line meanders

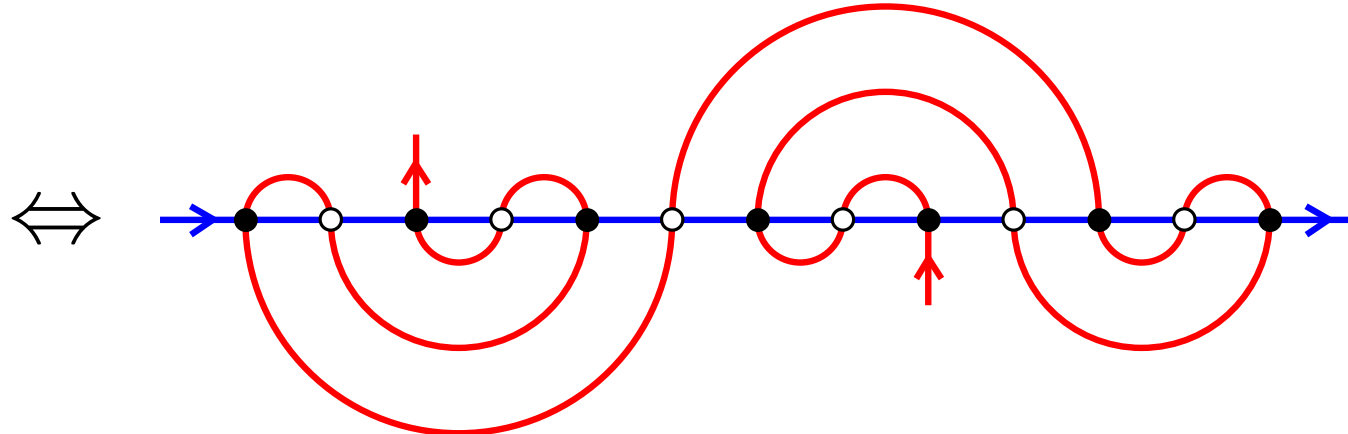
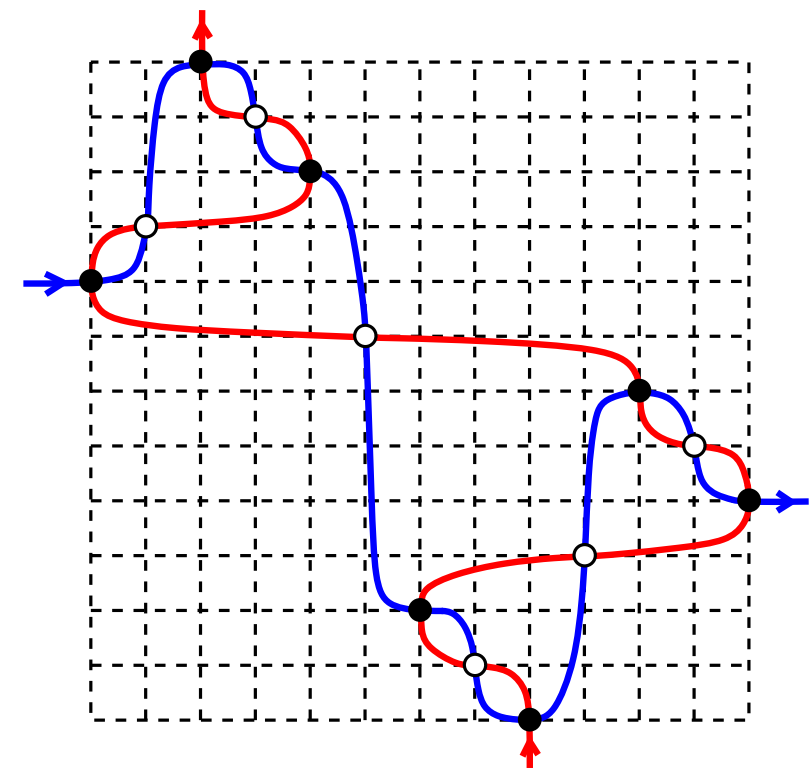

Conditions

- two bipartite matchings missing a black node (one above, one below the blue line)

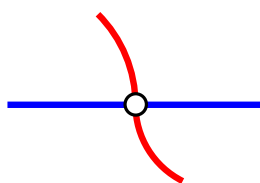
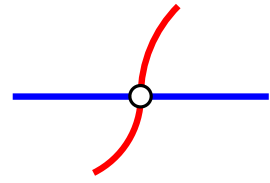
- white nodes are either  or 

Proof of \Leftarrow : construct permutation step by step

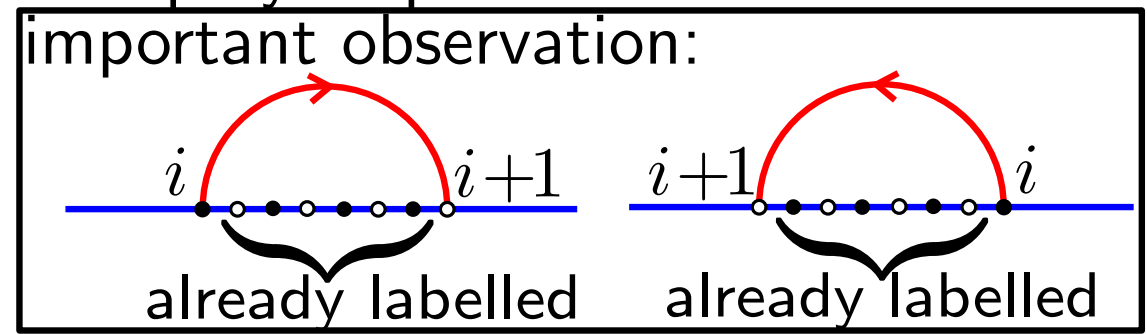
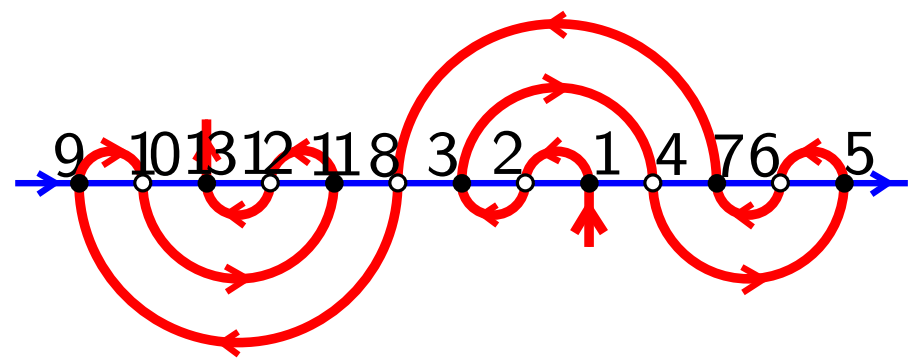

Local conditions for monotone 2-line meanders

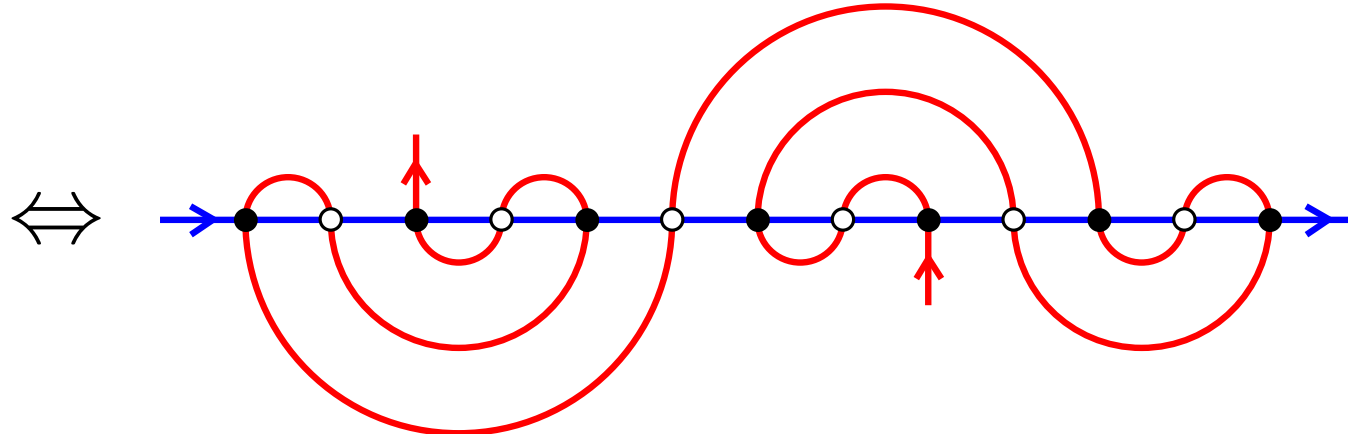
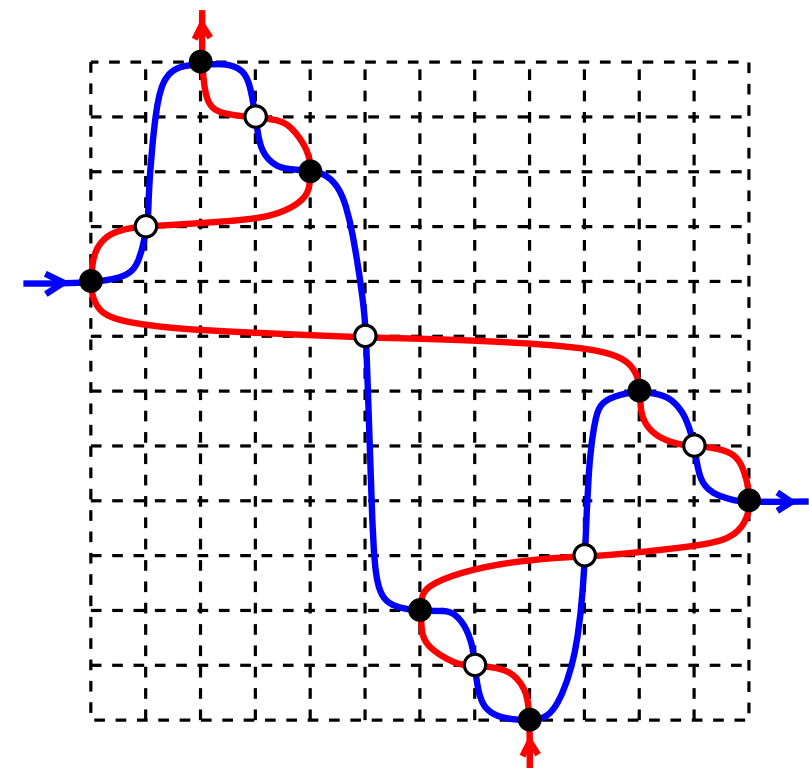

Conditions

- two bipartite matchings missing a black node (one above, one below the blue line)
- white nodes are either

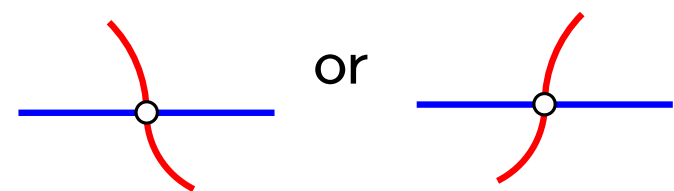

Proof of \Leftarrow : construct permutation step by step

Similarly:

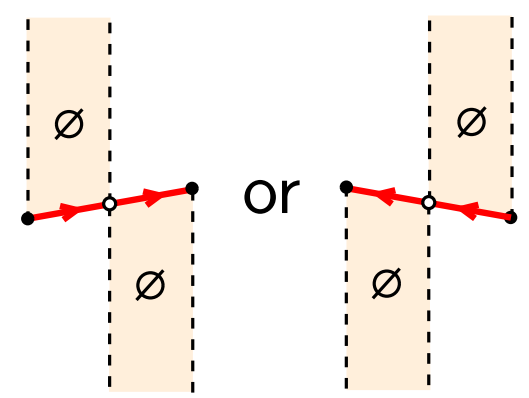
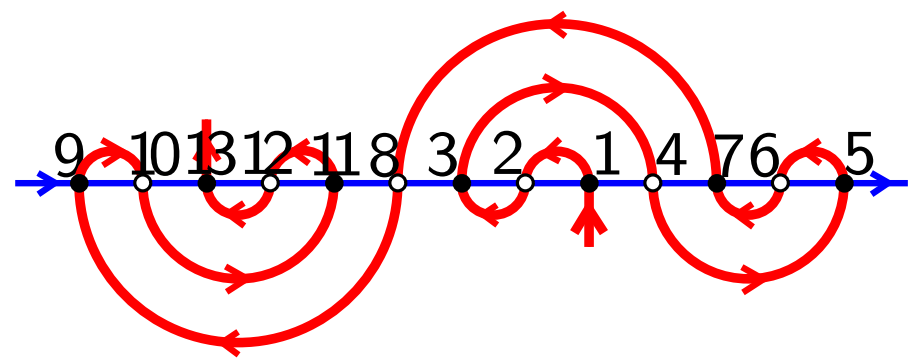

Encoding a monotone 2-line meander

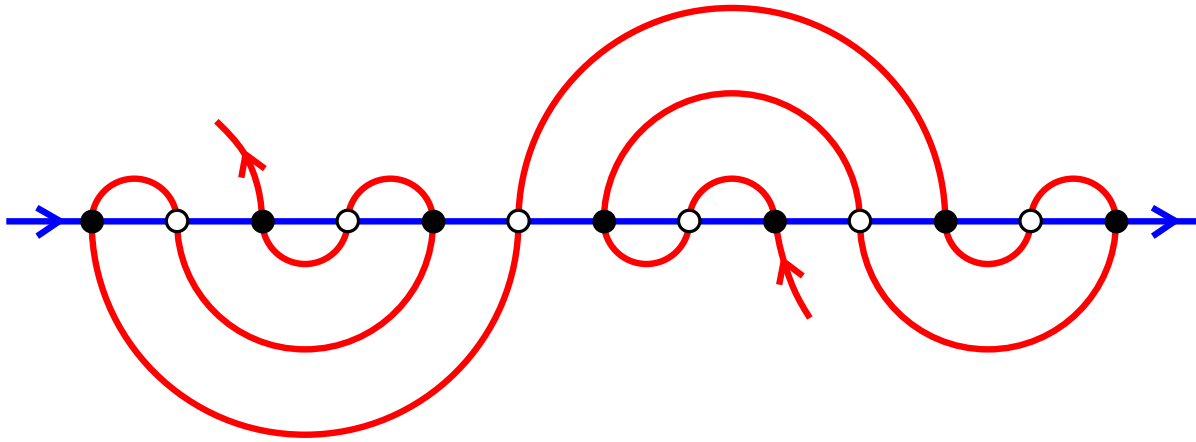

Encoding a monotone 2-line meander

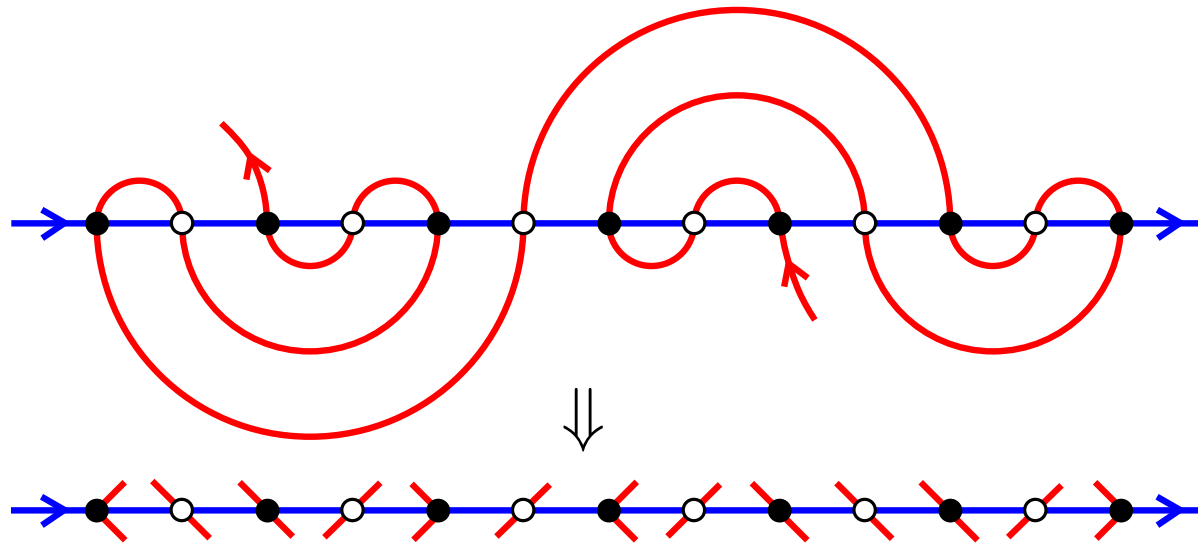

Encoding a monotone 2-line meander

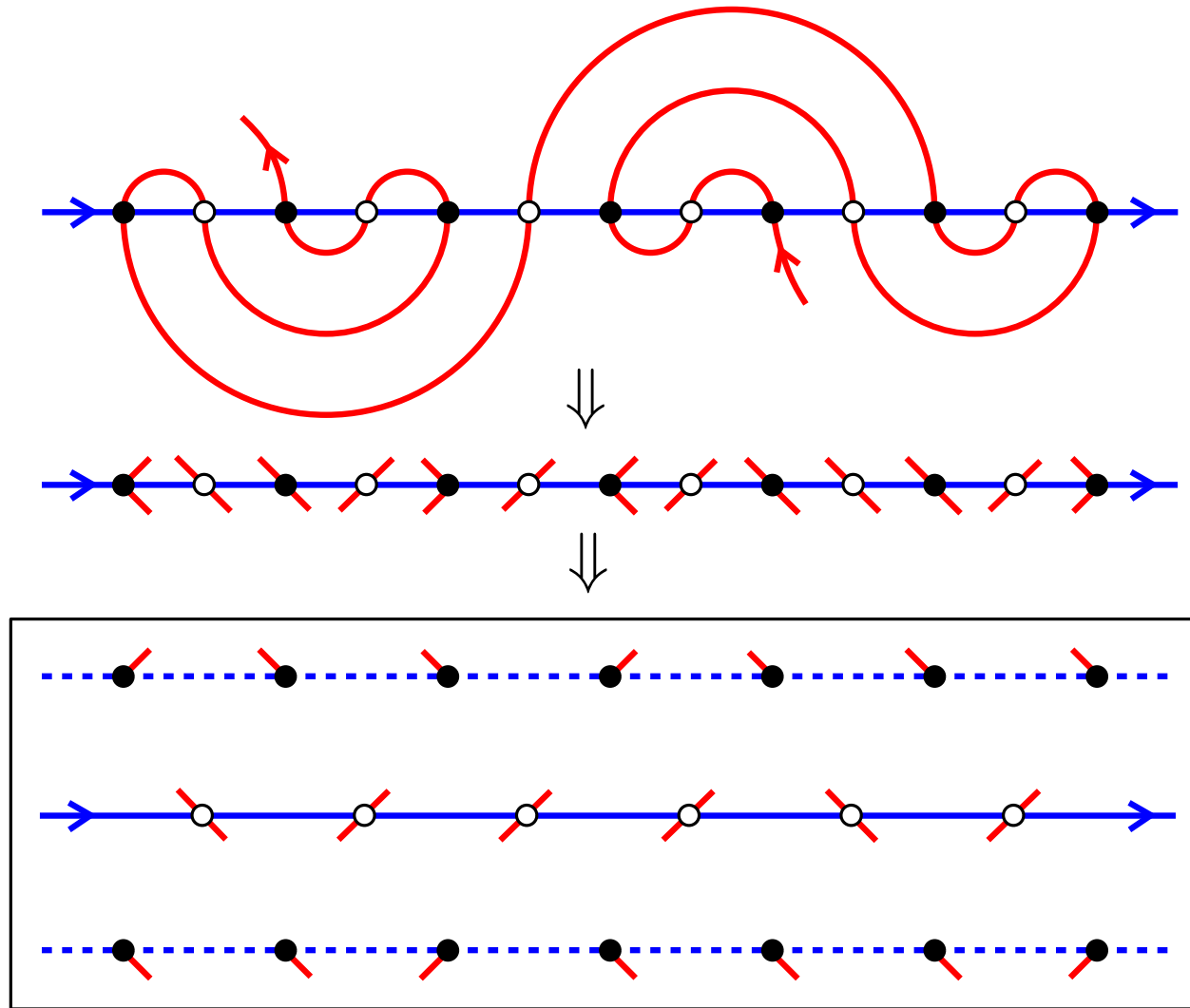

Encoding a monotone 2-line meander

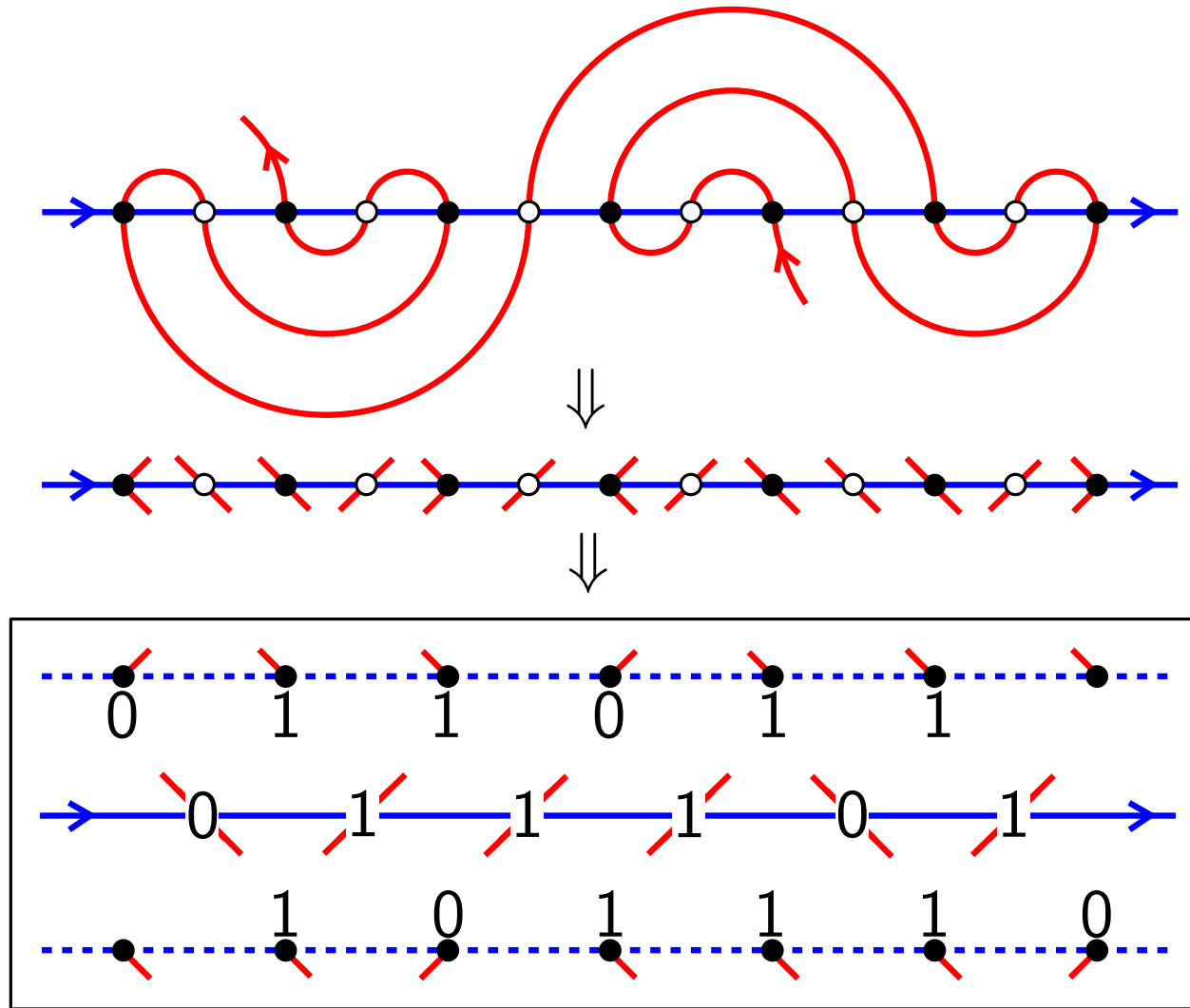

Encoding a monotone 2-line meander

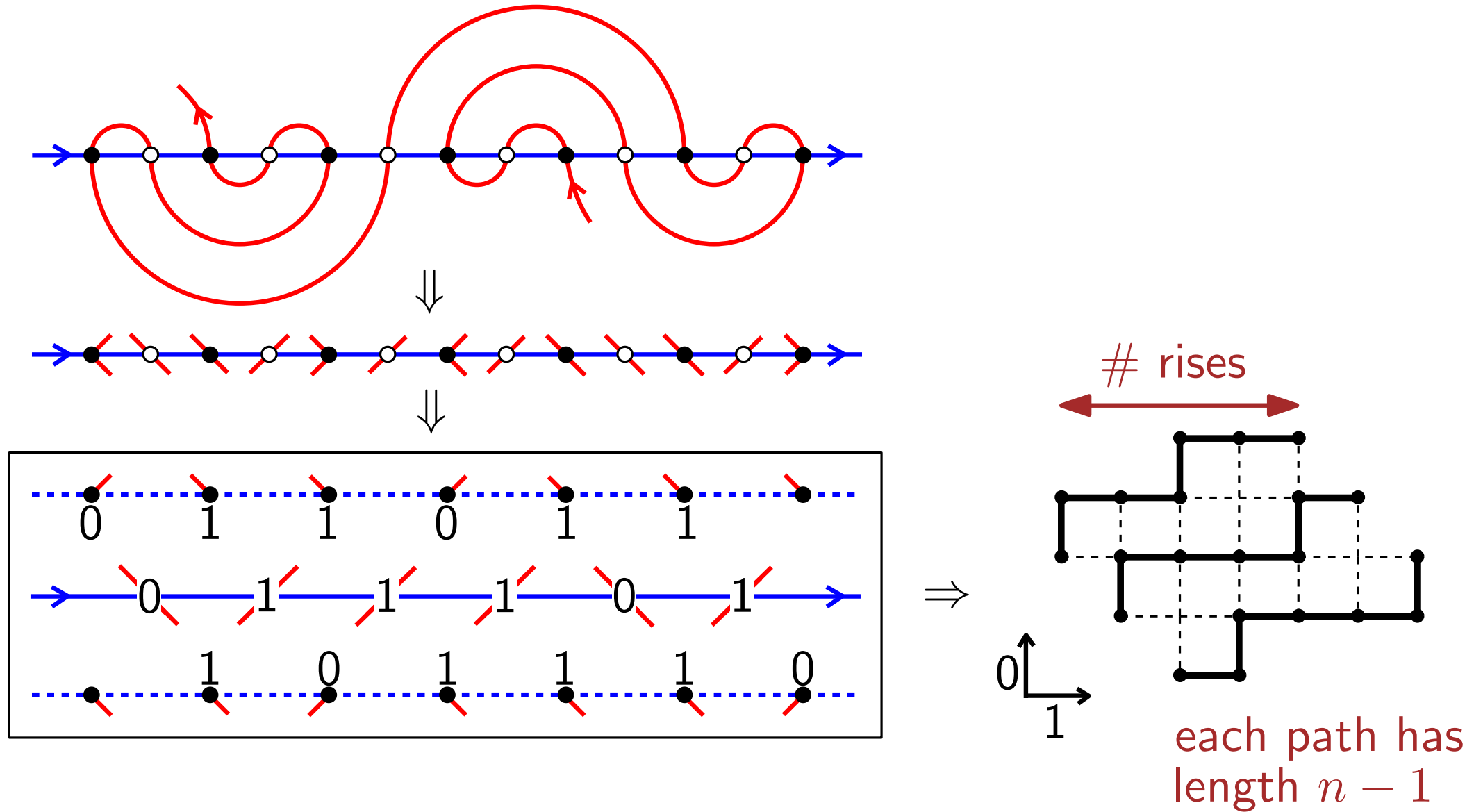

Encoding a monotone 2-line meander

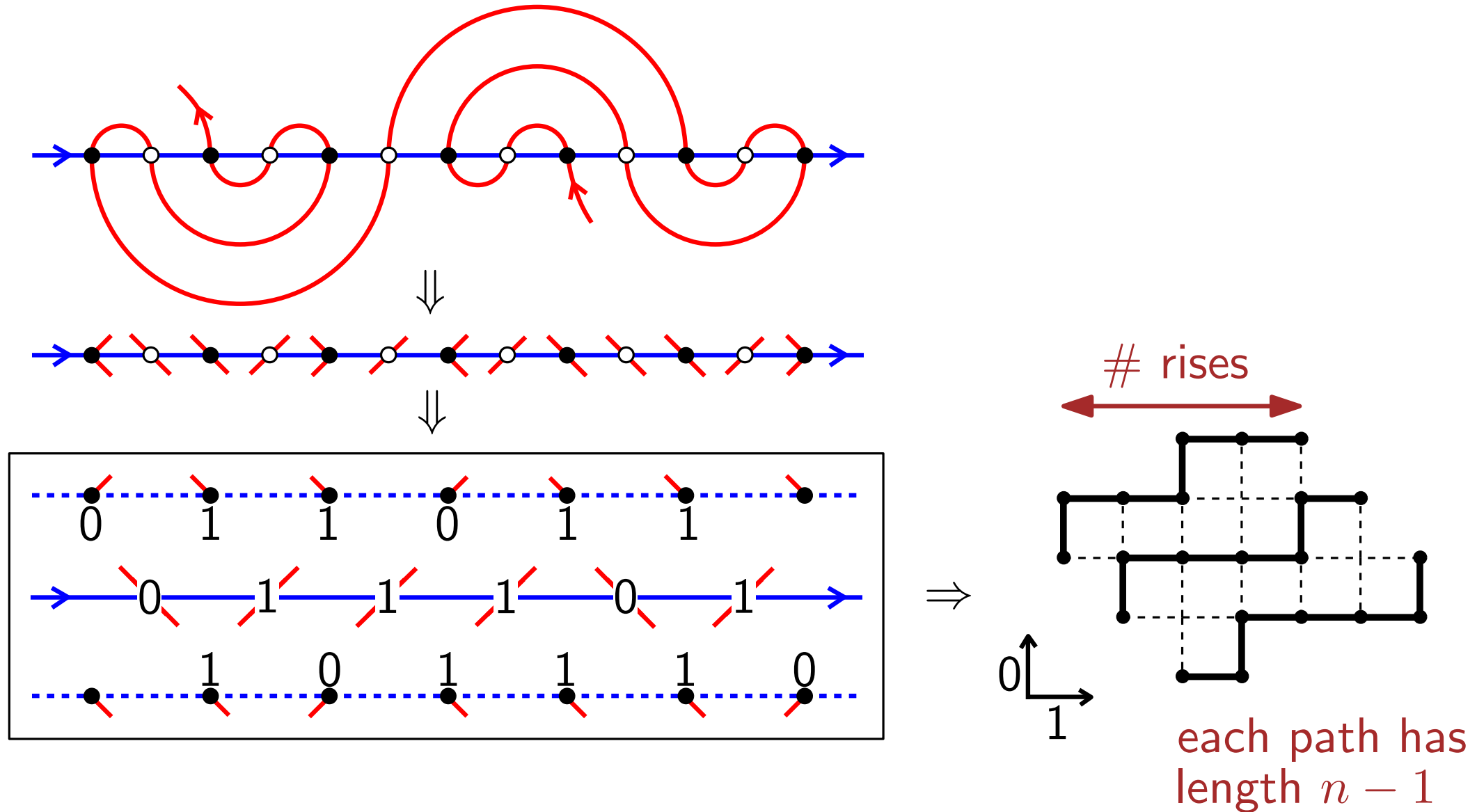

close to encoding in **[Viennot'81, Dulucq-Guibert'98]**

Encoding a monotone 2-line meander

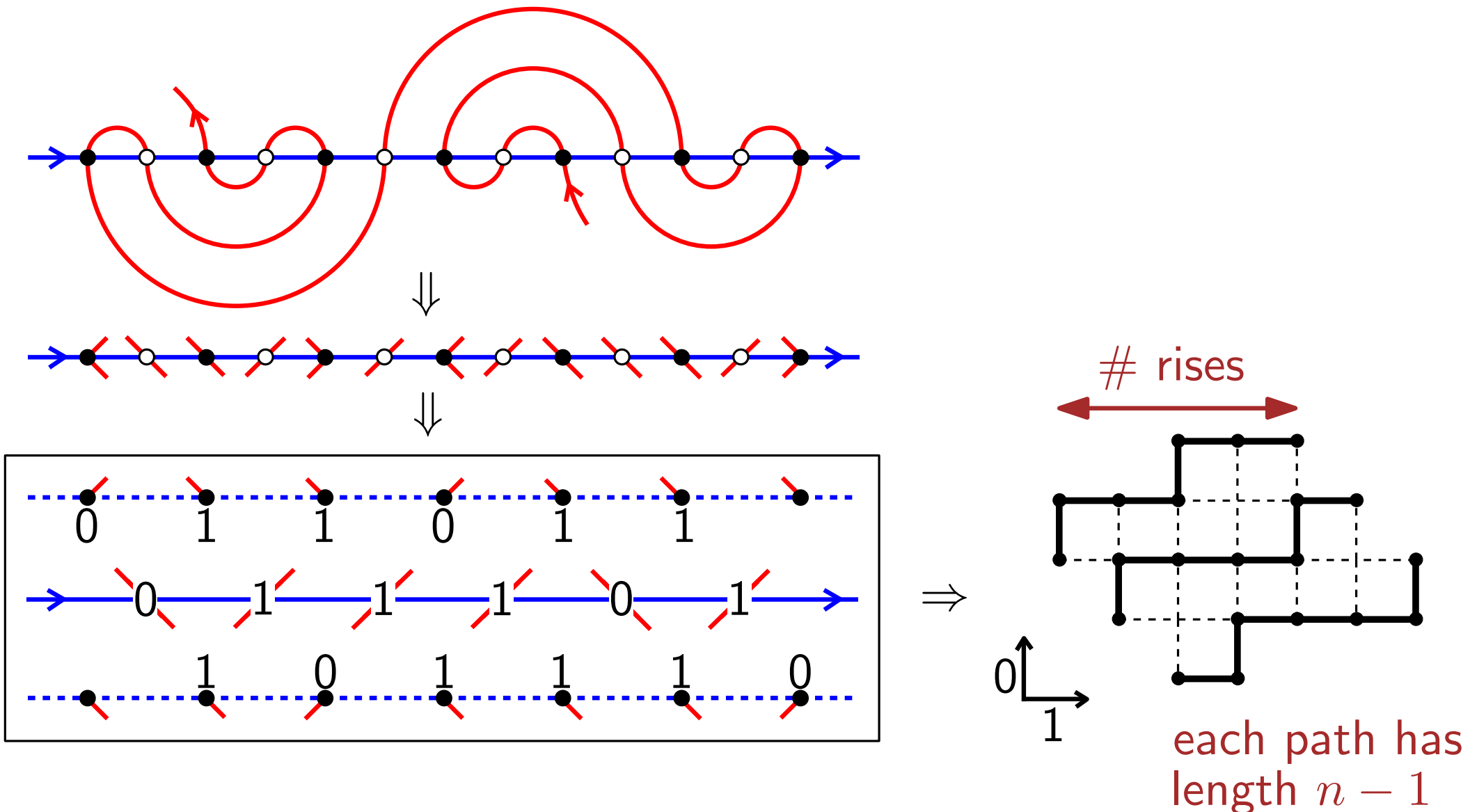

close to encoding in **[Viennot'81, Dulucq-Guibert'98]**
 exactly coincides with encoding in **[Felsner-F-Noy-Orden'11]**
 (uses "equatorial line" in separating decompositions of quadrangulations)

Enumeration using the LGV lemma

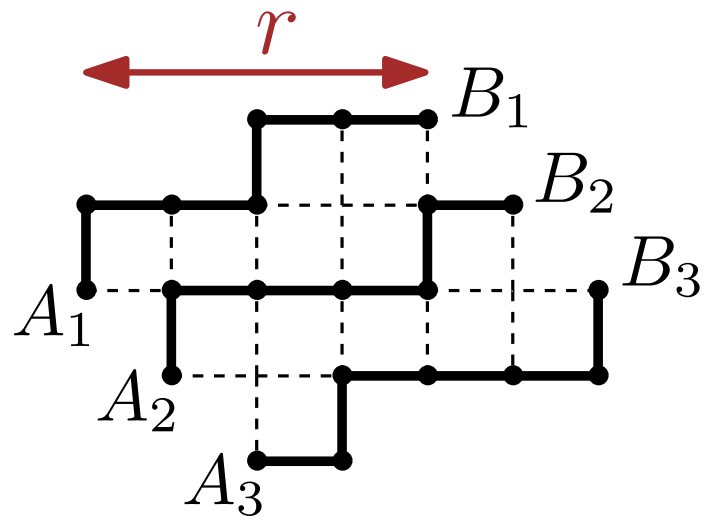

each path has
length $n - 1$

Enumeration using the LGV lemma

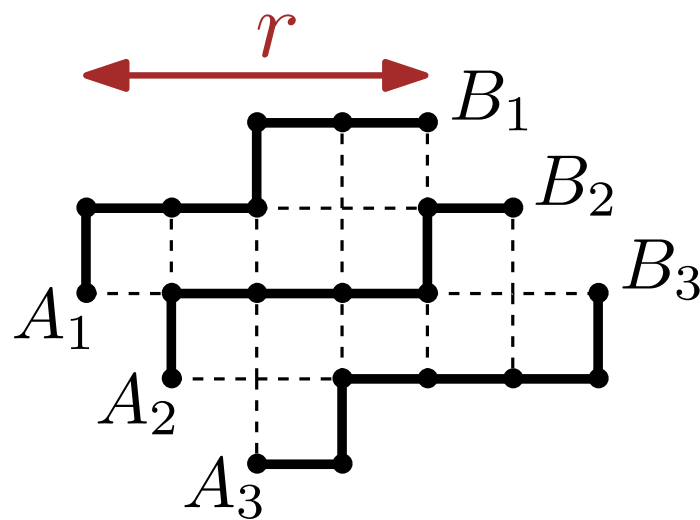

each path has length $n - 1$

Let $a_{i,j} = \#$ (upright lattice paths from A_i to B_j) $= \binom{n-1}{x(B_j) - x(A_i)}$

By the **Lindstroem-Gessel-Viennot Lemma** (used in **[Viennot'81]**)
the number $b_{n,r}$ of such nonintersecting triples of paths is

$$b_{n,r} = \text{Det}(a_{i,j}) = \begin{vmatrix} \binom{n-1}{r} & \binom{n-1}{r+1} & \binom{n-1}{r+2} \\ \binom{n-1}{r-1} & \binom{n-1}{r} & \binom{n-1}{r+1} \\ \binom{n-1}{r-2} & \binom{n-1}{r-1} & \binom{n-1}{r} \end{vmatrix} = \frac{2}{n(n+1)^2} \binom{n+1}{r} \binom{n+1}{r+1} \binom{n+1}{r+2}$$

Enumeration using the LGV lemma

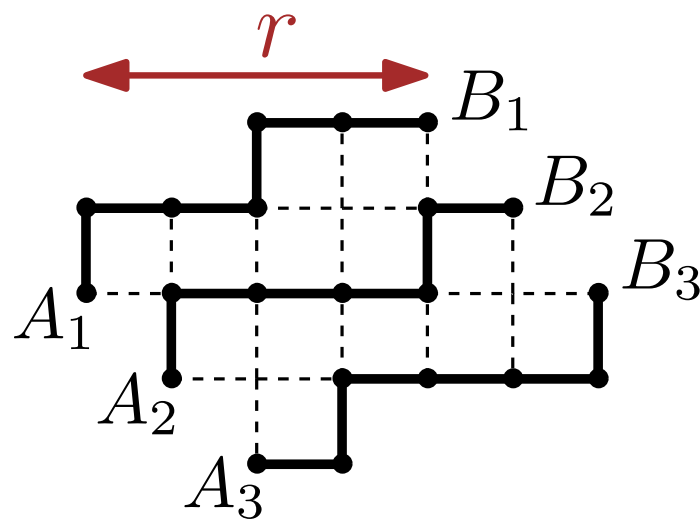

each path has length $n - 1$

Let $a_{i,j} = \#$ (upright lattice paths from A_i to B_j) $= \binom{n-1}{x(B_j) - x(A_i)}$

By the **Lindstroem-Gessel-Viennot Lemma** (used in **[Viennot'81]**)
the number $b_{n,r}$ of such nonintersecting triples of paths is

$$b_{n,r} = \text{Det}(a_{i,j}) = \begin{vmatrix} \binom{n-1}{r} & \binom{n-1}{r+1} & \binom{n-1}{r+2} \\ \binom{n-1}{r-1} & \binom{n-1}{r} & \binom{n-1}{r+1} \\ \binom{n-1}{r-2} & \binom{n-1}{r-1} & \binom{n-1}{r} \end{vmatrix} = \frac{2}{n(n+1)^2} \binom{n+1}{r} \binom{n+1}{r+1} \binom{n+1}{r+2}$$

this is also the number of Baxter permutations of size n with r rises

Alternating (reduced) Baxter permutations

[Cori-Dulucq-Viennot'86], [Dulucq-Guibert'98]

1) Case n even, $n = 2k$

$\pi = 8\ 9\ 7\ 10\ 1\ 4\ 3\ 5\ 2\ 6$

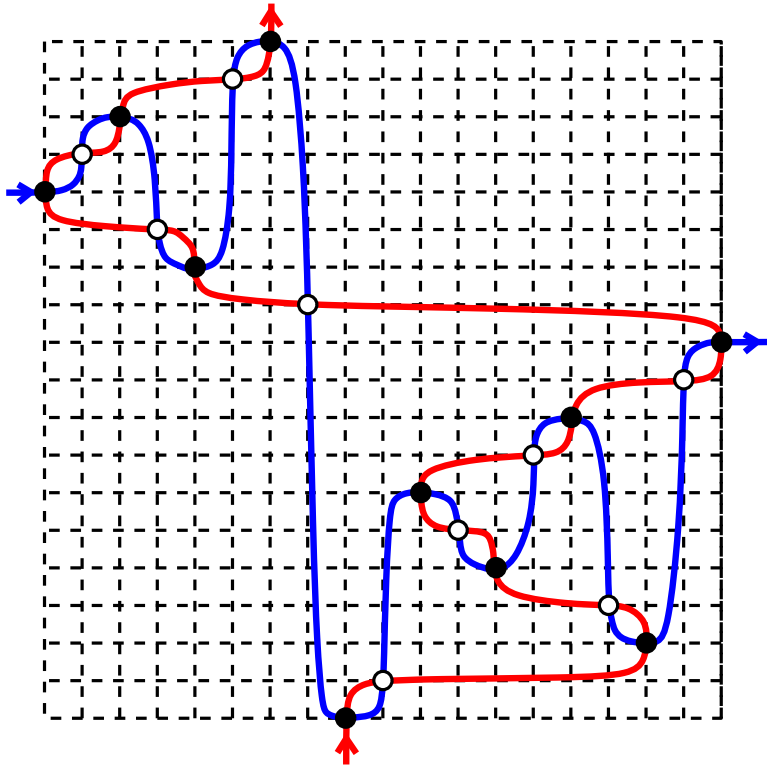

Alternating (reduced) Baxter permutations

[Cori-Dulucq-Viennot'86], [Dulucq-Guibert'98]

1) Case n even, $n = 2k$

$\pi = 8 \ 9 \ 7 \ 10 \ 1 \ 4 \ 3 \ 5 \ 2 \ 6$

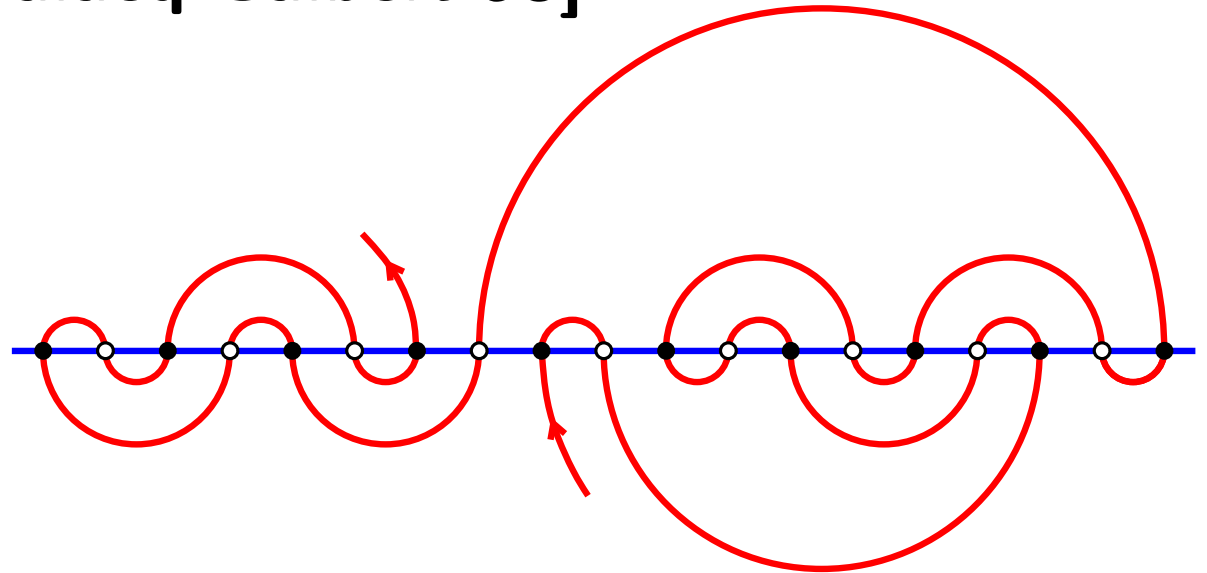
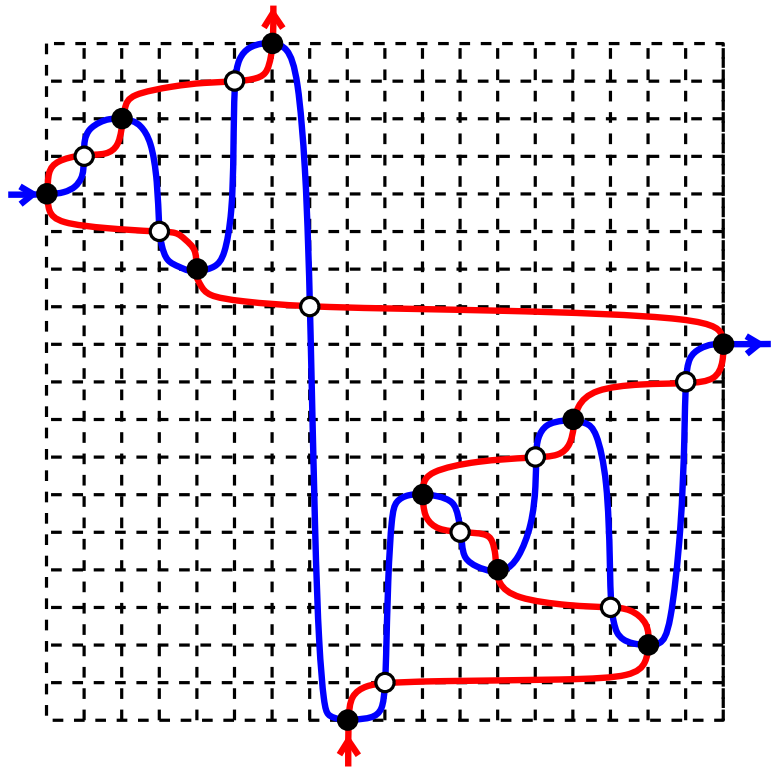

alternation \Rightarrow middle word is 010101...0

Doubly alternating (reduced) Baxter permutations

[Guibert-Linusson'00]

1) Case n even, $n = 2k$

$\pi = 5 \ 7 \ 6 \ 8 \ 3 \ 4 \ 1 \ 2$

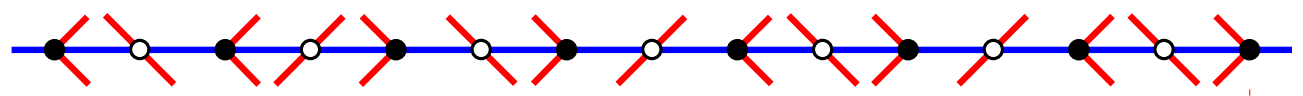
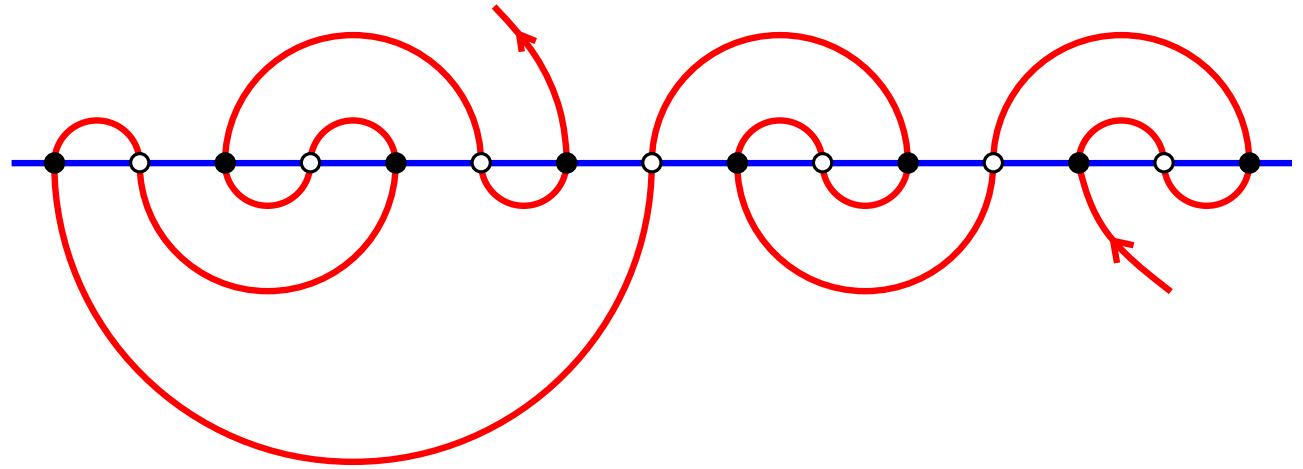
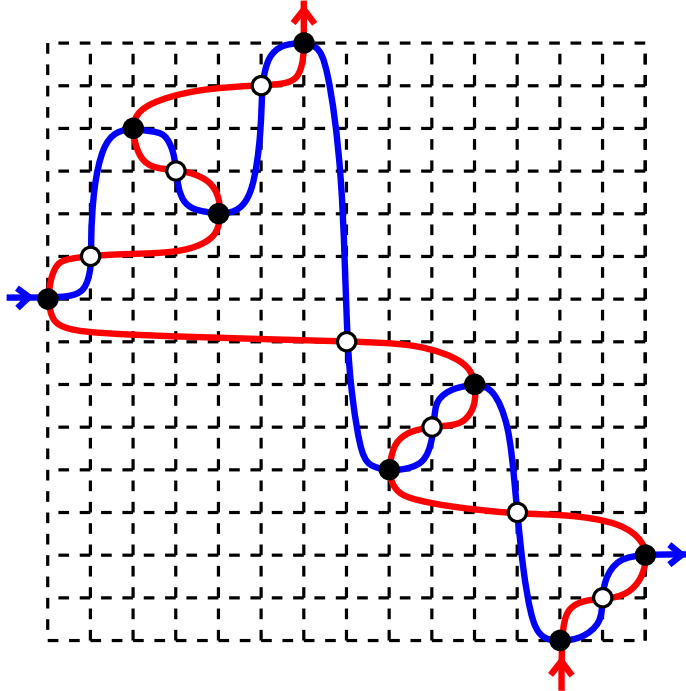

alternation of π : middle word is 010101...0

middle path is

alternation of π^{-1} : black points are or

Doubly alternating (reduced) Baxter permutations

[Guibert-Linusson'00]

1) Case n even, $n = 2k$

$\pi = 5 \ 7 \ 6 \ 8 \ 3 \ 4 \ 1 \ 2$

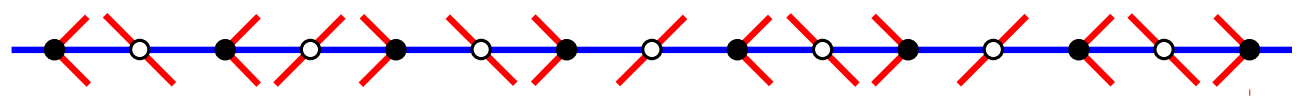
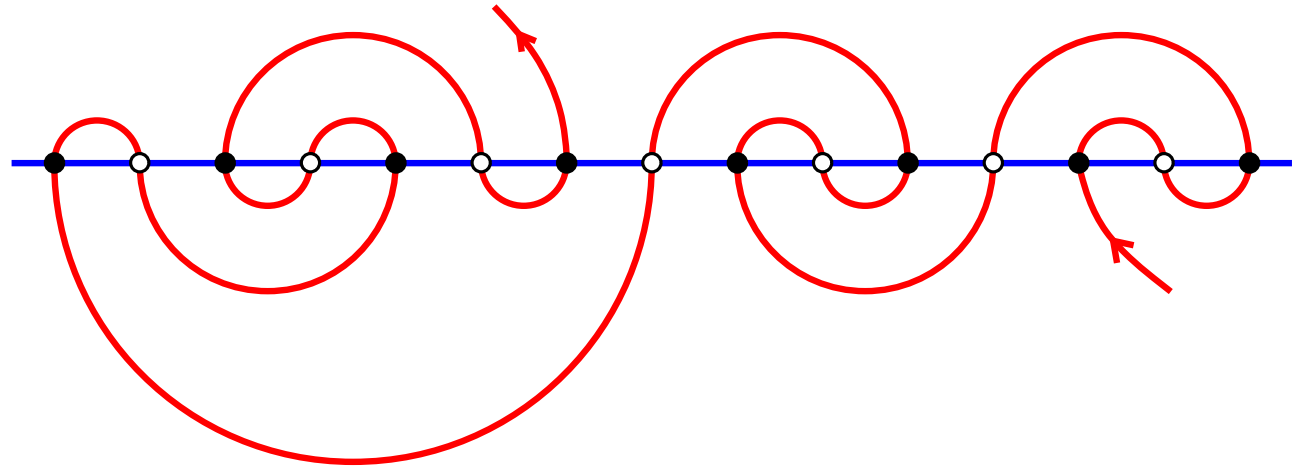
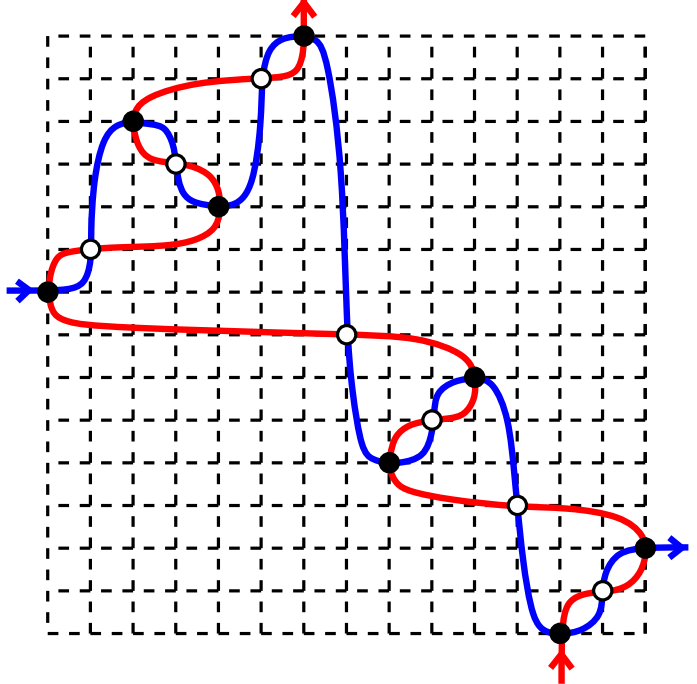

alternation of π : middle word is $010101 \dots 0$

middle path is

alternation of π^{-1} : black points are or

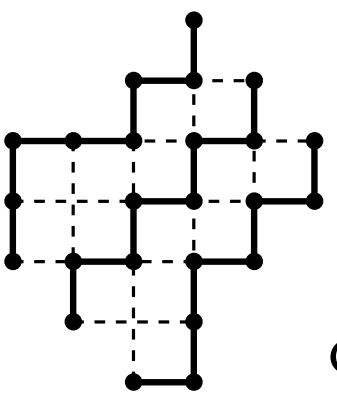

\Rightarrow
mirror
of each
other

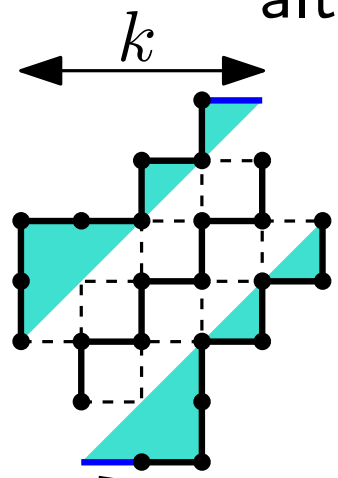

There are Cat_k doubly alternating (reduced) Baxter permutations of size n

Doubly alternating (reduced) Baxter permutations

[Guibert-Linusson'00]

2) Case n odd, $n = 2k + 1$

$\pi = 1 \ 3 \ 2 \ 5 \ 4 \ 9 \ 7 \ 8 \ 6$

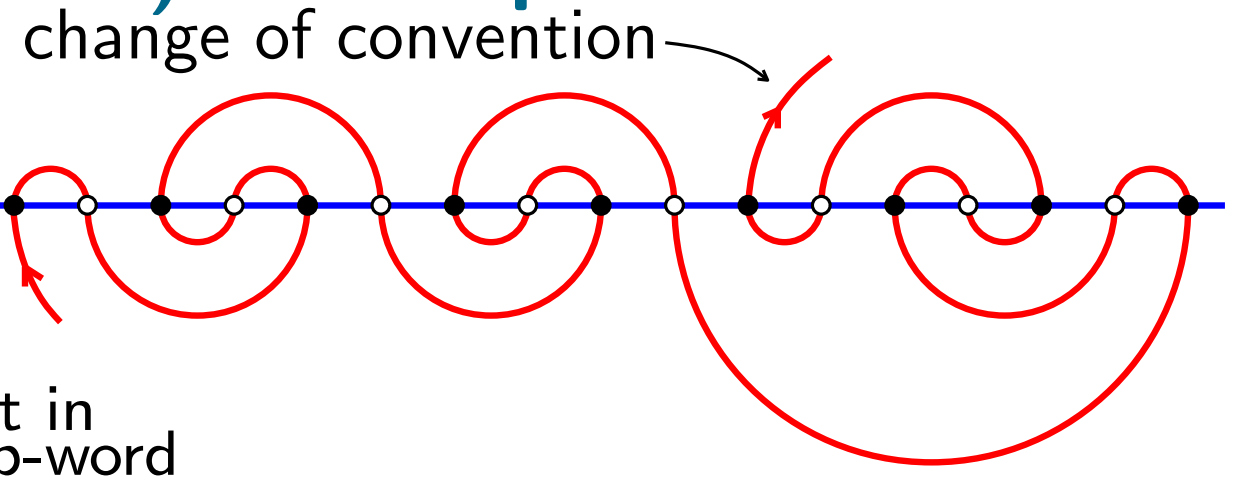
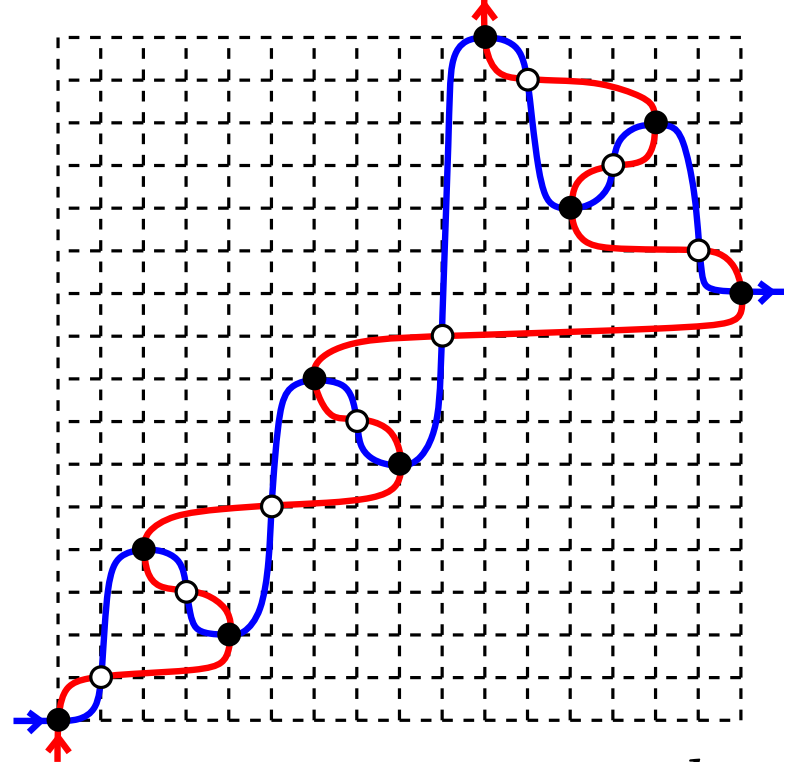

not in top-word

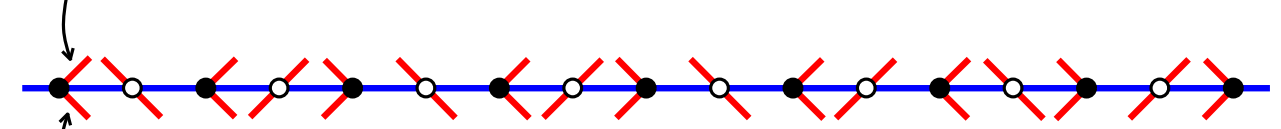

not in bottom-word

alternation of π : middle word is $010101 \dots 1$
 alternation of π^{-1} : black points are \blacktriangleleft or \blacktriangleright

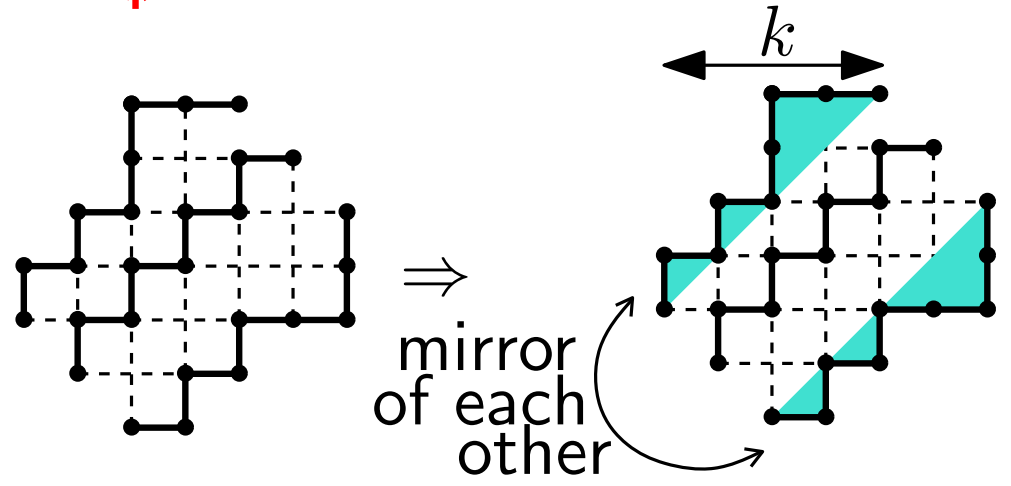

There are Cat_k doubly alternating (reduced) Baxter permutations of size n