

Presburger Counter Machines

Jérôme Leroux

LaBRI

December 6, 2012

Joint work with Sébastien Bardin, Bernard Boigelot, Rémi Bonnet, Florent Bouchy, Julien Brusten, Nicolas Caniart, Alain Finkel, Emmanuel Fleury, Thomas Gawlitza, Philippe Herrmann, Alexander Heußner, Daniel Kroening, Olivier Ly, Anca Muscholl, Laure Petrucci, Gérald Point, Igor Potapov, Jan Reineke, Philipp Rümmer, Philippe Schnoebelen, Helmut Seidl, Grégoire Sutre, Renaud Tabary, Aymeric Vincent, Reinhard Wilhelm, and Marc Zeitoun.

System



Model

$\models?$

Specification



Formula

\cap

Reachability

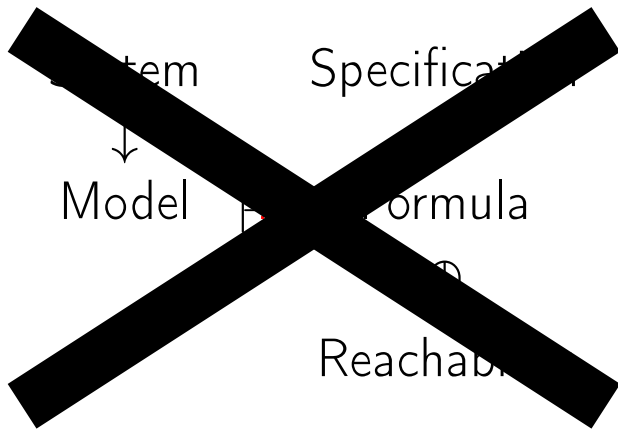

Reachability Problem

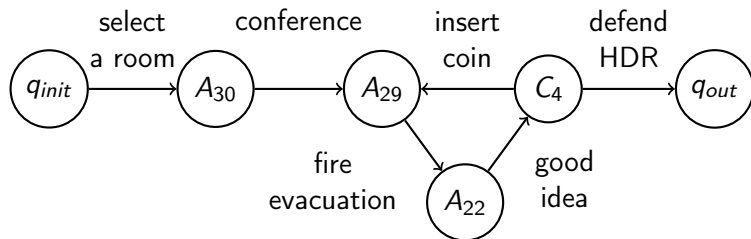

Reachability : Does there exist a run from q_{init} to q_{out} ?

Reachability Problem

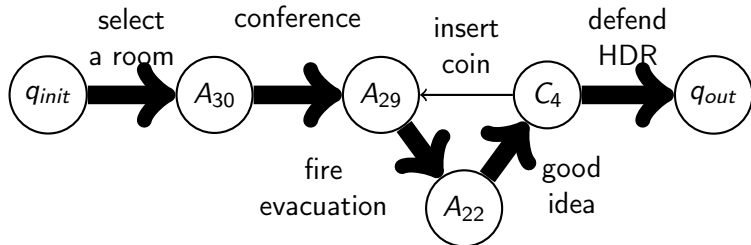

Reachability : Does there exist a run from q_{init} to q_{out} ?

- The reachability problem is decidable.
- Many approaches with termination guaranties:
 - ▶ Concrete explorations.
 - ▶ Symbolic explorations.
 - ▶ CEGAR approaches.
 - ▶ Bounded Model-Checking (SAT solvers).
 - ▶ Lazy interpolation.
 - ▶ Abstract interpretation.
- Efficient tools exist.

- The reachability problem is ~~decidable~~ undecidable in general.
- Many approaches ~~with~~ without termination guaranties:
 - ▶ Concrete explorations.
 - ▶ Symbolic explorations.
 - ▶ CEGAR approaches.
 - ▶ Bounded Model-Checking (~~SAT solvers~~) (SMT solvers).
 - ▶ Lazy interpolation.
 - ▶ Abstract interpretation.
- Efficient tools exist.

Presburger Arithmetic

Definition (Presburger Arithmetic)

$\text{FO}(\mathbb{N}, +)$.

Example: $\exists z \ x + z = y$ means $x \leq y$.

Theorem (Presburger 1929)

The Presburger arithmetic is decidable.

Presburger Counter Machines (PCM)

Definition (Presburger Counter Machine)

(Q, d, T) where:

- Q finite set of control states.
- $d \geq 1$ number of counters.
- T finite set of transitions (q, ϕ, q') with $q, q' \in Q$ and ϕ Presburger formula denoting $R_\phi \subseteq \mathbb{N}^d \times \mathbb{N}^d$.

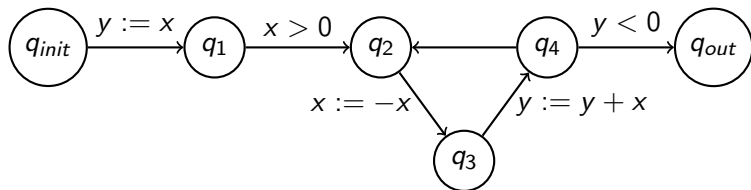

Presburger Counter Machines (PCM)

Definition (Presburger Counter Machine)

(Q, d, T) where:

- Q finite set of control states.
- $d \geq 1$ number of counters.
- T finite set of transitions (q, ϕ, q') with $q, q' \in Q$ and ϕ Presburger formula denoting $R_\phi \subseteq \mathbb{N}^d \times \mathbb{N}^d$.

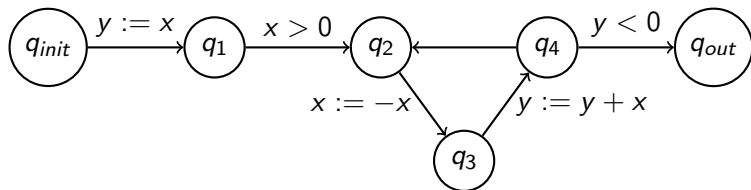

Theorem

The reachability problem is undecidable even with one counter.

Presburger Invariants

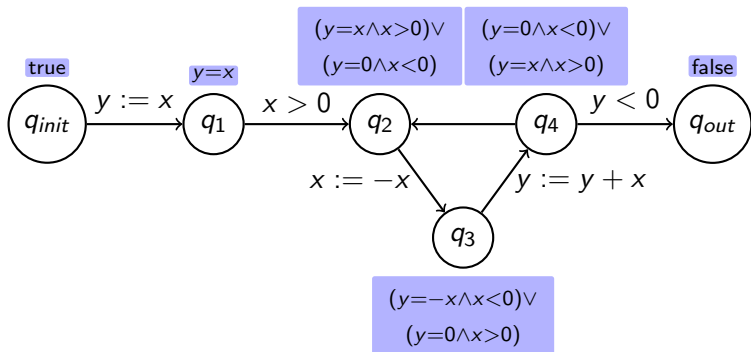

Presburger Invariants

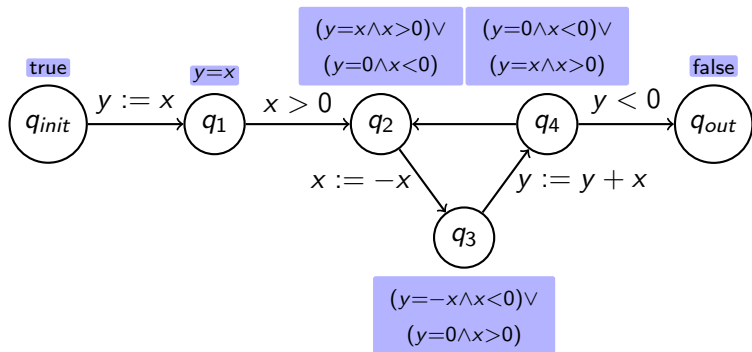

- Find classes of PCM with Presburger invariants.
- Efficient algorithms for computing Presburger invariants.

1 Presburger Arithmetic And Automata

- The satisfiability problem
- Representable by Automata
- Presburger Automata
- Cylindrical Spaces

2 Vector Addition System Reachability Problem

- Vector Addition Systems
- Almost Linear Sets
- Well Order Over The Runs

3 Research Projects

1 Presburger Arithmetic And Automata

- The satisfiability problem
- Representable by Automata
- Presburger Automata
- Cylindrical Spaces

2 Vector Addition System Reachability Problem

- Vector Addition Systems
- Almost Linear Sets
- Well Order Over The Runs

3 Research Projects

1 Presburger Arithmetic And Automata

- The satisfiability problem
- Representable by Automata
- Presburger Automata
- Cylindrical Spaces

2 Vector Addition System Reachability Problem

- Vector Addition Systems
- Almost Linear Sets
- Well Order Over The Runs

3 Research Projects

Quantifier Elimination

$$\text{FO}(\mathbb{N}, +)$$

same expressive power as

$$\text{FO}(\mathbb{N}, +, 0, 1, \leq, (\sim_m)_{m \in \mathbb{N}_{>0}})$$

where $x \sim_m y$ if m divides $x - y$.

Quantifier Elimination

$$\text{FO}(\mathbb{N}, +)$$

same expressive power as

$$\text{FO}(\mathbb{N}, +, \mathbf{0}, \mathbf{1}, \leq, (\sim_m)_{m \in \mathbb{N}_{>0}})$$

where $x \sim_m y$ if m divides $x - y$.

Theorem (Presburger 1929)

There exists a quantifier elimination algorithm for:

$$\text{FO}(\mathbb{N}, +, \mathbf{0}, \mathbf{1}, \leq, (\sim_m)_{m \in \mathbb{N}_{>0}})$$

Computation can be performed in 3-EXPTIME [Oppen 1978]

$$\{(x_1, x_2, x_3) \in \mathbb{N}^3 \mid x_1 + x_2 = x_3\}$$

Automata

$$\{(x_1, x_2, x_3) \in \mathbb{N}^3 \mid x_1 + x_2 = x_3\}$$

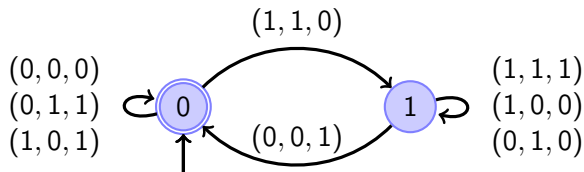

$$\{(x_1, x_2, x_3) \in \mathbb{N}^3 \mid x_1 + x_2 = x_3\}$$

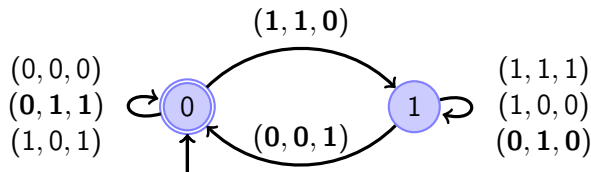

$$(2, 7, 9) = 2^0(0, 1, 1) + 2^1(1, 1, 0) + 2^2(0, 1, 0) + 2^3(0, 0, 1)$$

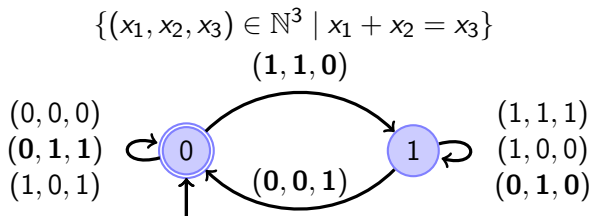

$$(2, 7, 9) = 2^0(0, 1, 1) + 2^1(1, 1, 0) + 2^2(0, 1, 0) + 2^3(0, 0, 1)$$

Theorem (Klaedtke 2004, Durand-Gasselin and Habermehl 2010)

INPUT : $\mathbf{X} \subseteq \mathbb{N}^d$ denoted by ϕ in $\text{FO}(\mathbb{N}, +)$

OUTPUT : The minimal deterministic automaton representing \mathbf{X} .

Computation in 3-EXPTIME

Finite Models

$\exists c > 0$ such that for every quantifier free formula ϕ in $\text{FO}(\mathbb{N}, +)$:

$$\exists x_1 \forall y_1 \cdots \exists x_n \forall y_n \phi \quad \text{SAT}$$

$$\iff$$

$$\exists x_1 \leq k \quad \forall y_1 \leq k \quad \cdots \quad \exists x_n \leq k \quad \forall y_n \leq k \quad \phi \quad \text{SAT}$$

where $k = 2^{2^{c|\phi|}}$.

Finite Models

$\exists c > 0$ such that for every quantifier free formula ϕ in $\text{FO}(\mathbb{N}, +)$:

$$\exists x_1 \forall y_1 \cdots \exists x_n \forall y_n \phi \quad \text{SAT}$$

$$\iff$$

$$\exists x_1 \leq k \quad \forall y_1 \leq k \quad \cdots \quad \exists x_n \leq k \quad \forall y_n \leq k \quad \phi \quad \text{SAT}$$

where $k = 2^{2^{c|\phi|}}$.

Theorem (Berman 1977)

The satisfiability of $\text{FO}(\mathbb{N}, +)$ is complete for the class of problems decidable with alternating Turing machines:

- *working in time $2^{2^{O(n)}}$,*
- *with at most $O(n)$ alternations.*

Complexity between 2-EXPSpace and 3-EXPTIME.

Sum Up

Quantifier Elimination	Finite Model	Automata
3-EXPTIME	$\text{ATIME}(O(n), 2^{2^{O(n)}})$	3-EXPTIME

Complexities are tight.

1 Presburger Arithmetic And Automata

- The satisfiability problem
- **Representable by Automata**
- Presburger Automata
- Cylindrical Spaces

2 Vector Addition System Reachability Problem

- Vector Addition Systems
- Almost Linear Sets
- Well Order Over The Runs

3 Research Projects

Theorem (Bruyère, Hansel, Michaux, and Villemaire 1994)

Representable by automata



Definable in $\text{FO}(\mathbb{N}, +, V_2)$

where $V_2(x) = 2^n$ such that 2^n divides x but 2^{n+1} does not divide x .

Automata for FO ($\mathbb{N}, +, V_2$) non-elementary [Blumensath 2000]

Automata for FO ($\mathbb{N}, +$) 3-exponential

1 Presburger Arithmetic And Automata

- The satisfiability problem
- Representable by Automata
- **Presburger Automata**
- Cylindrical Spaces

2 Vector Addition System Reachability Problem

- Vector Addition Systems
- Almost Linear Sets
- Well Order Over The Runs

3 Research Projects

Membership Problem

Presburger Membership Problem:

INPUT : An automaton representing $X \subseteq \mathbb{N}^d$

OUTPUT : X is definable in FO $(\mathbb{N}, +)$.

- 4-EXPTIME upper-bound by Muchnik in 1991.
- Allouche and Shallit in 2003 conjectured PTIME for $d = 1$.
- Latour in 2004 in EXPTIME for the convex sets.
- Lugiez in 2004 in 2-EXPTIME for the semi-convex sets.

Membership Problem

Presburger Membership Problem:

INPUT : An automaton representing $X \subseteq \mathbb{N}^d$

OUTPUT : X is definable in FO $(\mathbb{N}, +)$.

- 4-EXPTIME upper-bound by Muchnik in 1991.
- Allouche and Shallit in 2003 conjectured PTIME for $d = 1$.
- Latour in 2004 in EXPTIME for the convex sets.
- Lugiez in 2004 in 2-EXPTIME for the semi-convex sets.

Theorem (Leroux 2005)

The Presburger Membership Problem is in PTIME.

Moreover, a Presburger formula denoting X is computable in PTIME.

Normalization For The Presburger Arithmetic

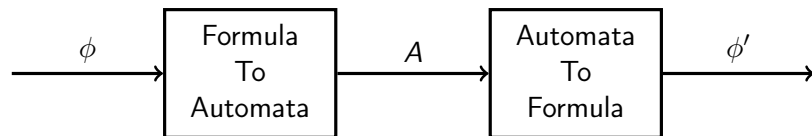

$$\phi \sim \phi'$$

$$\phi_1 \sim \phi_2 \implies \phi'_1 = \phi'_2$$

Tool TaPAS [Bardin, Leroux and Point 2006 and 2009]:

- Implements all the previously given algorithms.
- Based on shared automata [Couvreur 2004].
- Most efficient tool on large benchmarks compared to MONA, LIRA, and LASH.
- Open source.

1 Presburger Arithmetic And Automata

- The satisfiability problem
- Representable by Automata
- Presburger Automata
- Cylindrical Spaces

2 Vector Addition System Reachability Problem

- Vector Addition Systems
- Almost Linear Sets
- Well Order Over The Runs

3 Research Projects

Cylindrical Spaces

Definition (Cylindrical space)

$\mathbf{H} = \mathbf{B} + \mathbf{V}$ where:

- $\mathbf{B} \subseteq \mathbb{Q}^d$ non-empty bounded set,
- $\mathbf{V} = \mathbb{Q}\mathbf{v}_1 + \dots + \mathbb{Q}\mathbf{v}_n$ vector space where $\mathbf{v}_j \in \mathbb{Q}^d$.

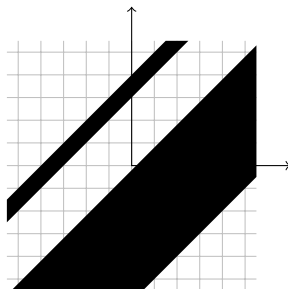
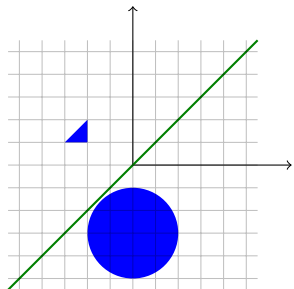

Cylindrical Hull

Definition (Cylindrical hull)

Let $X \subseteq \mathbb{Q}^d$.

$\text{chull}(X)$ minimal for \subseteq :

$$\bigcup_{\text{finite}} \text{cylindrical spaces} \supseteq X$$

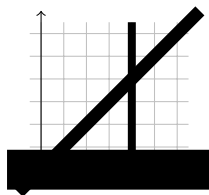
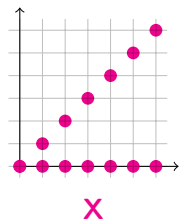

Not minimal

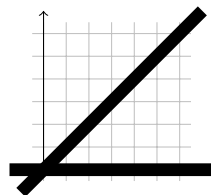

Minimal

Cylindrical Hull Direction Problem

Cylindrical Hull Direction Problem:

INPUT : $X \subseteq \mathbb{N}^d$ represented by an automaton.

OUTPUT : Vector spaces $V_1, \dots, V_k \subseteq \mathbb{Q}^d$ such that:

$$\text{chull}(X) = (B_1 + V_1) \cup \dots \cup (B_k + V_k)$$

for some non-empty bounded sets $B_1, \dots, B_k \subseteq \mathbb{Q}^d$.

Cylindrical Hull Direction Problem

Cylindrical Hull Direction Problem:

INPUT : $X \subseteq \mathbb{N}^d$ represented by an automaton.

OUTPUT : Vector spaces $V_1, \dots, V_k \subseteq \mathbb{Q}^d$ such that:

$$\text{chull}(X) = (B_1 + V_1) \cup \dots \cup (B_k + V_k)$$

for some non-empty bounded sets $B_1, \dots, B_k \subseteq \mathbb{Q}^d$.

Theorem (Leroux 2003)

The Cylindrical Hull Direction Problem is in PTIME.

Interference Principle

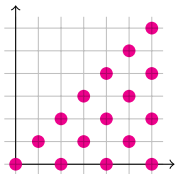

X

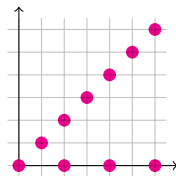

X \setminus ((3,1) + X)

- 1 Presburger Arithmetic And Automata
 - The satisfiability problem
 - Representable by Automata
 - Presburger Automata
 - Cylindrical Spaces
- 2 Vector Addition System Reachability Problem
 - Vector Addition Systems
 - Almost Linear Sets
 - Well Order Over The Runs
- 3 Research Projects

- 1 Presburger Arithmetic And Automata
 - The satisfiability problem
 - Representable by Automata
 - Presburger Automata
 - Cylindrical Spaces
- 2 Vector Addition System Reachability Problem
 - Vector Addition Systems
 - Almost Linear Sets
 - Well Order Over The Runs
- 3 Research Projects

The Hopcroft and Pansiot 1979 Example

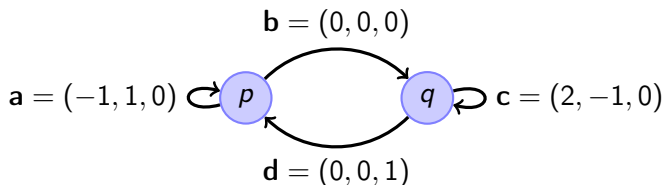

$$(p, 1, 0, 0) \xrightarrow{\mathbf{a}} (p, 0, 1, 0) \xrightarrow{\mathbf{b}} (q, 0, 1, 0) \xrightarrow{\mathbf{c}} (q, 2, 0, 0) \xrightarrow{\mathbf{d}} (p, 2, 0, 0)$$

The Hopcroft and Pansiot 1979 Example

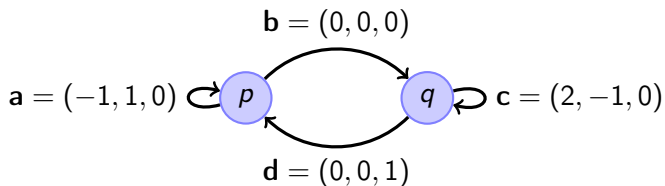

$$(p, 1, 0, 0) \xrightarrow{\mathbf{a}} (p, 0, 1, 0) \xrightarrow{\mathbf{b}} (q, 0, 1, 0) \xrightarrow{\mathbf{c}} (q, 2, 0, 0) \xrightarrow{\mathbf{d}} (p, 2, 0, 0)$$

$$(p, 1, 0, 0) \xrightarrow{\mathbf{a}^{2^0} \mathbf{b} \mathbf{c}^{2^0} \mathbf{d} \dots \mathbf{a}^{2^n} \mathbf{b} \mathbf{c}^{2^n} \mathbf{d}} (p, 2^{n+1}, 0, n)$$

The Hopcroft and Pansiot 1979 Example

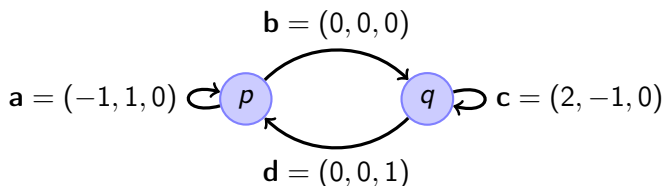

$$(p, 1, 0, 0) \xrightarrow{\mathbf{a}} (p, 0, 1, 0) \xrightarrow{\mathbf{b}} (q, 0, 1, 0) \xrightarrow{\mathbf{c}} (q, 2, 0, 0) \xrightarrow{\mathbf{d}} (p, 2, 0, 0)$$

$$(p, 1, 0, 0) \xrightarrow{\mathbf{a}^{2^0} \mathbf{b} \mathbf{c}^{2^0} \mathbf{d} \dots \mathbf{a}^{2^n} \mathbf{b} \mathbf{c}^{2^n} \mathbf{d}} (p, 2^{n+1}, 0, n)$$

Configurations reachable from $(p, 1, 0, 0)$:

$$\{(p, x, y, z) \mid 1 \leq x + y \leq 2^z\} \cup \{(q, x, y, z) \mid 1 \leq x + 2y \leq 2^{z+1}\}$$

Vector Addition Systems

Definition (Vector Addition System)

Finite set $\mathbf{A} \subseteq \mathbb{Z}^d$.

Action $\mathbf{a} \in \mathbf{A}$.

Configuration $\mathbf{c} \in \mathbb{N}^d$.

Transition relation $\mathbf{c} \xrightarrow{\mathbf{a}} \mathbf{c}'$ if $\mathbf{c}' = \mathbf{c} + \mathbf{a}$.

Vector Addition Systems

Definition (Vector Addition System)

Finite set $\mathbf{A} \subseteq \mathbb{Z}^d$.

Action $\mathbf{a} \in \mathbf{A}$.

Configuration $\mathbf{c} \in \mathbb{N}^d$.

Transition relation $\mathbf{c} \xrightarrow{\mathbf{a}} \mathbf{c}'$ if $\mathbf{c}' = \mathbf{c} + \mathbf{a}$.

Theorem

The reachability problem is decidable [Mayr 1981, Kosaraju 1982].

- 1 Presburger Arithmetic And Automata
 - The satisfiability problem
 - Representable by Automata
 - Presburger Automata
 - Cylindrical Spaces
- 2 **Vector Addition System Reachability Problem**
 - Vector Addition Systems
 - **Almost Linear Sets**
 - Well Order Over The Runs
- 3 Research Projects

Linear Sets

Definition (Linear Sets)

$L = \mathbf{b} + \mathbb{N}\mathbf{p}_1 + \cdots + \mathbb{N}\mathbf{p}_k$ where:

- $\mathbf{b} \in \mathbb{N}^d$ basis.
- $\mathbf{p}_1, \dots, \mathbf{p}_k \in \mathbb{N}^d$ periods.

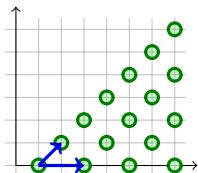

$$\mathbf{b} = (1, 0)$$

$$\mathbf{p}_1 = (1, 1) \text{ and } \mathbf{p}_2 = (2, 0)$$

Linear Sets

Definition (Linear Sets)

$L = \mathbf{b} + \mathbb{N}\mathbf{p}_1 + \dots + \mathbb{N}\mathbf{p}_k$ where:

- $\mathbf{b} \in \mathbb{N}^d$ basis.
- $\mathbf{p}_1, \dots, \mathbf{p}_k \in \mathbb{N}^d$ periods.

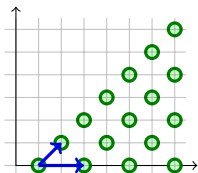

$$\mathbf{b} = (1, 0)$$

$$\mathbf{p}_1 = (1, 1) \text{ and } \mathbf{p}_2 = (2, 0)$$

Theorem (Ginsburg and Spanier 1966)

$$\text{Presburger sets} = \bigcup_{\text{finite}} \text{linear sets}$$

Almost Linear Sets

Definition (Almost linear sets)

$\mathbf{b} + \mathbf{P}$ where $\mathbf{b} \in \mathbb{N}^d$ basis and $\mathbf{P} \subseteq \mathbb{N}^d$ satisfies:

- $\mathbf{0} \in \mathbf{P}$,
- $\mathbf{P} + \mathbf{P} \subseteq \mathbf{P}$, and
- $\mathbb{Q}_{\geq 0}\mathbf{P}$ is definable in $\text{FO}(\mathbb{Q}_{\geq 0}, +)$.

Example

$$\mathbf{P} = \{(p_1, p_2) \in \mathbb{N}^2 \mid p_2 \leq p_1 \wedge p_1 \leq 2p_2 - 1\}.$$

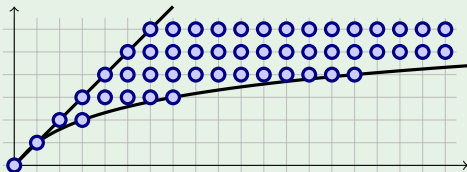

Example

$$\{(p, x, y, z) \mid 1 \leq x + y \leq 2^z\} \cup \{(q, x, y, z) \mid 1 \leq x + 2y \leq 2^{z+1}\}$$
$$=$$
$$\bigcup_{\text{finite}} \text{almost linear sets}$$

- 1 Presburger Arithmetic And Automata
 - The satisfiability problem
 - Representable by Automata
 - Presburger Automata
 - Cylindrical Spaces
- 2 Vector Addition System Reachability Problem
 - Vector Addition Systems
 - Almost Linear Sets
 - Well Order Over The Runs
- 3 Research Projects

Run

$$\mathbf{A} = \left\{ \begin{array}{c} \nearrow \\ \searrow \end{array} \right\}$$

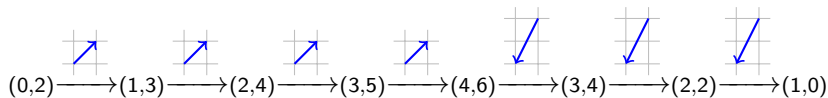
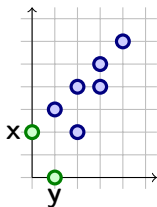

Definition (Well Order)

Order (S, \sqsubseteq) s.t. $\forall s_0, s_1, \dots \in S$
 $\exists n_0 < n_1 < \dots$ s.t. $s_{n_0} \sqsubseteq s_{n_1} \sqsubseteq \dots$

(\mathbb{N}, \leq) well order

(\mathbb{Z}, \leq) not well order: $-1, -2, -3, \dots$

$(S, =)$ well order $\iff S$ finite

Well Order Over The Runs

Definition

$$c_0 \xrightarrow{a_1} c_1 \cdots \xrightarrow{a_k} c_k \trianglelefteq \rho_0 \xrightarrow{a_1} \rho_1 \cdots \xrightarrow{a_k} \rho_k$$

if ρ_j run $c_j + \mathbb{N}^d \xrightarrow{*} c_j + \mathbb{N}^d$ for every j .

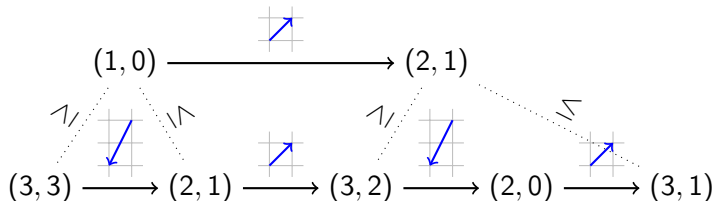

Theorem (Jančar 1990)

\trianglelefteq is a well order over the runs.

Reachability Sets Decomposition

Theorem (Leroux 2009)

Reachability sets of VAS are finite unions of almost linear sets.

Theorem (Leroux 2009)

¬ $x \xrightarrow{*} y$ implies there exists a Presburger set \mathbf{X} such that:

- $x \in \mathbf{X}$,
- $\text{Post}(\mathbf{X}, \mathbf{A}) \subseteq \mathbf{X}$ invariant, and
- $y \notin \mathbf{X}$.

Simple Algorithm

```
1 Reachability (  $x$  ,  $\mathbf{A}$  ,  $y$  )
2    $k \leftarrow 0$ 
3   repeat forever
4     for each word  $\sigma \in \mathbf{A}^k$ 
5       if  $x \xrightarrow{\sigma} y$ 
6         return “reachable”
7     for each Presburger formula of length  $k$  denoting  $\mathbf{X} \subseteq \mathbb{N}^d$ 
8       if  $x \in \mathbf{X}$ ,  $\text{Post}(\mathbf{X}, \mathbf{A}) \subseteq \mathbf{X}$ , and  $y \notin \mathbf{X}$ 
9         return “unreachable”
10     $k \leftarrow k + 1$ 
```

Complexity Gap

- The reachability problem is EXPSPACE-hard [Cardoza, Lipton and Meyer 1976].
- No elementary upper bounds are known.

Open problems:

- Minimal length of a run.
- Minimal size of a formula denoting an inductive invariant.
- Complexity
- Efficient algorithms in practice.

- 1 Presburger Arithmetic And Automata
 - The satisfiability problem
 - Representable by Automata
 - Presburger Automata
 - Cylindrical Spaces
- 2 Vector Addition System Reachability Problem
 - Vector Addition Systems
 - Almost Linear Sets
 - Well Order Over The Runs
- 3 Research Projects

Definition (Flat)

$\text{Post}(\mathbf{x}, \mathbf{A}^*)$ is flat if $\text{Post}(\mathbf{x}, \mathbf{A}^*) = \text{Post}(\mathbf{x}, w_1^* \dots w_k^*)$ where:

- $\mathbf{x} \in \mathbb{N}^d$ initial configuration.
- $w_1, \dots, w_k \in \mathbf{A}^*$.

Definition (Flat)

$\text{Post}(\mathbf{x}, \mathbf{A}^*)$ is flat if $\text{Post}(\mathbf{x}, \mathbf{A}^*) = \text{Post}(\mathbf{x}, w_1^* \dots w_k^*)$ where:

- $\mathbf{x} \in \mathbb{N}^d$ initial configuration.
- $w_1, \dots, w_k \in \mathbf{A}^*$.

With the coauthors Bardin, Finkel, Petrucci, Point, Schnoebelen, Sutre:

- Flat reachability sets are computable.
- Implemented in the tool FAST.
- All subclasses of VAS with known Presburger reachability sets have flat reachability sets.

Definition (Flat)

$\text{Post}(\mathbf{x}, \mathbf{A}^*)$ is flat if $\text{Post}(\mathbf{x}, \mathbf{A}^*) = \text{Post}(\mathbf{x}, w_1^* \dots w_k^*)$ where:

- $\mathbf{x} \in \mathbb{N}^d$ initial configuration.
- $w_1, \dots, w_k \in \mathbf{A}^*$.

With the coauthors Bardin, Finkel, Petrucci, Point, Schnoebelen, Sutre:

- Flat reachability sets are computable.
- Implemented in the tool FAST.
- All subclasses of VAS with known Presburger reachability sets have flat reachability sets.

Conjecture:

A reachability set is flat if and only if it is Presburger.

Complete CEGAR For VAS

Research Project 2/4

Project:

Improve acceleration techniques with over-approximations.
Refine approximations on-demand.

Complete CEGAR For VAS

Research Project 2/4

Project:

Improve acceleration techniques with over-approximations.
Refine approximations on-demand.

Lemma

Assume $\exists n_0 \leq n_1 \leq \dots$ in \mathbb{N} unbounded such that:

$$c \xrightarrow{w_1 \sigma_1^{n_0} \dots w_k \sigma_k^{n_0} \quad w_1 \sigma_1^{n_1} \dots w_k \sigma_k^{n_1} \dots}$$

Then $\exists \alpha > 0$ such that $\forall n \geq 0$:

$$c \xrightarrow{*} c + [\alpha \log(1+n)] \Delta(w_1 \dots w_k) + n \Delta(\sigma_1 \dots \sigma_k)$$

where $\Delta(\mathbf{a}_1 \dots \mathbf{a}_p) = \mathbf{a}_1 + \dots + \mathbf{a}_p$ displacement.

$x \xrightarrow{L} y$? with L context-free

- For some classes of L , the problem is equivalent to the reachability problem for VAS with zero tests [Atig and Ganty 2011].
- Ackermann-hard problem [Lazic 2012]

$x \xrightarrow{L} y$? with L context-free

- For some classes of L , the problem is equivalent to the reachability problem for VAS with zero tests [Atig and Ganty 2011].
- Ackermann-hard problem [Lazic 2012]

Conjecture:

Let $G = (\mathcal{N}, S, \mathbf{A}, T)$ be a context-free grammar where $\mathbf{A} \subseteq \mathbb{Z}^d$.

$\neg x \xrightarrow{L(G)} y$ iff there exists $(R_N)_{N \in \mathcal{N}}$ with $R_N \subseteq (\mathbb{N}^d)^2$ Presburger such that $(x, y) \notin R_S$, and

$$(N \leftarrow V_1 \dots V_k) \in T$$

implies $R_{V_1} \circ \dots \circ R_{V_k} \subseteq R_N$ where R_a is \xrightarrow{a} .

Hybrid Symbolic Representations

Research Project 4/4

Project:

Represent SCC of automata with formulas.

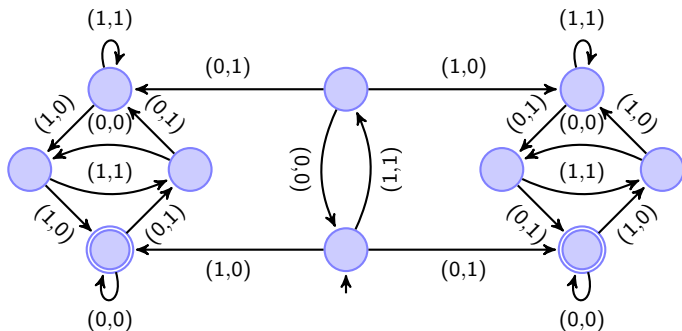

$$1 + 4x_2 = x_1 \quad \vee \quad 1 + 4x_1 = x_2$$

Hybrid Symbolic Representations

Research Project 4/4

Project:

Represent SCC of automata with formulas.

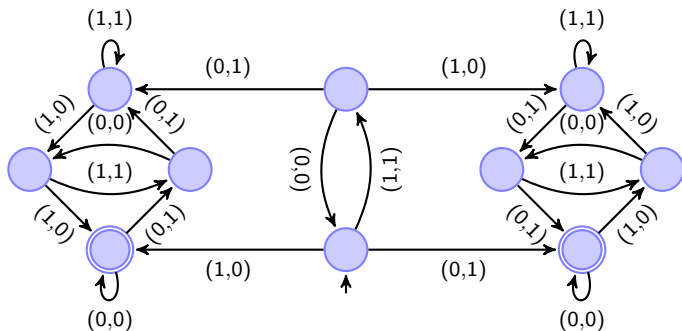

$$1 + 4x_2 = x_1 \quad \vee \quad 1 + 4x_1 = x_2$$
$$\left(-\frac{1}{3}, -\frac{1}{3}\right) = 2^0(1,1) + 2^1(0,0) + 2^2(1,1) + 2^3(0,0) + \dots$$

- Main theoretical tools:
 - ▶ Geometrical approach : linear sets, almost linear sets, conic sets, vector spaces, cylindrical spaces.
 - ▶ Well-orders : Dickson, Higman, and Kruskal's lemma.
 - ▶ Logic : $\text{FO}(\mathbb{N}, +)$ and $\text{FO}(\mathbb{Q}_{\geq 0}, +)$.
- Main results:
 - ▶ Reachability problem for VAS decidable with $\text{FO}(\mathbb{N}, +)$.
 - ▶ Presburger automata membership problem is PTIME.
- Challenging problems:
 - ▶ Complexity of the VAS reachability problem.
 - ▶ Efficient algorithm for it.