

Invariant measures of discrete interacting particles systems: algebraic aspects

Luis Fredes

(joint work with J.F. Marckert).

École d'été St. Flour 2018



université
de BORDEAUX

Particle system

Define a set of κ colors $E_\kappa := \{0, 1, \dots, \kappa - 1\}$ for $\kappa \in \{\infty, 2, 3, \dots\}$.

An **interacting particle system (IPS)** is a stochastic process $(\eta_t)_{t \in \mathbb{R}^+}$ embedded on a graph $G = (V, E)$ with configuration space in S^V . We will work with $S = E_\kappa$ and with $G = \mathbb{Z}, \mathbb{Z}/n\mathbb{Z}$. .

Particle system

Define a set of κ colors $E_\kappa := \{0, 1, \dots, \kappa - 1\}$ for $\kappa \in \{\infty, 2, 3, \dots\}$.

An **interacting particle system (IPS)** is a stochastic process $(\eta_t)_{t \in \mathbb{R}^+}$ embedded on a graph $G = (V, E)$ with configuration space in S^V . We will work with $S = E_\kappa$ and with $G = \mathbb{Z}, \mathbb{Z}/n\mathbb{Z}$. .



TASEP

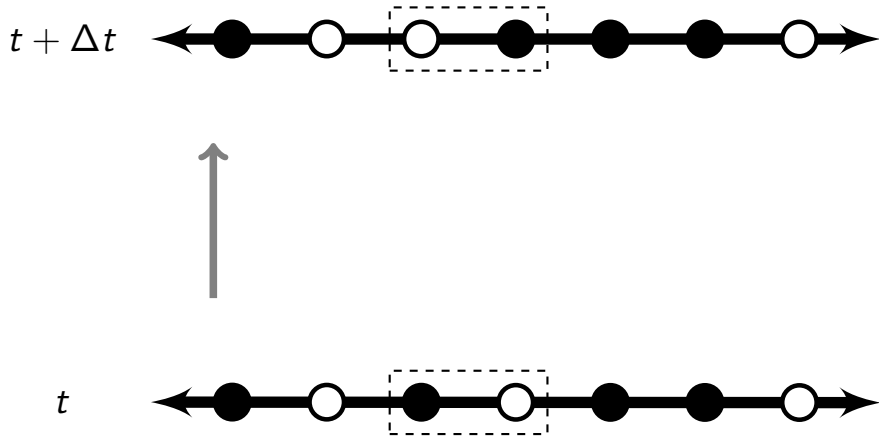

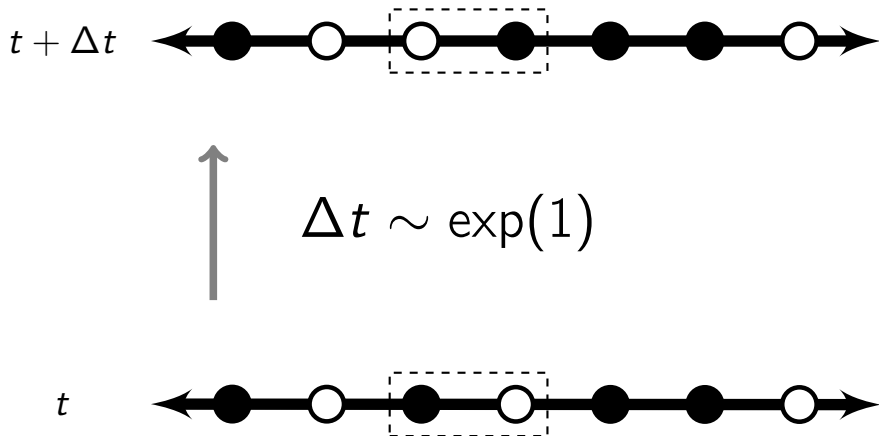

Contact process

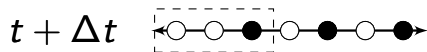

$$\Delta t \sim \exp(1)$$

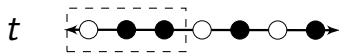

Contact process

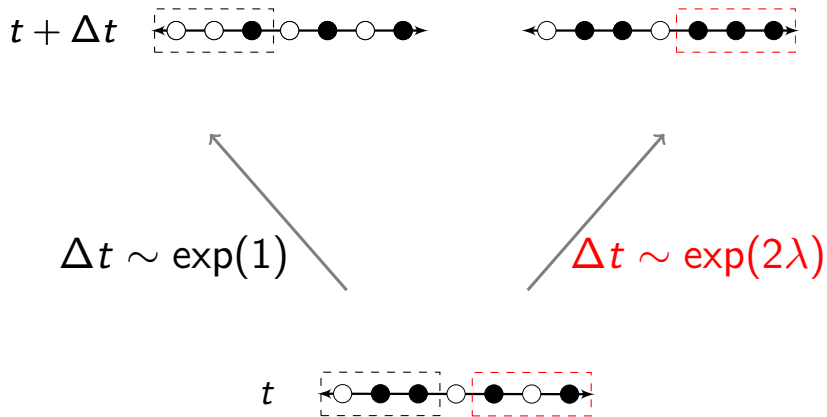

General case

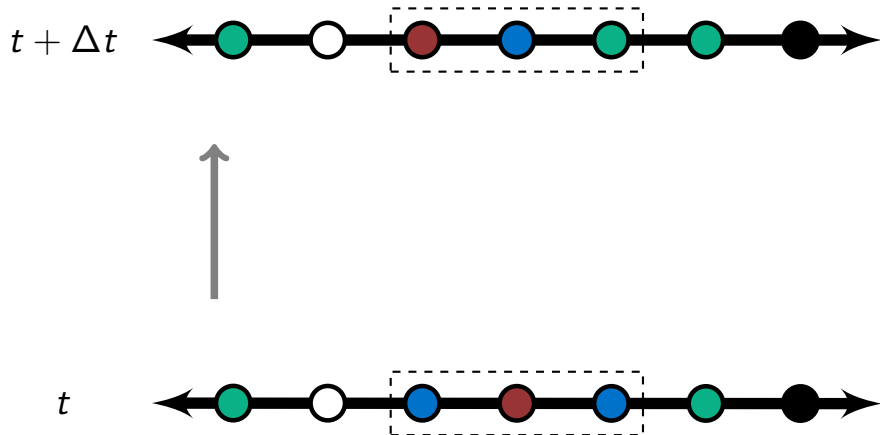

General case

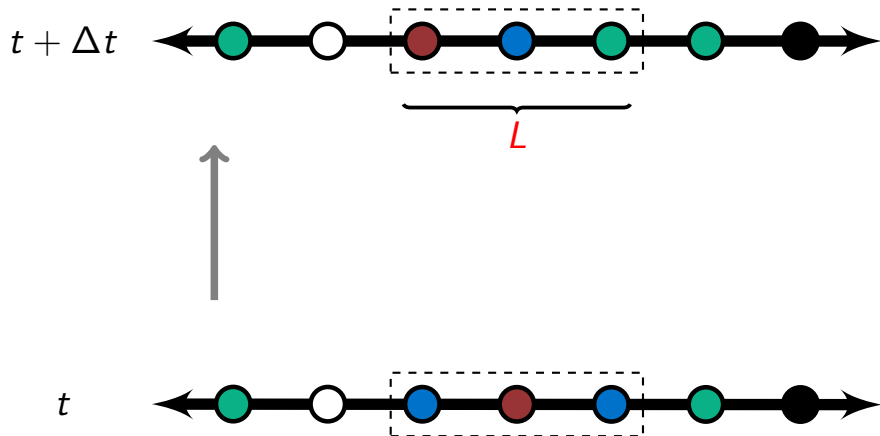

General case

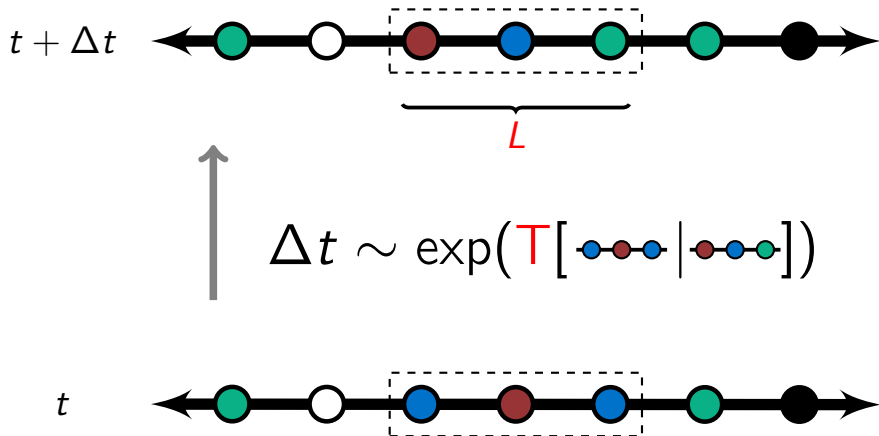

Invariant measure of particle system

Definition

A distribution μ on E_κ^V is said to be *invariant* if $\eta^t \sim \mu$ for any $t \geq 0$, when $\eta^0 \sim \mu$.

Invariant measure of particle system

Definition

A distribution μ on E_κ^V is said to be *invariant* if $\eta^t \sim \mu$ for any $t \geq 0$, when $\eta^0 \sim \mu$.

Usual questions in the topic:

Invariant measure of particle system

Definition

A distribution μ on E_κ^V is said to be *invariant* if $\eta^t \sim \mu$ for any $t \geq 0$, when $\eta^0 \sim \mu$.

Usual questions in the topic:

- Existence?

Invariant measure of particle system

Definition

A distribution μ on E_κ^V is said to be *invariant* if $\eta^t \sim \mu$ for any $t \geq 0$, when $\eta^0 \sim \mu$.

Usual questions in the topic:

- Existence?
- Uniqueness?

Invariant measure of particle system

Definition

A distribution μ on E_κ^V is said to be *invariant* if $\eta^t \sim \mu$ for any $t \geq 0$, when $\eta^0 \sim \mu$.

Usual questions in the topic:

- Existence?
- Uniqueness?
- Convergence?

Invariant measure of particle system

Definition

A distribution μ on E_κ^V is said to be *invariant* if $\eta^t \sim \mu$ for any $t \geq 0$, when $\eta^0 \sim \mu$.

Usual questions in the topic:

- Existence?
- Uniqueness?
- Convergence?
- Rate of convergence?

Invariant measure of particle system

Definition

A distribution μ on E_κ^V is said to be *invariant* if $\eta^t \sim \mu$ for any $t \geq 0$, when $\eta^0 \sim \mu$.

Usual questions in the topic:

- Existence?
- Uniqueness?
- Convergence?
- Rate of convergence?
- Simple representation?

Invariant measure of particle system

Definition

A distribution μ on E_κ^V is said to be *invariant* if $\eta^t \sim \mu$ for any $t \geq 0$, when $\eta^0 \sim \mu$.

Usual questions in the topic:

- Existence?
- Uniqueness?
- Convergence?
- Rate of convergence?
- Simple representation? (Integrability)

Some things (not much) are known about I.I.D.
random invariant distributions of IPS.

Some things (not much) are known about I.I.D. random invariant distributions of IPS. [[Andjel '82](#), [Ferrari '93](#), [Balazs–Rassoul-Agha–Seppalainen–Sethuraman '07](#), [Borodin–Corwin '11](#), [Fajfrová–Gobron–Saada '16...](#)]

Some things (not much) are known about I.I.D. random invariant distributions of IPS. [Andjel '82, Ferrari '93, Balazs–Rassoul-Agha–Seppalainen–Sethuraman '07, Borodin–Corwin '11, Fajfrová–Gobron–Saada '16...]



What about another type of distribution?

Some things (not much) are known about I.I.D. random invariant distributions of IPS. [Andjel '82, Ferrari '93, Balazs–Rassoul-Agha–Seppalainen–Sethuraman '07, Borodin–Corwin '11, Fajfrová–Gobron–Saada '16...]



What about another type of distribution?

MARKOV!!!!!!

Consider a Markov distribution (MD) (ρ, M) , with Markov Kernel (MK) M of memory $m = 1$ and ρ the invariant measure of M , i.e. for any $x \in E_{\mathcal{K}}^{\llbracket a, b \rrbracket}$

$$\mathbb{P}(X \llbracket a, b \rrbracket = x) = \rho_{x_a} \prod_{j=a}^{b-1} M_{x_j, x_{j+1}} \quad .$$

Consider a Markov distribution (MD) (ρ, M) , with Markov Kernel (MK) M of memory $m = 1$ and ρ the invariant measure of M , i.e. for any $x \in E_{\kappa}^{\llbracket a, b \rrbracket}$

$$\mathbb{P}(X \llbracket a, b \rrbracket = x) = \rho_{x_a} \prod_{j=a}^{b-1} M_{x_j, x_{j+1}} =: \gamma(x).$$

Denote by μ^t the measure of the process on $E_{\kappa}^{\mathbb{Z}}$ at time $t \geq 0$.

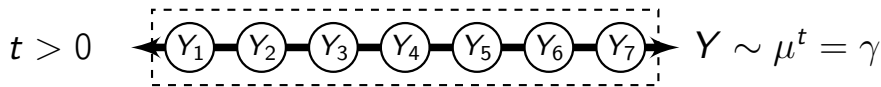

Evolution under T

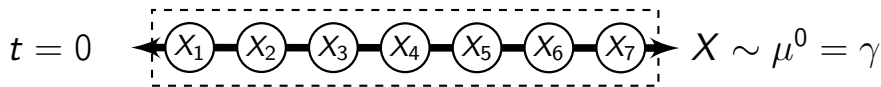

Definition

A process $(X_k, k \in \mathbb{Z}/n\mathbb{Z})$ taking its values in $E_{\kappa}^{\mathbb{Z}/n\mathbb{Z}}$ is said to have a Gibbs distribution $G(M)$ characterized by a MK M , if for any $x \in E_{\kappa}^{\llbracket 0, n-1 \rrbracket}$,

$$\mathbb{P}(X \llbracket 0, n-1 \rrbracket = x) = \frac{\prod_{j=0}^{n-1} M_{x_j, x_{j+1 \bmod n}}}{\text{Trace}(M^n)} .$$

Definition

A process $(X_k, k \in \mathbb{Z}/n\mathbb{Z})$ taking its values in $E_\kappa^{\mathbb{Z}/n\mathbb{Z}}$ is said to have a Gibbs distribution $G(M)$ characterized by a MK M , if for any $x \in E_\kappa^{\llbracket 0, n-1 \rrbracket}$,

$$\mathbb{P}(X \llbracket 0, n-1 \rrbracket = x) = \frac{\prod_{j=0}^{n-1} M_{x_j, x_{j+1 \bmod n}}}{\text{Trace}(M^n)} =: \nu(x).$$

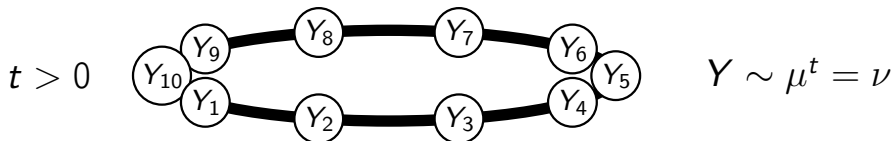

↑ Evolution under T

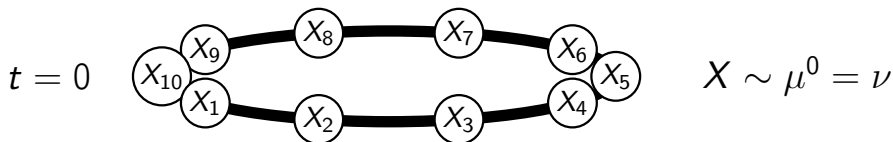

Theorem 1 (F- Marckert '17)

Let E_κ be finite, $L = 2$, $m = 1$. If $M > 0$ then the following statements are equivalent for the couple (T, M) :

- 1 (ρ, M) is invariant by T on \mathbb{Z} .
- 2 $G(M)$ is invariant by T on $\mathbb{Z}/n\mathbb{Z}$, for all $n \geq 3$
- 3 $G(M)$ is invariant by T on $\mathbb{Z}/7\mathbb{Z}$
- 4 A finite system of equations of degree 7 in M and linear in T .

Suppose μ^t is described with a MD. For any $x \in E_{\kappa}^{\llbracket 1, n \rrbracket}$ we define

$$\text{Line}_n^{M, \mathbb{T}}(x) := \frac{\partial}{\partial t} \mu_{\llbracket 1, n \rrbracket}^t(x)$$

Suppose μ^t is described with a MD. For any $x \in E_{\kappa}^{\llbracket 1, n \rrbracket}$ we define

$$\text{Line}_n^{M, T}(x) := \frac{\partial}{\partial t} \mu_{\llbracket 1, n \rrbracket}^t(x)$$

Definition

A (ρ, M) MD under its invariant distribution is said to be AI by T on the line when $\text{Line}_n \equiv 0$, for all $n \in \mathbb{N}$.



But you are CHEATING!!!

Suppose μ^t is described with a MD. For any $x \in E_{\kappa}^{\llbracket 1, n \rrbracket}$ we define

$$\text{Line}_n^{M, T}(x) := \frac{\partial}{\partial t} \mu_{\llbracket 1, n \rrbracket}^t(x)$$

Definition

A (ρ, M) MD under its invariant distribution is said to be AI by T on the line when $\text{Line}_n \equiv 0$, for all $n \in \mathbb{N}$.

Suppose μ^t is described with a MD. For any $x \in E_{\kappa}^{\llbracket 1, n \rrbracket}$ we define

$$\text{Line}_n^{M, T}(x) := \frac{\partial}{\partial t} \mu_{\llbracket 1, n \rrbracket}^t(x)$$

= Mass creation rate of x

– Mass destruction rate of x

Definition

A (ρ, M) MD under its invariant distribution is said to be AI by T on the line when $\text{Line}_n \equiv 0$, for all $n \in \mathbb{N}$.

Suppose μ^t is described with a MD. For any $x \in E_{\kappa}^{\llbracket 1, n \rrbracket}$ we define

$$\text{Line}_n^{M, T}(x) := \frac{\partial}{\partial t} \mu_{\llbracket 1, n \rrbracket}^t(x)$$

$$= \lim_{h \rightarrow 0} \sum_{w \in E_{\kappa}^{\mathbb{Z}}} \mathbb{P}(\eta^{t+h} \llbracket 1, n \rrbracket = x | \eta^t = w)$$

– Mass destruction rate of x

Definition

A (ρ, M) MD under its invariant distribution is said to be AI by T on the line when $\text{Line}_n \equiv 0$, for all $n \in \mathbb{N}$.

Suppose μ^t is described with a MD. For any $x \in E_{\kappa}^{\llbracket 1, n \rrbracket}$ we define

$$\text{Line}_n^{M, T}(x) := \frac{\partial}{\partial t} \mu_{\llbracket 1, n \rrbracket}^t(x)$$

$$= \lim_{h \rightarrow 0} \sum_{w \in E_{\kappa}^{\mathbb{Z}}} \mathbb{P}(\eta^{t+h} \llbracket 1, n \rrbracket = x | \eta^t = w) \\ - \lim_{h \rightarrow 0} \sum_{w \in E_{\kappa}^{\mathbb{Z}}} \mathbb{P}(\eta^{t+h} = w | \eta^t \llbracket 1, n \rrbracket = x)$$

Definition

A (ρ, M) MD under its invariant distribution is said to be AI by T on the line when $\text{Line}_n \equiv 0$, for all $n \in \mathbb{N}$.

Suppose μ^t is described with a MD. For any $x \in E_\kappa^{[1,n]}$ we define

$$\text{Line}_n^{M,T}(x) := \frac{\partial}{\partial t} \mu_{[1,n]}^t(x)$$

$$= \lim_{h \rightarrow 0} \sum_{w \in E_\kappa^{\mathbb{Z}}} \mathbb{P}(\eta^{t+h}[[1, n]] = x | \eta^t = w) \\ - \sum_{\substack{x_{-1}, x_0, \\ x_{n+1}, x_{n+2} \in E_\kappa}} \sum_{j=0}^n \gamma(x[[-1, n+2]]) \sum_{(u,v) \in E_\kappa^2} T_{[x_j, x_{j+1} | u, v]}$$

where w^k differs from x in $w^k[[k, k+1]] = (u, v)$.

Definition

A (ρ, M) MD under its invariant distribution is said to be AI by T on the line when $\text{Line}_n \equiv 0$, for all $n \in \mathbb{N}$.

Suppose μ^t is described with a MD. For any $x \in E_{\kappa}^{\llbracket 1, n \rrbracket}$ we define

$$\begin{aligned} \text{Line}_n^{M, T}(x) &:= \frac{\partial}{\partial t} \mu_{\llbracket 1, n \rrbracket}^t(x) \\ &= \sum_{\substack{x_{-1}, x_0, \\ x_{n+1}, x_{n+2} \in E_{\kappa}}} \sum_{j=0}^n \sum_{(u, v) \in E_{\kappa}^2} \gamma(w^j \llbracket -1, n+2 \rrbracket) T_{[u, v | x_j, x_{j+1}]} \\ &\quad - \sum_{\substack{x_{-1}, x_0, \\ x_{n+1}, x_{n+2} \in E_{\kappa}}} \sum_{j=0}^n \gamma(x \llbracket -1, n+2 \rrbracket) \sum_{(u, v) \in E_{\kappa}^2} T_{[x_j, x_{j+1} | u, v]} \end{aligned}$$

where w^k differs from x in $w^k \llbracket k, k+1 \rrbracket = (u, v)$.

Definition

A (ρ, M) MD under its invariant distribution is said to be AI by T on the line when $\text{Line}_n \equiv 0$, for all $n \in \mathbb{N}$.

Suppose μ^t is described with a MD. For any $x \in E_{\kappa}^{\llbracket 1, n \rrbracket}$ we define

$$\begin{aligned} \text{Line}_n^{M, T}(x) &:= \frac{\partial}{\partial t} \mu_{\llbracket 1, n \rrbracket}^t(x) \\ &= \sum_{\substack{x_{-1}, x_0, \\ x_{n+1}, x_{n+2} \in E_{\kappa}}} \sum_{j=0}^n \left(\sum_{(u, v) \in E_{\kappa}^2} \gamma(w^j \llbracket -1, n+2 \rrbracket) T_{[u, v | x_j, x_{j+1}]} \right. \\ &\quad \left. - \gamma(x \llbracket -1, n+2 \rrbracket) \sum_{(u, v) \in E_{\kappa}^2} T_{[x_j, x_{j+1} | u, v]} \right) \end{aligned}$$

where w^k differs from x in $w^k \llbracket k, k+1 \rrbracket = (u, v)$.

Definition

A (ρ, M) MD under its invariant distribution is said to be AI by T on the line when $\text{Line}_n \equiv 0$, for all $n \in \mathbb{N}$.

Suppose μ^t is described with a MD. For any $x \in E_{\kappa}^{[1,n]}$ we define

$$\begin{aligned} \text{Line}_n^{M,T}(x) &:= \frac{\partial}{\partial t} \mu_{[1,n]}^t(x) \\ &= \sum_{\substack{x_{-1}, x_0, \\ x_{n+1}, x_{n+2} \in E_{\kappa}}} \sum_{j=0}^n \left(\sum_{(u,v) \in E_{\kappa}^2} \left(\rho_{x_{-1}} \prod_{\substack{-1 \leq k \leq n+1 \\ k \notin \{j-1, j, j+1\}}} M_{x_k, x_{k+1}} \right) M_{x_{j-1}, u} M_{u, v} M_{v, x_{j+2}} T_{[u, v | x_j, x_{j+1}]} \right. \\ &\quad \left. - \left(\rho_{x_{-1}} \prod_{k=-1}^{n+1} M_{x_k, x_{k+1}} \right) T_{[x_j, x_{j+1}]}^{\text{out}} \right) \end{aligned}$$

Definition

A (ρ, M) MD is said to be invariant by T on the line when $\text{Line}_n \equiv 0$, for all $n \in \mathbb{N}$.

Suppose μ^t is described with a MD. For any $x \in E_{\kappa}^{[1,n]}$ we define

$$\begin{aligned} \text{Line}_n^{M,T}(x) &:= \frac{\partial}{\partial t} \mu_{[1,n]}^t(x) \\ &= \sum_{\substack{x_{-1}, x_0, \\ x_{n+1}, x_{n+2} \in E_{\kappa}}} \sum_{j=0}^n \left(\rho_{x_{-1}} \prod_{k=-1}^{n+1} M_{x_k, x_{k+1}} \right) \times \\ &\quad \left(\left(\sum_{(u,v) \in E_{\kappa}^2} T_{[u,v|x_j, x_{j+1}]} \frac{M_{x_{j-1}, u} M_{u,v} M_{v, x_{j+2}}}{M_{x_{j-1}, x_j} M_{x_j, x_{j+1}} M_{x_{j+1}, x_{j+2}}} \right) - T_{[x_j, x_{j+1}]}^{\text{out}} \right) \end{aligned}$$

Definition

A (ρ, M) MD is said to be invariant by T on the line when $\text{Line}_n \equiv 0$, for all $n \in \mathbb{N}$.

Suppose μ^t is described with a MD. For any $x \in E_{\kappa}^{[1,n]}$ we define

$$\begin{aligned} \text{Line}_n^{M,T}(x) &:= \frac{\partial}{\partial t} \mu_{[1,n]}^t(x) \\ &= \sum_{\substack{x_{-1}, x_0, \\ x_{n+1}, x_{n+2} \in E_{\kappa}}} \sum_{j=0}^n \left(\rho_{x_{-1}} \prod_{k=-1}^{n+1} M_{x_k, x_{k+1}} \right) \times \\ &\quad \underbrace{\left(\left(\sum_{(u,v) \in E_{\kappa}^2} T_{[u,v|x_j, x_{j+1}]} \frac{M_{x_{j-1}, u} M_{u,v} M_{v, x_{j+2}}}{M_{x_{j-1}, x_j} M_{x_j, x_{j+1}} M_{x_{j+1}, x_{j+2}}} \right) - T_{[x_j, x_{j+1}]}^{\text{out}} \right)}_{Z_{x_{j-1}, x_j, x_{j+1}, x_{j+2}}} \end{aligned}$$

Definition

A (ρ, M) MD is said to be invariant by T on the line when $\text{Line}_n \equiv 0$, for all $n \in \mathbb{N}$.

Definitions

- Define for every $a, b, c, d \in E_\kappa$

$$Z_{a,b,c,d}^{M,T} := \left(\sum_{(u,v) \in E_\kappa^2} T_{[u,v|b,c]} \frac{M_{a,u} M_{u,v} M_{v,d}}{M_{a,b} M_{b,c} M_{c,d}} \right) - T_{[b,c]}^{\text{out}}.$$

Definition

A Gibbs measure with kernel M is said to be invariant by T on $\mathbb{Z}/n\mathbb{Z}$ when $\text{Cycle}_n \equiv 0$, where

$$\begin{aligned} \text{Cycle}_n(x) \\ &:= \sum_{j=0}^{n-1} \sum_{u,v \in E_\kappa} \left(\nu(w^j) T_{[u,v | x_j, x_{j+1 \bmod n}]} - \nu(x) T_{[x_j, x_{j+1 \bmod n}]}^{\text{out}} \right) \end{aligned}$$

where w^k differs from x in $w^k \llbracket k, k+1 \bmod n \rrbracket = (u, v)$.

Definition

A Gibbs measure with kernel M is said to be invariant by T on $\mathbb{Z}/n\mathbb{Z}$ when $\text{Cycle}_n \equiv 0$, where

$\text{Cycle}_n(x)$

$$:= \nu(x) \times \sum_{j=0}^{n-1} Z_{x_{j-1}, x_j, x_{j+1}, x_{j+2}}$$

where w^k differs from x in $w^k \llbracket k, k+1 \text{ mod } n \rrbracket = (u, v)$.

Extensions

Theorem 1 (F- Marckert)

Let E_κ be finite, $L = 2$, $m = 1$. If $M > 0$ then the following statements are equivalent:

- 1 (ρ, M) is invariant by T on \mathbb{Z} .
- 2 $G(M)$ is invariant by T on $\mathbb{Z}/n\mathbb{Z}$, for all $n \geq 3$
- 3 $G(M)$ is invariant by T on $\mathbb{Z}/7\mathbb{Z}$
- 4 A finite system of equations of degree 7 in M and linear in T .

Memory and amplitude

Theorem 1- Strongest form (F- Marckert '17)

Let E_κ be finite, $L \geq 2$, $m \in \mathbb{N}$. If $M > 0$ then the following statements are equivalent:

- 1 (ρ, M) is invariant by T on \mathbb{Z} .
- 2 $G(M)$ is invariant by T on $\mathbb{Z}/n\mathbb{Z}$, for all $n \geq m + L$
- 3 $G(M)$ is invariant by T on $\mathbb{Z}/h\mathbb{Z}$
- 4 A finite system of equations of degree h in M and linear in T .

$$h := 4m + 2L - 1$$

Other extensions:

- Theorem 1 when $\kappa = \infty$.

Other extensions:

- Theorem 1 when $\kappa = \infty$.
- I.I.D. invariant measures on \mathbb{Z}^d .

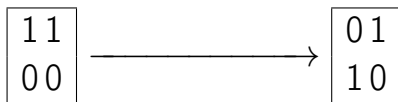

Other extensions:

- Theorem 1 when $\kappa = \infty$.
- I.I.D. invariant measures on \mathbb{Z}^d .

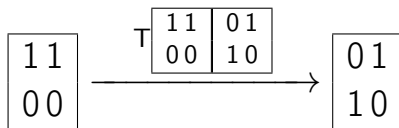

Other extensions:

- Theorem 1 when $\kappa = \infty$.
- I.I.D. invariant measures on \mathbb{Z}^d .

$$\begin{array}{|c|} \hline 11 \\ \hline 00 \\ \hline \end{array} \xrightarrow{\begin{array}{|c|c|} \hline 11 & 01 \\ \hline 00 & 10 \\ \hline \end{array}} \begin{array}{|c|} \hline 01 \\ \hline 10 \\ \hline \end{array}$$

- We link our results with the TASEP's matrix ansatz.

Other extensions:

- Theorem 1 when $\kappa = \infty$.
- I.I.D. invariant measures on \mathbb{Z}^d .

$$\begin{array}{|c|} \hline 11 \\ \hline 00 \\ \hline \end{array} \xrightarrow{\begin{array}{|c|c|} \hline 11 & 01 \\ \hline 00 & 10 \\ \hline \end{array}} \begin{array}{|c|} \hline 01 \\ \hline 10 \\ \hline \end{array}$$

- We link our results with the TASEP's matrix ansatz.
- **Problem:** MK with zero entries.

Applications

Theorem 3 (F.- Marckert '17)

Consider $\kappa < \infty$. Consider an IRM T with amplitude L , which is not identically 0.

If for infinitely many integers n the IPS with IRM T possesses an absorbing subset S_n of $E_\kappa^{\mathbb{Z}/n\mathbb{Z}}$, with $\emptyset \subsetneq S_n \subsetneq E_\kappa^{\mathbb{Z}/n\mathbb{Z}}$. Then, there does not exist any MD with any memory m with full support, invariant by T on the line.

Theorem 3 (F.- Marckert '17)

Consider $\kappa < \infty$. Consider an IRM T with amplitude L , which is not identically 0.

If for infinitely many integers n the IPS with IRM T possesses an absorbing subset S_n of $E_\kappa^{\mathbb{Z}/n\mathbb{Z}}$, with $\emptyset \subsetneq S_n \subsetneq E_\kappa^{\mathbb{Z}/n\mathbb{Z}}$. Then, there does not exist any MD with any memory m with full support, invariant by T on the line.

Corollary

The contact process do not have a MD of any memory $m \geq 0$ as invariant distribution.

Summary of other applications

- The case $\kappa = 2$, $m = 1$ and $L = 2$ is totally explicitly solved.

Summary of other applications

- The case $\kappa = 2$, $m = 1$ and $L = 2$ is totally explicitly solved.
- For $\kappa < \infty$, $L = 2$ and $m = 1$ we have an algorithm to find the set of all possible M MK which are invariant for a given T .

Summary of other applications

- The case $\kappa = 2$, $m = 1$ and $L = 2$ is totally explicitly solved.
- For $\kappa < \infty$, $L = 2$ and $m = 1$ we have an algorithm to find the set of all possible M MK which are invariant for a given T .
- Examples of I.I.D. invariant measures on \mathbb{Z}^2 .

Summary of other applications

- The case $\kappa = 2$, $m = 1$ and $L = 2$ is totally explicitly solved.
- For $\kappa < \infty$, $L = 2$ and $m = 1$ we have an algorithm to find the set of all possible M MK which are invariant for a given T .
- Examples of I.I.D. invariant measures on \mathbb{Z}^2 .
- Zero range, voter model, etc. Also when we make mild changes on these models we have some results.

Summary of other applications

- The case $\kappa = 2$, $m = 1$ and $L = 2$ is totally explicitly solved.
- For $\kappa < \infty$, $L = 2$ and $m = 1$ we have an algorithm to find the set of all possible M MK which are invariant for a given T .
- Examples of I.I.D. invariant measures on \mathbb{Z}^2 .
- Zero range, voter model, etc. Also when we make mild changes on these models we have some results.
- We find an IRM T which possesses some hidden Markov chain as invariant distributions. It is done using a projection from E_3 to E_2 .

Thank you!