

Strategies for Replica Placement in Tree Networks

Anne Benoit, Veronika Rehn and Yves Robert

GRAAL team, LIP
École Normale Supérieure de Lyon

October 2006

Introduction and motivation

- Replica placement in tree networks
- Set of clients (tree leaves): requests with QoS constraints, known in advance
- Internal nodes may be provided with a replica; then nodes become servers, able to process requests (up to their capacity limit)

How many replicas required?

Which locations?

Total replica cost?

Introduction and motivation

- Replica placement in tree networks
- Set of clients (tree leaves): requests with QoS constraints, known in advance
- Internal nodes may be provided with a replica; then nodes become servers, able to process requests (up to their capacity limit)

How many replicas required?

Which locations?

Total replica cost?

Introduction and motivation

- Replica placement in tree networks
- Set of clients (tree leaves): requests with QoS constraints, known in advance
- Internal nodes may be provided with a replica; then nodes become servers, able to process requests (up to their capacity limit)

How many replicas required?

Which locations?

Total replica cost?

Introduction and motivation

- Replica placement in tree networks
- Set of clients (tree leaves): requests with QoS constraints, known in advance
- Internal nodes may be provided with a replica; then nodes become servers, able to process requests (up to their capacity limit)

How many replicas required?

Which locations?

Total replica cost?

Rule of the game

- Handle all client requests, and minimize cost of replicas
- → REPLICAS PLACEMENT problem
- Several policies to assign replicas

Rule of the game

- Handle all client requests, and minimize cost of replicas
- → REPLICA PLACEMENT problem
- Several policies to assign replicas

Rule of the game

- Handle all client requests, and minimize cost of replicas
- → REPLICAS PLACEMENT problem
- Several policies to assign replicas

Major contributions

Theory New access policies
 Problem complexity
 LP-based lower bound to cost of REPLICAS
 PLACEMENT

Practice Heuristics for each policy
 Experiments to assess impact of new policies

Major contributions

Theory New access policies
Problem complexity
LP-based lower bound to cost of REPLICAPLACEMENT

Practice Heuristics for each policy
Experiments to assess impact of new policies

Outline

- 1 Framework
- 2 Access policies
- 3 Complexity results
- 4 Linear programming formulation
- 5 Heuristics for the REPLICAS COST problem
- 6 Experiments
- 7 Extensions
- 8 Conclusion

Outline

- 1 Framework
- 2 Access policies
- 3 Complexity results
- 4 Linear programming formulation
- 5 Heuristics for the REPLICATOR COST problem
- 6 Experiments
- 7 Extensions
- 8 Conclusion

Definitions and notations

- Distribution tree \mathcal{T} , clients \mathcal{C} (leaf nodes), internal nodes \mathcal{N}
- **Client** $i \in \mathcal{C}$:
 - Sends r_i requests per time unit (number of accesses to a single object database)
 - Quality of service q_i (response time)
- **Node** $j \in \mathcal{N}$:
 - Can contain the object database replica (server) or not
 - Processing capacity W_j
 - Storage cost sc_j
- **Tree edge:** $l \in \mathcal{L}$ (communication link between nodes)
 - Communication time $comm_l$
 - Bandwidth limit BW_l

Definitions and notations

- Distribution tree \mathcal{T} , clients \mathcal{C} (leaf nodes), internal nodes \mathcal{N}
- **Client** $i \in \mathcal{C}$:
 - Sends r_i requests per time unit (number of accesses to a single object database)
 - Quality of service q_i (response time)
- **Node** $j \in \mathcal{N}$:
 - Can contain the object database replica (server) or not
 - Processing capacity W_j
 - Storage cost sc_j
- **Tree edge:** $l \in \mathcal{L}$ (communication link between nodes)
 - Communication time $comm_l$
 - Bandwidth limit BW_l

Definitions and notations

- Distribution tree \mathcal{T} , clients \mathcal{C} (leaf nodes), internal nodes \mathcal{N}
- **Client** $i \in \mathcal{C}$:
 - Sends r_i requests per time unit (number of accesses to a single object database)
 - Quality of service q_i (response time)
- **Node** $j \in \mathcal{N}$:
 - Can contain the object database replica (server) or not
 - Processing capacity W_j
 - Storage cost sc_j
- **Tree edge:** $l \in \mathcal{L}$ (communication link between nodes)
 - Communication time $comm_l$
 - Bandwidth limit BW_l

Definitions and notations

- Distribution tree \mathcal{T} , clients \mathcal{C} (leaf nodes), internal nodes \mathcal{N}
- **Client** $i \in \mathcal{C}$:
 - Sends r_i requests per time unit (number of accesses to a single object database)
 - Quality of service q_i (response time)
- **Node** $j \in \mathcal{N}$:
 - Can contain the object database replica (server) or not
 - Processing capacity W_j
 - Storage cost sc_j
- **Tree edge:** $l \in \mathcal{L}$ (communication link between nodes)
 - Communication time $comm_l$
 - Bandwidth limit BW_l

Tree notations

- r : tree **root**
- **children**(j): set of children of node $j \in \mathcal{N}$
- **parent**(k): parent in the tree of node $k \in \mathcal{N} \cup \mathcal{C}$
- link $l : k \rightarrow \text{parent}(k) = k'$. Then **succ**(l) is the link $k' \rightarrow \text{parent}(k')$ (when it exists)
- **Ancestors**(k): set of ancestors of node k
- If $k' \in \text{Ancestors}(k)$, then **path**[$k \rightarrow k'$]: set of links in the path from k to k'
- **subtree**(k): subtree rooted in k , including k .

Problem instances

- Goal: place replicas to process client requests
- Client $i \in \mathcal{C}$: $\text{Servers}(i) \subseteq \mathcal{N}$ is the set of servers responsible for processing its requests
- $r_{i,s}$: number of requests from client i processed by server s
 $(\sum_{s \in \text{Servers}(i)} r_{i,s} = r_i)$
- $R = \{s \in \mathcal{N} \mid \exists i \in \mathcal{C}, s \in \text{Servers}(i)\}$: set of replicas

Constraints

- **Server capacity** – $\forall s \in R, \sum_{i \in \mathcal{C} | s \in \text{Servers}(i)} r_{i,s} \leq W_s$
- **QoS** – $\forall i \in \mathcal{C}, \forall s \in \text{Servers}(i), \sum_{l \in \text{path}[i \rightarrow s]} \text{comm}_l \leq q_i$.
- **Link capacity** – $\forall l \in \mathcal{L} \sum_{i \in \mathcal{C}, s \in \text{Servers}(i) | l \in \text{path}[i \rightarrow s]} r_{i,s} \leq \text{BW}_l$

Objective function

- $\text{Min } \sum_{s \in R} sc_s$
- Restrict to case where $sc_s = W_s$
- REPLICAS COST problem: no QoS nor bandwidth constraints; heterogeneous servers
- REPLICAS COUNTING problem: idem, but homogeneous platforms

Objective function

- $\text{Min } \sum_{s \in R} sc_s$
- Restrict to case where $sc_s = W_s$
- REPLICAS COST problem: no QoS nor bandwidth constraints; heterogeneous servers
- REPLICAS COUNTING problem: idem, but homogeneous platforms

Outline

- 1 Framework
- 2 Access policies**
- 3 Complexity results
- 4 Linear programming formulation
- 5 Heuristics for the REPLICAS COST problem
- 6 Experiments
- 7 Extensions
- 8 Conclusion

Single server vs Multiple servers

Single server – Each **client** i is assigned a single server **server**(i), that is responsible for processing all its requests.

Multiple servers – A client i may be assigned several servers in a set **Servers**(i). Each server $s \in \text{Servers}(i)$ will handle a fraction $r_{i,s}$ of the requests.

In the literature: single server policy with additional constraint.

Closest policy

- *Closest*: single server policy
- Server of client i is constrained to be **first server** found on the path that goes from i upwards to the root of the tree
- Consider a client i and its server $\text{server}(i)$:
 $\forall i' \in \text{subtree}(\text{server}(i)), \text{server}(i') \in \text{subtree}(\text{server}(i))$
- Requests from i' cannot “traverse” $\text{server}(i)$ and be served higher

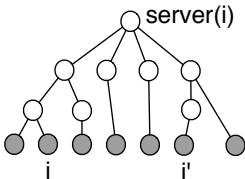

Upwards and Multiple policy

- New policies not studied in the literature
- *Upwards*: Closest constraint is relaxed
- *Multiple*: relax single server restriction
- Expect **more solutions** with new policies, at a lower cost
- **QoS constraints** may lower difference between policies

Example: existence of a solution

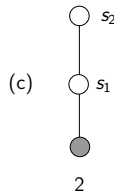
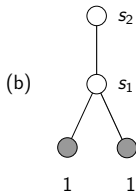
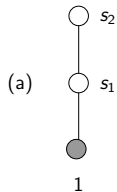
 $W = 1$

- (a): solution for all policies
- (b): no solution with *Closest*
- (c): no solution with *Closest* nor *Upwards*

Example: existence of a solution

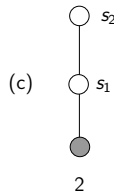
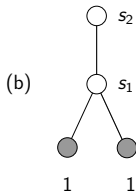
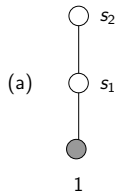
 $W = 1$

- (a): solution for all policies
- (b): no solution with *Closest*
- (c): no solution with *Closest* nor *Upwards*

Example: existence of a solution

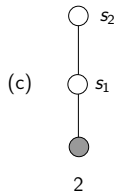
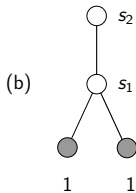
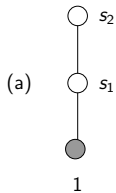
 $W = 1$

- (a): solution for all policies
- (b): no solution with *Closest*
- (c): no solution with *Closest* nor *Upwards*

Example: existence of a solution

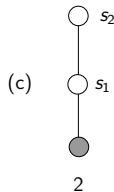
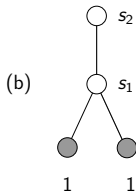
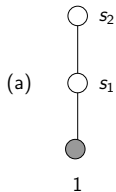
 $W = 1$

- (a): solution for all policies
- (b): no solution with *Closest*
- (c): no solution with *Closest* nor *Upwards*

Upwards versus Closest

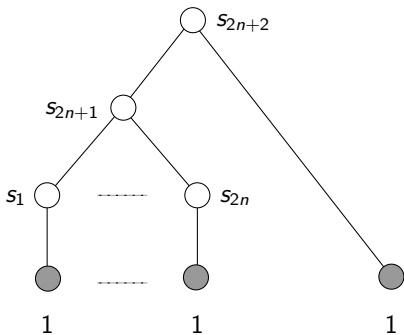

$$W = n$$

- *Upwards*: 3 replicas in s_{2n} , s_{2n+1} and s_{2n+2}
- *Closest*: at least $n + 2$ replicas (replica in s_{2n+1} or not)

Multiple versus Upwards

- REPLICAS COUNTING: *Multiple* twice better than *Upwards*.
- Performance ratio: open problem.

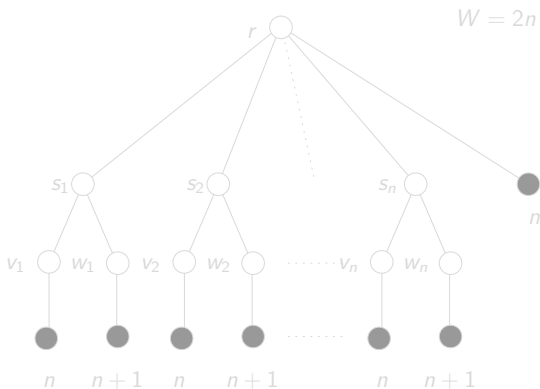

Multiple: $n + 1$ replicas / *Upwards*: $2n$ replicas

Multiple versus Upwards

- REPLICAS COUNTING: *Multiple* twice better than *Upwards*.
- Performance ratio: open problem.

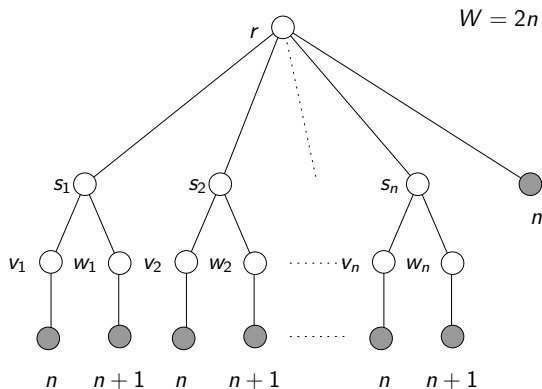

Multiple: $n + 1$ replicas / *Upwards*: $2n$ replicas

Multiple versus Upwards

- REPLICA COST: *Multiple* arbitrarily better than *Upwards*

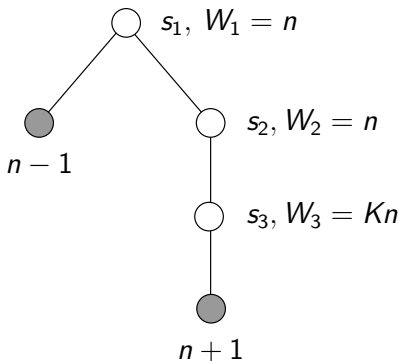

Multiple: cost $2n$ / *Upwards*: cost $(K+1)n$

Lower bound for the REPLICA COUNTING problem

Obvious lower bound: $\left\lceil \frac{\sum_{i \in C} r_i}{W} \right\rceil = 2$

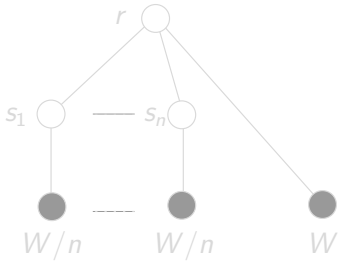

All policies require $n + 1$ replica (one at each node).

Lower bound for the REPLICA COUNTING problem

Obvious lower bound: $\left\lceil \frac{\sum_{i \in C} r_i}{W} \right\rceil = 2$

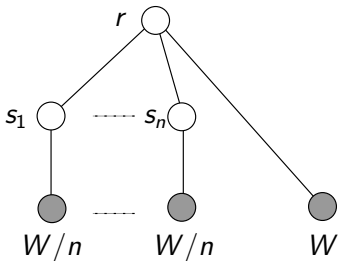

All policies require $n + 1$ replica (one at each node).

Outline

- 1 Framework
- 2 Access policies
- 3 Complexity results**
- 4 Linear programming formulation
- 5 Heuristics for the REPLICAS COST problem
- 6 Experiments
- 7 Extensions
- 8 Conclusion

Complexity results

	Homogeneous	Heterogeneous
Closest	polynomial [Cidon02,Liu06]	
Upwards		
Multiple		

Table: Complexity results for the different instances of the problem

- *Closest*/Homogeneous is the only known result (Cidon et al. 2002, Liu et al. 2006)

Complexity results

	Homogeneous	Heterogeneous
Closest	polynomial [Cidon02,Liu06]	
Upwards		
Multiple	polynomial algorithm	

Table: Complexity results for the different instances of the problem

- *Closest*/Homogeneous is the only known result (Cidon et al. 2002, Liu et al. 2006)
- *Multiple*/Homogeneous: nice algorithm to prove the polynomial complexity of the problem

Complexity results

	Homogeneous	Heterogeneous
Closest	polynomial [Cidon02,Liu06]	
Upwards	NP-complete	
Multiple	polynomial algorithm	

Table: Complexity results for the different instances of the problem

- *Closest*/Homogeneous is the only known result (Cidon et al. 2002, Liu et al. 2006)
- *Multiple*/Homogeneous: nice algorithm to prove the polynomial complexity of the problem
- *Upwards*/Homogeneous: surprisingly, NP-complete

Multiple/Homogeneous: greedy algorithm

3-pass algorithm:

- Select nodes which can handle W requests
- Select some extra servers to fulfill remaining requests
- Decide which requests are processed where

Example to illustrate algorithm (informally)

Proof of optimality: any optimal solution can be transformed into a solution similar to the one of the algorithm (moving requests from one server to another)

Multiple/Homogeneous: greedy algorithm

3-pass algorithm:

- Select nodes which can handle W requests
- Select some extra servers to fulfill remaining requests
- Decide which requests are processed where

Example to illustrate algorithm (informally)

Proof of optimality: any optimal solution can be transformed into a solution similar to the one of the algorithm (moving requests from one server to another)

Multiple/Homogeneous: greedy algorithm

3-pass algorithm:

- Select nodes which can handle W requests
- Select some extra servers to fulfill remaining requests
- Decide which requests are processed where

Example to illustrate algorithm (informally)

Proof of optimality: any optimal solution can be transformed into a solution similar to the one of the algorithm (moving requests from one server to another)

Multiple/Homogeneous: example

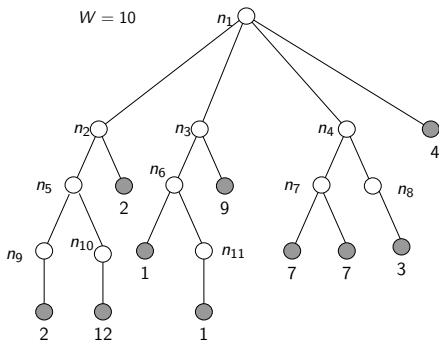

Initial network

The example network

Multiple/Homogeneous: example

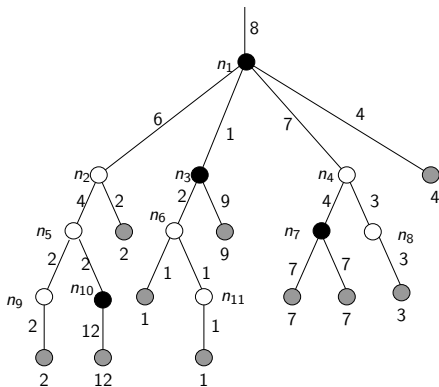

Pass 1

Placing *saturated* replicas

Multiple/Homogeneous: example

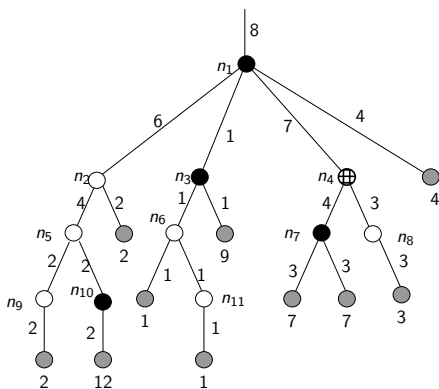

Pass 2

Placing extra replicas: n_4 has maximum useful flow

Multiple/Homogeneous: example

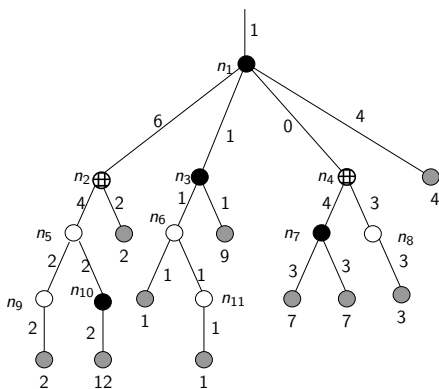

Pass 2

Placing extra replicas: n_2 is of maximum useful flow 1

Multiple/Homogeneous: example

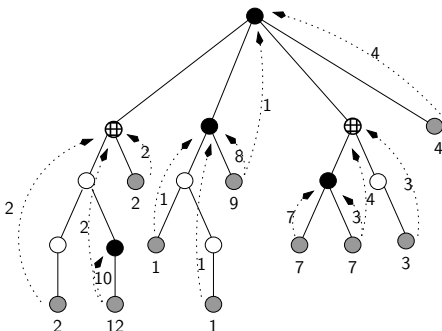

Pass 3

Deciding where requests are processed

Upwards/Homogeneous

- The REPLICA COUNTING problem with the *Upwards* strategy is NP-complete in the strong sense
- Reduction from 3-PARTITION

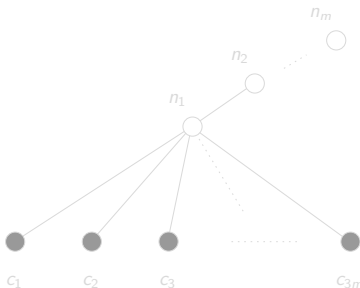

$$W = B$$

$$\sum_{i=1}^{3m} a_i = mB$$

Upwards/Homogeneous

- The **REPLICA COUNTING** problem with the *Upwards* strategy is NP-complete in the strong sense
- Reduction from 3-PARTITION

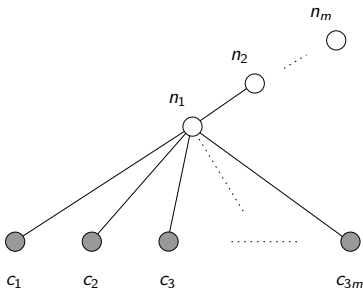

$$W = B$$

$$\sum_{i=1}^{3m} a_i = mB$$

Heterogeneous network: REPLICA COST problem

- All three instances of the REPLICA COST problem with heterogeneous nodes are NP-complete
- Reduction from 2-PARTITION

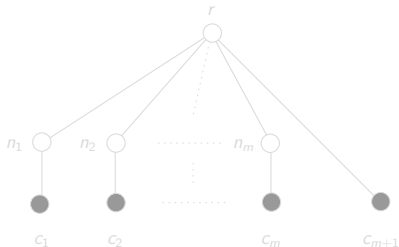

$$\sum_{i=1}^m a_i = S, a_{m+1} = 1, W_j = a_j, W_r = S/2 + 1$$

Solution with total storage cost $S + 1$?

Heterogeneous network: REPLICAS COST problem

- All three instances of the REPLICAS COST problem with heterogeneous nodes are NP-complete
- Reduction from 2-PARTITION

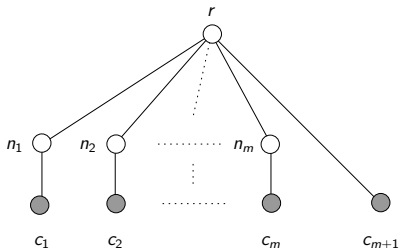

$$\sum_{i=1}^m a_i = S, a_{m+1} = 1, W_j = a_i, W_r = S/2 + 1$$

Solution with total storage cost $S + 1$?

Heterogeneous network: REPLICAS COST problem

- All three instances of the REPLICAS COST problem with heterogeneous nodes are NP-complete
- Reduction from 2-PARTITION

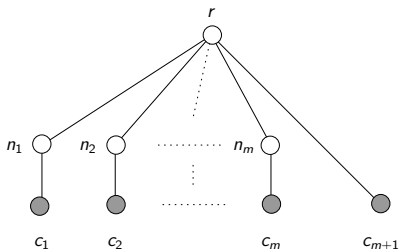

$$\sum_{i=1}^m a_i = S, a_{m+1} = 1, W_j = a_i, W_r = S/2 + 1$$

Solution with total storage cost $S + 1$?

Outline

- 1 Framework
- 2 Access policies
- 3 Complexity results
- 4 Linear programming formulation**
- 5 Heuristics for the REPLICAS COST problem
- 6 Experiments
- 7 Extensions
- 8 Conclusion

Linear programming

- **General instance** of the problem
 - Heterogeneous tree
 - QoS and bandwidth constraints
 - *Closest*, *Upwards* and *Multiple* policies
- **Integer linear program**: no efficient algorithm
- **Absolute lower bound** if program solved over the rationals (using the **GLPK** software)
- *Closest / Upwards LP formulation*

Linear programming

- **General instance** of the problem
 - Heterogeneous tree
 - QoS and bandwidth constraints
 - *Closest*, *Upwards* and *Multiple* policies
- **Integer linear program**: no efficient algorithm
- **Absolute lower bound** if program solved over the rationals (using the **GLPK** software)
- *Closest/Upwards LP formulation*

Linear program: variables

- x_j : boolean variable equal to 1 if j is a server (for one or several clients)
- $y_{i,j}$: boolean variable equal to 1 if $j = \text{server}(i)$
 - If $j \notin \text{Ancests}(i)$, $y_{i,j} = 0$
- $z_{i,l}$: boolean variable equal to 1 if link $l \in \text{path}[i \rightarrow r]$ used when i accesses server(i)
 - If $l \notin \text{path}[i \rightarrow r]$, $z_{i,l} = 0$

Objective function: $\sum_{j \in \mathcal{N}} sc_j x_j$

Linear program: variables

- x_j : boolean variable equal to 1 if j is a server (for one or several clients)
- $y_{i,j}$: boolean variable equal to 1 if $j = \text{server}(i)$
 - If $j \notin \text{Ancests}(i)$, $y_{i,j} = 0$
- $z_{i,l}$: boolean variable equal to 1 if link $l \in \text{path}[i \rightarrow r]$ used when i accesses server(i)
 - If $l \notin \text{path}[i \rightarrow r]$, $z_{i,l} = 0$

Objective function: $\sum_{j \in \mathcal{N}} sc_j x_j$

Linear program: variables

- x_j : boolean variable equal to 1 if j is a server (for one or several clients)
- $y_{i,j}$: boolean variable equal to 1 if $j = \text{server}(i)$
 - If $j \notin \text{Ancests}(i)$, $y_{i,j} = 0$
- $z_{i,l}$: boolean variable equal to 1 if link $l \in \text{path}[i \rightarrow r]$ used when i accesses server(i)
 - If $l \notin \text{path}[i \rightarrow r]$, $z_{i,l} = 0$

Objective function: $\sum_{j \in \mathcal{N}} sc_j x_j$

Linear program: variables

- x_j : boolean variable equal to 1 if j is a server (for one or several clients)
- $y_{i,j}$: boolean variable equal to 1 if $j = \text{server}(i)$
 - If $j \notin \text{Ancests}(i)$, $y_{i,j} = 0$
- $z_{i,l}$: boolean variable equal to 1 if link $l \in \text{path}[i \rightarrow r]$ used when i accesses server(i)
 - If $l \notin \text{path}[i \rightarrow r]$, $z_{i,l} = 0$

Objective function: $\sum_{j \in \mathcal{N}} sc_j x_j$

Linear program: constraints

- **Servers:** $\forall i \in \mathcal{C}, \sum_{j \in \text{Ancestors}(i)} y_{i,j} = 1$
- **Links:** $\forall i \in \mathcal{C}, z_{i,j \rightarrow \text{parent}(i)} = 1$
- **Conservation:** $\forall i \in \mathcal{C}, \forall l : j \rightarrow j' = \text{parent}(j) \in \text{path}[i \rightarrow r],$

$$z_{i,\text{succ}(l)} = z_{i,l} - y_{i,j'}$$
- **Server capacity:** $\forall j \in \mathcal{N}, \sum_{i \in \mathcal{C}} r_i y_{i,j} \leq W_j x_j$
- **Bandwidth limit:** $\forall l \in \mathcal{L}, \sum_{i \in \mathcal{C}} r_i z_{i,l} \leq \text{BW}_l$
- **QoS constraint:** $\forall i \in \mathcal{C}, \forall j \in \text{Ancestors}(i), \text{dist}(i, j) y_{i,j} \leq q_i$
- **Closest constraint:** $\forall i \in \mathcal{C}, \forall j \in \text{Ancestors}(i) \setminus \{r\},$

$$\forall i' \in \mathcal{C} \cap \text{subtree}(j), y_{i,j} + z_{i',j \rightarrow \text{parent}(j)} \leq 1$$

Linear program: constraints

- **Servers:** $\forall i \in \mathcal{C}, \sum_{j \in \text{Ancestors}(i)} y_{i,j} = 1$
- **Links:** $\forall i \in \mathcal{C}, z_{i,i \rightarrow \text{parent}(i)} = 1$
- **Conservation:** $\forall i \in \mathcal{C}, \forall l : j \rightarrow j' = \text{parent}(j) \in \text{path}[i \rightarrow r],$

$$z_{i,\text{succ}(l)} = z_{i,l} - y_{i,j'}$$
- **Server capacity:** $\forall j \in \mathcal{N}, \sum_{i \in \mathcal{C}} r_i y_{i,j} \leq W_j x_j$
- **Bandwidth limit:** $\forall l \in \mathcal{L}, \sum_{i \in \mathcal{C}} r_i z_{i,l} \leq \text{BW}_l$
- **QoS constraint:** $\forall i \in \mathcal{C}, \forall j \in \text{Ancestors}(i), \text{dist}(i, j) y_{i,j} \leq q_i$
- **Closest constraint:** $\forall i \in \mathcal{C}, \forall j \in \text{Ancestors}(i) \setminus \{r\},$

$$\forall i' \in \mathcal{C} \cap \text{subtree}(j), y_{i,j} + z_{i',j \rightarrow \text{parent}(j)} \leq 1$$

Linear program: constraints

- **Servers:** $\forall i \in \mathcal{C}, \sum_{j \in \text{Ancestors}(i)} y_{i,j} = 1$
- **Links:** $\forall i \in \mathcal{C}, z_{i,i \rightarrow \text{parent}(i)} = 1$
- **Conservation:** $\forall i \in \mathcal{C}, \forall l : j \rightarrow j' = \text{parent}(j) \in \text{path}[i \rightarrow r],$

$$z_{i,\text{succ}(l)} = z_{i,l} - y_{i,j'}$$
- **Server capacity:** $\forall j \in \mathcal{N}, \sum_{i \in \mathcal{C}} r_i y_{i,j} \leq W_j x_j$
- **Bandwidth limit:** $\forall l \in \mathcal{L}, \sum_{i \in \mathcal{C}} r_i z_{i,l} \leq \text{BW}_l$
- **QoS constraint:** $\forall i \in \mathcal{C}, \forall j \in \text{Ancestors}(i), \text{dist}(i,j) y_{i,j} \leq q_i$
- **Closest constraint:** $\forall i \in \mathcal{C}, \forall j \in \text{Ancestors}(i) \setminus \{r\},$

$$\forall i' \in \mathcal{C} \cap \text{subtree}(j), y_{i,j} + z_{i',j \rightarrow \text{parent}(j)} \leq 1$$

Linear program: constraints

- **Servers:** $\forall i \in \mathcal{C}, \sum_{j \in \text{Ancestors}(i)} y_{i,j} = 1$
- **Links:** $\forall i \in \mathcal{C}, z_{i,i \rightarrow \text{parent}(i)} = 1$
- **Conservation:** $\forall i \in \mathcal{C}, \forall l : j \rightarrow j' = \text{parent}(j) \in \text{path}[i \rightarrow r],$

$$z_{i,\text{succ}(l)} = z_{i,l} - y_{i,j'}$$
- **Server capacity:** $\forall j \in \mathcal{N}, \sum_{i \in \mathcal{C}} r_i y_{i,j} \leq W_j x_j$
- **Bandwidth limit:** $\forall l \in \mathcal{L}, \sum_{i \in \mathcal{C}} r_i z_{i,l} \leq \text{BW}_l$
- **QoS constraint:** $\forall i \in \mathcal{C}, \forall j \in \text{Ancestors}(i), \text{dist}(i, j) y_{i,j} \leq q_i$
- **Closest constraint:** $\forall i \in \mathcal{C}, \forall j \in \text{Ancestors}(i) \setminus \{r\},$

$$\forall i' \in \mathcal{C} \cap \text{subtree}(j), y_{i,j} + z_{i',j \rightarrow \text{parent}(j)} \leq 1$$

Linear program: constraints

- **Servers:** $\forall i \in \mathcal{C}, \sum_{j \in \text{Ancestors}(i)} y_{i,j} = 1$
- **Links:** $\forall i \in \mathcal{C}, z_{i,i \rightarrow \text{parent}(i)} = 1$
- **Conservation:** $\forall i \in \mathcal{C}, \forall l : j \rightarrow j' = \text{parent}(j) \in \text{path}[i \rightarrow r],$

$$z_{i,\text{succ}(l)} = z_{i,l} - y_{i,j'}$$
- **Server capacity:** $\forall j \in \mathcal{N}, \sum_{i \in \mathcal{C}} r_i y_{i,j} \leq W_j x_j$
- **Bandwidth limit:** $\forall l \in \mathcal{L}, \sum_{i \in \mathcal{C}} r_i z_{i,l} \leq \text{BW}_l$
- **QoS constraint:** $\forall i \in \mathcal{C}, \forall j \in \text{Ancestors}(i), \text{dist}(i, j) y_{i,j} \leq q_i$
- **Closest constraint:** $\forall i \in \mathcal{C}, \forall j \in \text{Ancestors}(i) \setminus \{r\},$

$$\forall i' \in \mathcal{C} \cap \text{subtree}(j), y_{i,j} + z_{i',j \rightarrow \text{parent}(j)} \leq 1$$

Linear program: constraints

- **Servers:** $\forall i \in \mathcal{C}, \sum_{j \in \text{Ancestors}(i)} y_{i,j} = 1$
- **Links:** $\forall i \in \mathcal{C}, z_{i,i \rightarrow \text{parent}(i)} = 1$
- **Conservation:** $\forall i \in \mathcal{C}, \forall l : j \rightarrow j' = \text{parent}(j) \in \text{path}[i \rightarrow r],$
 $z_{i,\text{succ}(l)} = z_{i,l} - y_{i,j'}$
- **Server capacity:** $\forall j \in \mathcal{N}, \sum_{i \in \mathcal{C}} r_i y_{i,j} \leq W_j x_j$
- **Bandwidth limit:** $\forall l \in \mathcal{L}, \sum_{i \in \mathcal{C}} r_i z_{i,l} \leq \text{BW}_l$
- **QoS constraint:** $\forall i \in \mathcal{C}, \forall j \in \text{Ancestors}(i), \text{dist}(i, j) y_{i,j} \leq q_i$
- **Closest constraint:** $\forall i \in \mathcal{C}, \forall j \in \text{Ancestors}(i) \setminus \{r\},$
 $\forall i' \in \mathcal{C} \cap \text{subtree}(j), y_{i,j} + z_{i',j \rightarrow \text{parent}(j)} \leq 1$

Linear program: constraints

- **Servers:** $\forall i \in \mathcal{C}, \sum_{j \in \text{Ancestors}(i)} y_{i,j} = 1$
- **Links:** $\forall i \in \mathcal{C}, z_{i,i \rightarrow \text{parent}(i)} = 1$
- **Conservation:** $\forall i \in \mathcal{C}, \forall l : j \rightarrow j' = \text{parent}(j) \in \text{path}[i \rightarrow r],$

$$z_{i,\text{succ}(l)} = z_{i,l} - y_{i,j'}$$
- **Server capacity:** $\forall j \in \mathcal{N}, \sum_{i \in \mathcal{C}} r_i y_{i,j} \leq W_j x_j$
- **Bandwidth limit:** $\forall l \in \mathcal{L}, \sum_{i \in \mathcal{C}} r_i z_{i,l} \leq \text{BW}_l$
- **QoS constraint:** $\forall i \in \mathcal{C}, \forall j \in \text{Ancestors}(i), \text{dist}(i, j) y_{i,j} \leq q_i$
- **Closest constraint:** $\forall i \in \mathcal{C}, \forall j \in \text{Ancestors}(i) \setminus \{r\},$

$$\forall i' \in \mathcal{C} \cap \text{subtree}(j), y_{i,j} + z_{i',j \rightarrow \text{parent}(j)} \leq 1$$

Multiple formulation

Multiple

- Similar formulation, with
 - $y_{i,j}$: integer variable = nb requests from client i processed by node j
 - $z_{i,l}$: integer variable = nb requests flowing through link l
- Constraints are slightly modified

An ILP-based lower bound

- **Solving over the rationals:** solution for all practical values of the problem size
 - Not very precise bound
 - *Upwards/Closest* equivalent to *Multiple* when solved over the rationals
- **Integer solving:** limitation to $s \leq 50$ nodes and clients
- **Mixed bound** obtained by solving the *Upwards* formulation over the rational and imposing only the x_j being integers
 - Resolution for problem sizes $s \leq 400$
 - **Improved bound:** if a server is used only at 50% of its capacity, the cost of placing a replica at this node is not halved as it would be with $x_j = 0.5$.

An ILP-based lower bound

- **Solving over the rationals:** solution for all practical values of the problem size
 - Not very precise bound
 - *Upwards/Closest* equivalent to *Multiple* when solved over the rationals
- **Integer solving:** limitation to $s \leq 50$ nodes and clients
- **Mixed bound** obtained by solving the *Upwards* formulation over the rational and imposing only the x_j being integers
 - Resolution for problem sizes $s \leq 400$
 - **Improved bound:** if a server is used only at 50% of its capacity, the cost of placing a replica at this node is not halved as it would be with $x_j = 0.5$.

An ILP-based lower bound

- **Solving over the rationals**: solution for all practical values of the problem size
 - Not very precise bound
 - *Upwards/Closest* equivalent to *Multiple* when solved over the rationals
- **Integer solving**: limitation to $s \leq 50$ nodes and clients
- **Mixed bound** obtained by solving the *Upwards* formulation over the rational and imposing only the x_j being integers
 - Resolution for problem sizes $s \leq 400$
 - **Improved bound**: if a server is used only at 50% of its capacity, the cost of placing a replica at this node is not halved as it would be with $x_j = 0.5$.

Outline

- 1 Framework
- 2 Access policies
- 3 Complexity results
- 4 Linear programming formulation
- 5 Heuristics for the REPLICA COST problem**
- 6 Experiments
- 7 Extensions
- 8 Conclusion

Heuristics

- Polynomial heuristics for the REPLICa COST problem
 - Heterogeneous platforms
 - No QoS nor bandwidth constraints
- Experimental assessment of the relative performance of the three policies
- Traversals of the tree, bottom-up or top-down
- In the worst case complexity $O(s^2)$, where $s = |\mathcal{C}| + |\mathcal{N}|$ is the problem size

Heuristics

- Polynomial heuristics for the REPLICa COST problem
 - Heterogeneous platforms
 - No QoS nor bandwidth constraints
- Experimental assessment of the relative performance of the three policies
- Traversals of the tree, bottom-up or top-down
- In the worst case complexity $O(s^2)$, where $s = |\mathcal{C}| + |\mathcal{N}|$ is the problem size

Heuristics

- Polynomial heuristics for the REPLICa COST problem
 - Heterogeneous platforms
 - No QoS nor bandwidth constraints
- Experimental assessment of the relative performance of the three policies
- Traversals of the tree, bottom-up or top-down
- In the worst case complexity $O(s^2)$, where $s = |\mathcal{C}| + |\mathcal{N}|$ is the problem size

Heuristics for *Closest*

- Closest Top Down All **CTDA**
 - Breadth-first traversal of the tree
 - When a node can process the requests of all the clients in its subtree, node chosen as a server and exploration of the subtree stopped
 - Procedure called until no more servers are added
 - Choosing n_2, n_4 and then n_1

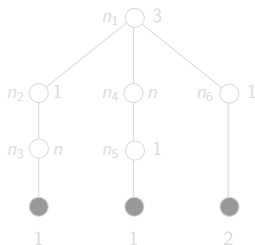

Heuristics for *Closest*

- Closest Top Down All **CTDA**
 - Breadth-first traversal of the tree
 - When a node can process the requests of all the clients in its subtree, node chosen as a server and exploration of the subtree stopped
 - Procedure called until no more servers are added
 - Choosing n_2 , n_4 and then n_1

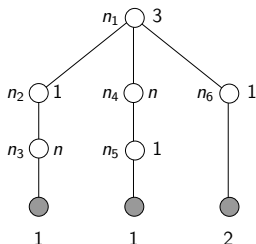

Heuristics for *Closest*

- Closest Top Down All **CTDA**
- Closest Top Down Largest First **CTDLF**

Heuristics for *Closest*

- Closest Top Down All **CTDA**
- Closest Top Down Largest First **CTDLF**
 - Traversal of the tree, treating subtrees that contains most requests first
 - When a node can process the requests of all the clients in its subtree, node chosen as a server and traversal stopped
 - Procedure called until no more servers are added
 - Choosing n_2 and then n_1

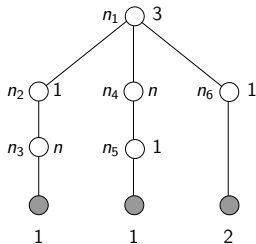

Heuristics for *Closest*

- Closest Top Down All **CTDA**
- Closest Top Down Largest First **CTDLF**
- Closest Bottom Up **CBU**

Heuristics for *Closest*

- Closest Top Down All **CTDA**
- Closest Top Down Largest First **CTDLF**
- Closest Bottom Up **CBU**
 - Bottom-up traversal of the tree
 - When a node can process the requests of all the clients in its subtree, node chosen as a server
 - Choosing n_3, n_5, n_1

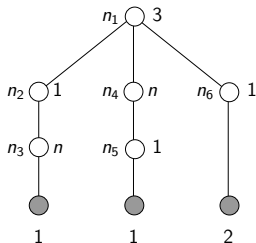

Heuristics for *Upwards*

- Upwards Top Down **UTD**
 - 2-pass algorithm
 - Select first saturating nodes, then extra nodes
 - Choosing n_2 (for c_1) and in second pass n_1 (for c_2, c_3)

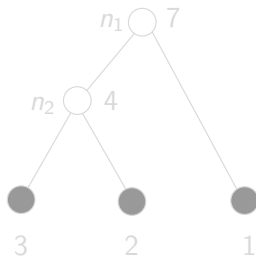

Heuristics for *Upwards*

- Upwards Top Down **UTD**
 - 2-pass algorithm
 - Select first saturating nodes, then extra nodes
 - Choosing n_2 (for c_1) and in second pass n_1 (for c_2, c_3)

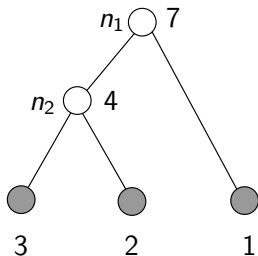

Heuristics for *Upwards*

- Upwards Top Down **UTD**
- Upwards Big Client First **UBCF**

Heuristics for *Upwards*

- Upwards Top Down **UTD**
- Upwards Big Client First **UBCF**
 - Sorting clients by decreasing request numbers, and finding the server of minimal available capacity to process its requests.
 - Choosing n_2 for c_1 , n_1 for c_2 and n_1 for c_3

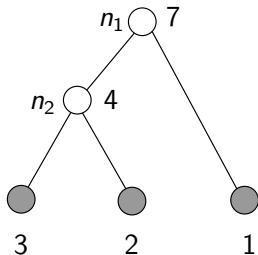

Heuristics for *Multiple*

- A top-down and a bottom-up heuristic in 2-passes (**MTD, MBU**)
- A greedy heuristic **MG**, similar to Pass 3 of the polynomial algorithm for *Multiple*/Homogeneous: fill all servers as much as possible in a bottom-up fashion

Heuristics for *Multiple*

- A top-down and a bottom-up heuristic in 2-passes (**MTD**, **MBU**)
- A greedy heuristic **MG**, similar to Pass 3 of the polynomial algorithm for *Multiple*/Homogeneous: fill all servers as much as possible in a bottom-up fashion

Heuristics for *Multiple*

- A top-down and a bottom-up heuristic in 2-passes (**MTD, MBU**)
- A greedy heuristic **MG**, similar to Pass 3 of the polynomial algorithm for *Multiple*/Homogeneous: fill all servers as much as possible in a bottom-up fashion

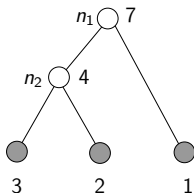

- MG affects 4 requests to n_2 , and then the remaining 2 requests to n_1

Heuristics for *Multiple*

- A top-down and a bottom-up heuristic in 2-passes (**MTD, MBU**)
- A greedy heuristic **MG**, similar to Pass 3 of the polynomial algorithm for *Multiple*/Homogeneous: fill all servers as much as possible in a bottom-up fashion

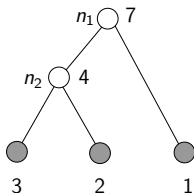

- MG affects 4 requests to n_2 , and then the remaining 2 requests to n_1
- **CTDLF better on this example:** selects n_1 only

Heuristics for *Multiple*

- A top-down and a bottom-up heuristic in 2-passes (**MTD, MBU**)
- A greedy heuristic **MG**, similar to Pass 3 of the polynomial algorithm for *Multiple*/Homogeneous: fill all servers as much as possible in a bottom-up fashion
- Heuristic MixedBest **MB** which picks up **best result over all heuristics**: solution for the *Multiple* policy

Outline

- 1 Framework
- 2 Access policies
- 3 Complexity results
- 4 Linear programming formulation
- 5 Heuristics for the REPLICATOR COST problem
- 6 Experiments**
- 7 Extensions
- 8 Conclusion

Plan of experiments

- Assess the impact of the different **access policies**
- Assess the performance of the **polynomial heuristics**
- Important parameter:

$$\lambda = \frac{\sum_{i \in \mathcal{C}} r_i}{\sum_{j \in \mathcal{N}} W_j}$$

- 30 trees for each $\lambda = 0.1, 0.2, \dots, 0.9$
- Problem size $s = |\mathcal{C}| + |\mathcal{N}|$ such that $15 \leq s \leq 400$
- Computation of the LP lower bound for each tree

Plan of experiments

- Assess the impact of the different **access policies**
- Assess the performance of the **polynomial heuristics**
- Important parameter:

$$\lambda = \frac{\sum_{i \in \mathcal{C}} r_i}{\sum_{j \in \mathcal{N}} W_j}$$

- **30 trees** for each $\lambda = 0.1, 0.2, \dots, 0.9$
- **Problem size** $s = |\mathcal{C}| + |\mathcal{N}|$ such that $15 \leq s \leq 400$
- Computation of the **LP lower bound** for each tree

Results - Percentage of success

- Number of solutions for each lambda and each heuristic
- No LP solution → No solution for any heuristic
- Homogeneous case

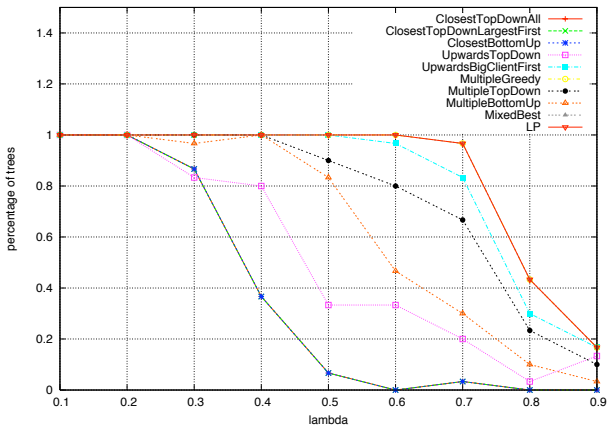

Results - Percentage of success

- Heterogeneous trees: similar results

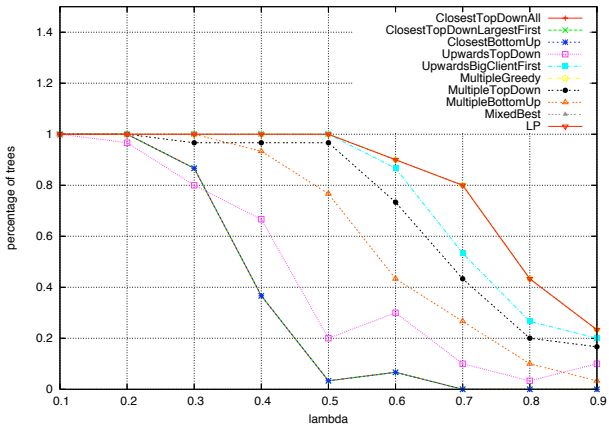

- Striking impact of new policies
- MG and MB always find the solution

Results - Percentage of success

- Heterogeneous trees: similar results

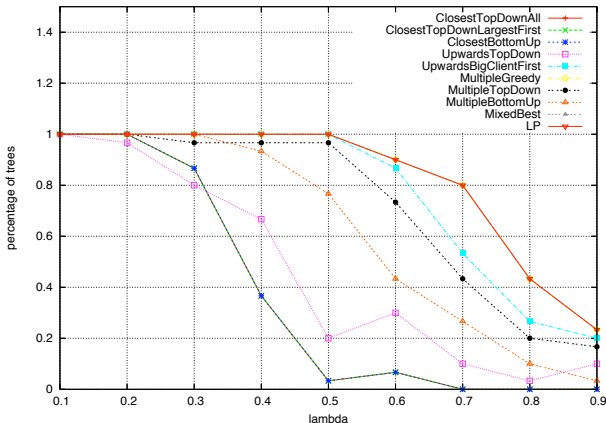

- Striking impact of new policies
- MG and MB always find the solution

Results - Percentage of success

- Heterogeneous trees: similar results

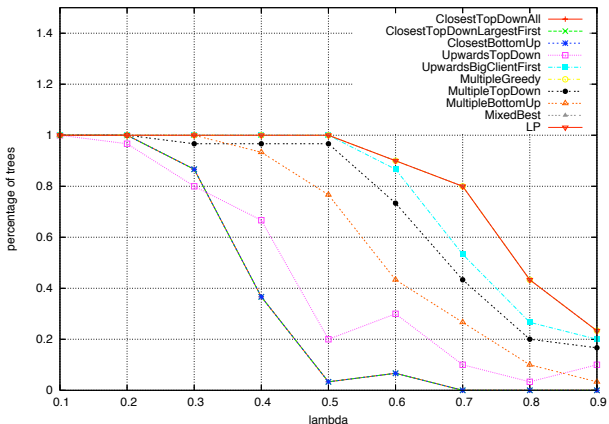

- Striking impact of new policies
- MG and MB always find the solution

Results - Solution cost

- Distance of the result (in terms of **replica cost**) of the heuristic to the lower bound
- T_λ : subset of trees with a solution
- Relative cost:

$$rcost = \frac{1}{|T_\lambda|} \sum_{t \in T_\lambda} \frac{cost_{LP}(t)}{cost_h(t)}$$

- $cost_{LP}(t)$: lower bound cost on tree t
- $cost_h(t)$: heuristic cost on tree t ; $cost_h(t) = +\infty$ if h did not find any solution

Results - Solution cost

- Distance of the result (in terms of **replica cost**) of the heuristic to the lower bound
- T_λ : subset of trees with a solution
- Relative cost:

$$rcost = \frac{1}{|T_\lambda|} \sum_{t \in T_\lambda} \frac{cost_{LP}(t)}{cost_h(t)}$$

- $cost_{LP}(t)$: lower bound cost on tree t
- $cost_h(t)$: heuristic cost on tree t ; $cost_h(t) = +\infty$ if h did not find any solution

Results - Solution cost

● Homogeneous results

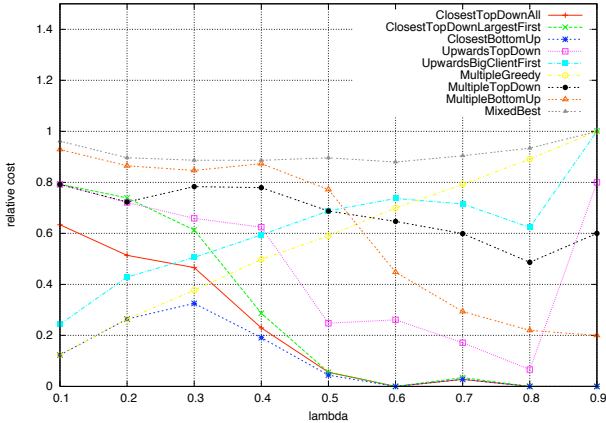

Results - Solution cost

- Heterogeneous results - similar to the homogeneous case

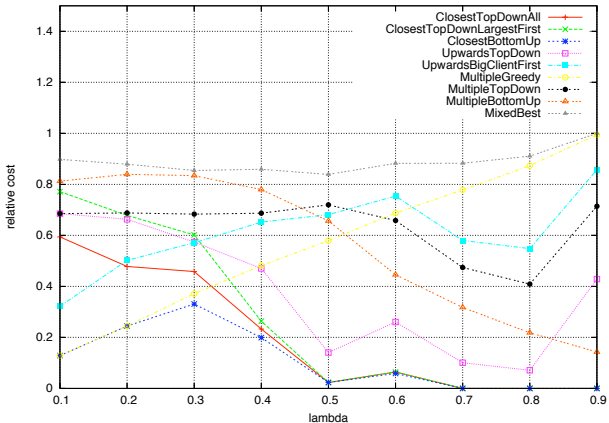

Summary

- Striking effect of new policies: many more solutions to the REPLICA PLACEMENT problem
- *Multiple* \geq *Upwards* \geq *Closest*: hierarchy observed within our heuristics
- Best *Multiple* heuristic (MB) always at 85% of the lower bound: satisfactory result

Outline

- 1 Framework
- 2 Access policies
- 3 Complexity results
- 4 Linear programming formulation
- 5 Heuristics for the REPLICAS COST problem
- 6 Experiments
- 7 Extensions**
- 8 Conclusion

Extensions

- Simplified problem instance for this work
- Possible generalizations:
 - Several objects
 - More complex objective function

Extensions - Several objects

- We considered a single object: all replicas are identical
- Different types of objects need to be accessed: clients have requests of different types
- New parameters:
 - Requests per object r_i^k , and $q_i^{(k)}$
 - Size of the object, computation time involved, storage cost, ...
- Constraints and objective function slightly modified
- Constraints/Objective function add up linearly for different objects: LP-formulation easily extended.
- Efficient heuristics in this case: challenging problem

Extensions - Several objects

- We considered a single object: all replicas are identical
- Different types of objects need to be accessed: clients have requests of different types
- New parameters:
 - Requests per object r_i^k , and $q_i^{(k)}$
 - Size of the object, computation time involved, storage cost, ...
- Constraints and objective function slightly modified
- Constraints/Objective function add up linearly for different objects: LP-formulation easily extended.
- Efficient heuristics in this case: challenging problem

Extensions - Several objects

- We considered a single object: all replicas are identical
- Different types of objects need to be accessed: clients have requests of different types
- New parameters:
 - Requests per object r_i^k , and $q_i^{(k)}$
 - Size of the object, computation time involved, storage cost, ...
- Constraints and objective function slightly modified
- Constraints/Objective function add up linearly for different objects: LP-formulation easily extended.
- Efficient heuristics in this case: challenging problem

Extensions - Several objects

- We considered a single object: all replicas are identical
- Different types of objects need to be accessed: clients have requests of different types
- New parameters:
 - Requests per object r_i^k , and $q_i^{(k)}$
 - Size of the object, computation time involved, storage cost, ...
- Constraints and objective function slightly modified
- Constraints/Objective function add up linearly for different objects: LP-formulation easily extended.
- **Efficient heuristics in this case: challenging problem**

Extensions - Objective function

Cost of replica – What we considered in this work

Communication cost – This cost is the *read* cost

Update cost – The *write* cost is the extra cost due to an update of the replicas

Linear combination – A quite general objective function can be obtained by a linear combination of the three different costs

$$\alpha \sum_{\text{servers, objects}} \text{replica cost} + \beta \sum_{\text{requests}} \text{read cost} + \gamma \sum_{\text{updates}} \text{write cost}$$

Efficient heuristics in this case: challenging problem

Extensions - Objective function

Cost of replica – What we considered in this work

Communication cost – This cost is the *read* cost

Update cost – The *write* cost is the extra cost due to an update of the replicas

Linear combination – A quite general objective function can be obtained by a linear combination of the three different costs

$$\alpha \sum_{\text{servers, objects}} \text{replica cost} + \beta \sum_{\text{requests}} \text{read cost} + \gamma \sum_{\text{updates}} \text{write cost}$$

Efficient heuristics in this case: challenging problem

Outline

- 1 Framework
- 2 Access policies
- 3 Complexity results
- 4 Linear programming formulation
- 5 Heuristics for the REPLICAS COST problem
- 6 Experiments
- 7 Extensions
- 8 Conclusion**

Related work

- Several papers on replica placement, but...
- ...all consider only the *Closest* policy
- REPLICAS PLACEMENT in a general graph is NP-complete
- Wolfson and Milo: impact of the *write* cost, use of a minimum spanning tree for updates. Tree networks: polynomial solution
- Cidon et al (multiple objects) and Liu et al (QoS constraints): polynomial algorithms for homogeneous networks.
- Kalpakis et al: NP-completeness of a variant with bidirectional links (requests served by any node in the tree)
- Karlsson et al: comparison of different objective functions and several heuristics. No QoS, but several other constraints.
- Tang et al: real QoS constraints
- Rodolakis et al: *Multiple* policy but in a very different context

Related work

- Several papers on replica placement, but...
- ...all consider only the *Closest* policy
- REPLICAS PLACEMENT in a general graph is NP-complete
- Wolfson and Milo: impact of the *write* cost, use of a minimum spanning tree for updates. Tree networks: polynomial solution
- Cidon et al (multiple objects) and Liu et al (QoS constraints): polynomial algorithms for homogeneous networks.
- Kalpakis et al: NP-completeness of a variant with bidirectional links (requests served by any node in the tree)
- Karlsson et al: comparison of different objective functions and several heuristics. No QoS, but several other constraints.
- Tang et al: real QoS constraints
- Rodolakis et al: *Multiple* policy but in a very different context

Related work

- Several papers on replica placement, but...
- ...all consider only the *Closest* policy
- REPLICAS PLACEMENT in a general graph is NP-complete
- Wolfson and Milo: impact of the *write* cost, use of a minimum spanning tree for updates. Tree networks: polynomial solution
- Cidon et al (multiple objects) and Liu et al (QoS constraints): polynomial algorithms for homogeneous networks.
- Kalpakis et al: NP-completeness of a variant with bidirectional links (requests served by any node in the tree)
- Karlsson et al: comparison of different objective functions and several heuristics. No QoS, but several other constraints.
- Tang et al: real QoS constraints
- Rodolakis et al: *Multiple* policy but in a very different context

Conclusion

- Introduction of two new policies for the REPLICa PLACEMENT problem
- *Upwards* and *Multiple*: natural variants of the standard *Closest* approach → **surprising they have not already been considered**

Theoretical side – Complexity of each policy, for homogeneous and heterogeneous platforms

Practical side

- Design of several heuristics for each policy
- Comparison of their performance
- Striking impact of the policy on the result
- Use of a LP-based lower bound to assess the absolute performance, which turns out to be quite good.

Conclusion

- Introduction of two new policies for the REPLICA PLACEMENT problem
- *Upwards* and *Multiple*: natural variants of the standard *Closest* approach → surprising they have not already been considered

Theoretical side – Complexity of each policy, for homogeneous and heterogeneous platforms

Practical side

- Design of several heuristics for each policy
- Comparison of their performance
- Striking impact of the policy on the result
- Use of a LP-based lower bound to assess the absolute performance, which turns out to be quite good.

Future work

Short term

- More simulations for the `REPLICA COST` problem: shape of the trees, distribution law of the requests, degree of heterogeneity of the platforms
- Designing heuristics for more general instances of the `REPLICA PLACEMENT` problem (QoS and bandwidth constraints): these constraints may lower the difference between policies

Longer term

- Consider the problem with several object types
- Extension with more complex objective functions

Still a lot of challenging algorithmic problems 😊

Future work

Short term

- More simulations for the `REPLICA COST` problem: shape of the trees, distribution law of the requests, degree of heterogeneity of the platforms
- Designing heuristics for more general instances of the `REPLICA PLACEMENT` problem (QoS and bandwidth constraints): these constraints may lower the difference between policies

Longer term

- Consider the problem with several object types
- Extension with more complex objective functions

Still a lot of challenging algorithmic problems 😊