

# Homomorphisms of signed graphs

Éric SOPENA  
LaBRI, Bordeaux University  
France

# Homomorphisms of signed graphs

Éric SOPENA

LaBRI, Bordeaux University

France



*based on joint work with  
Reza Naserasr (Orsay, France)  
and Edita Rollová (Plzeň, Czech Republic)*

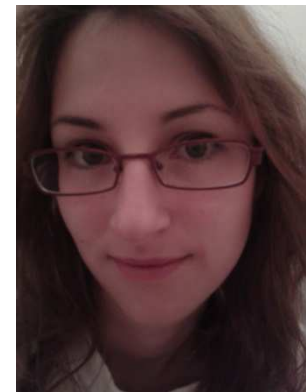

CID 2013 - September 15-20, 2013, Szklarska Poręba, Poland

# Motivation

# Motivation

Graph colouring

# Motivation

## Graph colouring

### Brook's Theorem

*Every connected graph  $G$  which is neither an odd cycle nor a complete graph is  $\Delta(G)$ -colourable.*

# Motivation

Graph colouring

Brook's Theorem

*Every planar graph is 4-colourable.*

Four-Colour  
Theorem

# Motivation

## Graph colouring

Brook's Theorem

*If  $G$  has no  $K_n$  as a minor,  
then  $G$  is  $(n-1)$ -colourable*

Four-Colour  
Theorem

Hadwiger's  
conjecture

# Motivation

*Every connected graph  $G$  which is neither an odd cycle nor a complete graph is  $\Delta(G)$ -colourable.*

*Every planar graph is 4-colourable.*

*If  $G$  has no  $K_n$  as a minor, then  $G$  is  $(n-1)$ -colourable*

$\Rightarrow$  Upper bounds on the chromatic number (NP-hard to compute) in terms of parameters or properties easy to compute or verify...



# Motivation

*Every connected graph  $G$  which is neither an odd cycle nor a complete graph is  $\Delta(G)$ -colourable.*

*Every planar graph is 4-colourable.*

*If  $G$  has no  $K_n$  as a minor, then  $G$  is  $(n-1)$ -colourable*

$\Rightarrow$  Upper bounds on the chromatic number (NP-hard to compute) in terms of parameters or properties easy to compute or verify...

But none of these bounds is "good" for bipartite graphs...

# Motivation

*Every connected graph  $G$  which is neither an odd cycle nor a complete graph is  $\Delta(G)$ -colourable.*

*Every planar graph is 4-colourable.*

*If  $G$  has no  $K_n$  as a minor, then  $G$  is  $(n-1)$ -colourable*

⇒ Upper bounds on the chromatic number (NP-hard to compute) in terms of parameters or properties easy to compute or verify...

But none of these bounds is "good" for bipartite graphs...

Signed graphs may help to get "better" results...

# Motivation

Since the 1950's, several theories have been extended from graphs to signed graphs (minors, nowhere-zero flows, colouring, ...).

# Motivation

Since the 1950's, several theories have been extended from graphs to signed graphs (minors, nowhere-zero flows, colouring, ...).

## Our goal

- Investigate relations between minors and homomorphisms of signed graphs,

# Motivation

Since the 1950's, several theories have been extended from graphs to signed graphs (minors, nowhere-zero flows, colouring, ...).

## Our goal

- Investigate relations between minors and homomorphisms of signed graphs,
- Extend colouring (or homomorphism) results from graphs to signed graphs,

# Motivation

Since the 1950's, several theories have been extended from graphs to signed graphs (minors, nowhere-zero flows, colouring, ...).

## Our goal

- Investigate relations between minors and homomorphisms of signed graphs,
- Extend colouring (or homomorphism) results from graphs to signed graphs,
- ...with a special focus on minor-closed families of graphs (e.g. planar graphs).

# Outline

- Preliminaries
- Signed graphs
- Odd signed graphs
- Signed bipartite graphs
- Homomorphisms to signed projective cubes
- Chromatic number of signed graphs

# Preliminaries



# Vertex Colouring

A (proper) **k-vertex-colouring** of a graph  $G$  is a mapping  $c : V(G) \rightarrow \{1, 2, \dots, k\}$  such that every two *adjacent vertices* are assigned *distinct colours*.

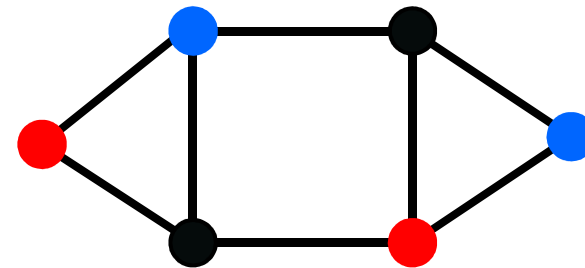
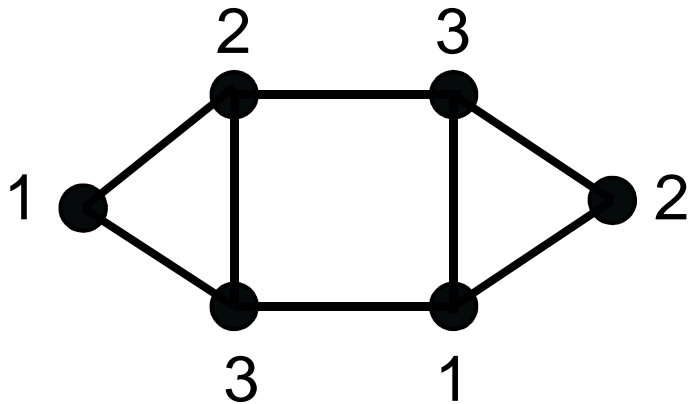

# Vertex Colouring

A (proper) **k-vertex-colouring** of a graph  $G$  is a mapping  $c : V(G) \rightarrow \{1, 2, \dots, k\}$  such that every two *adjacent vertices* are assigned *distinct colours*.

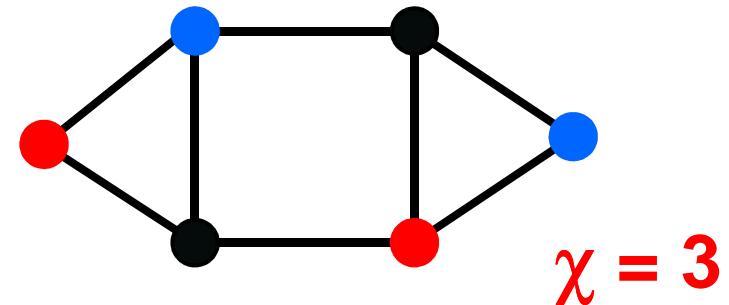
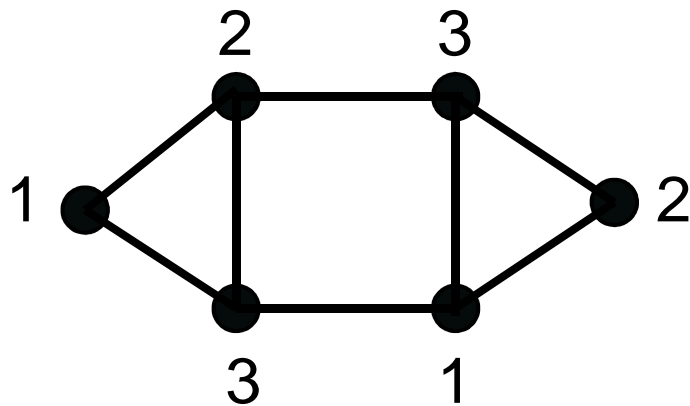

The **chromatic number**  $\chi(G)$  of  $G$  is the smallest  $k$  for which  $G$  has a  $k$ -vertex-colouring.

# Graph homomorphisms

A **homomorphism** from  $G$  to  $H$  is a mapping  $h : V(G) \rightarrow V(H)$  such that :

$$xy \in E(G) \Rightarrow h(x)h(y) \in E(H)$$

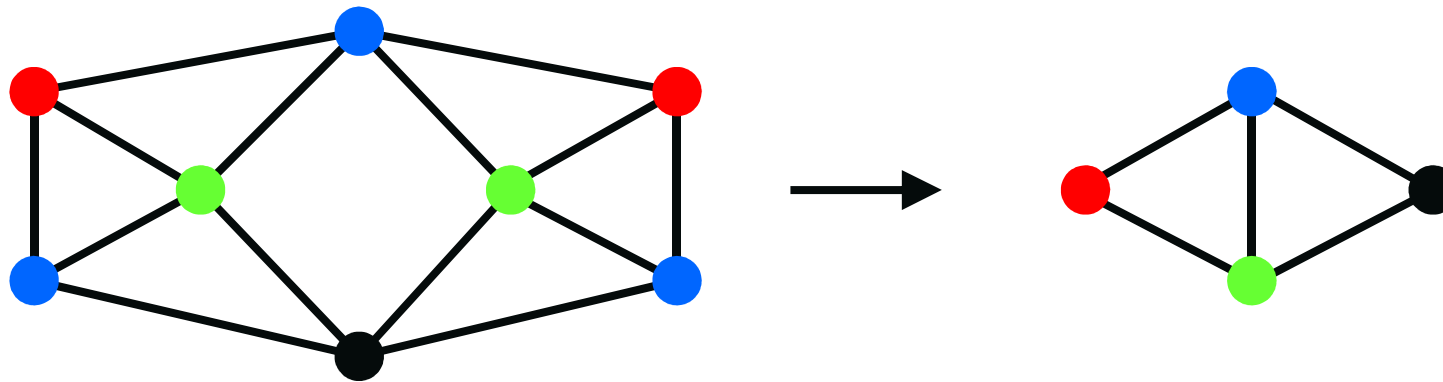

# Graph homomorphisms

A **homomorphism** from  $G$  to  $H$  is a mapping  $h : V(G) \rightarrow V(H)$  such that :

$$xy \in E(G) \Rightarrow h(x)h(y) \in E(H)$$

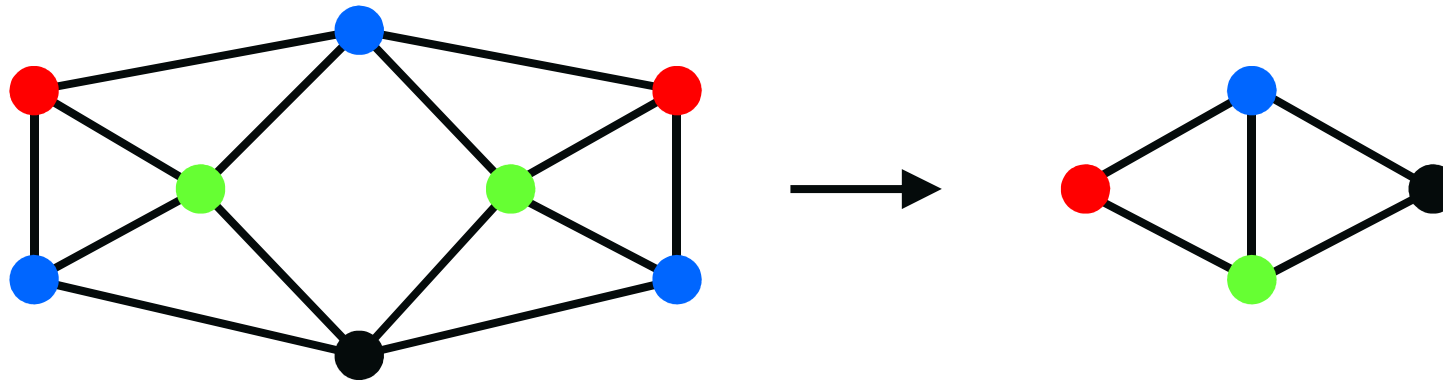

## Notation.

$G \rightarrow H$  : there exists a homomorphism from  $G$  to  $H$

# Homomorphisms and colourings

A  $k$ -vertex-colouring of  $G$  is nothing but a *homomorphism* from  $G$  to  $K_k$ , the *complete graph* on  $k$  vertices.

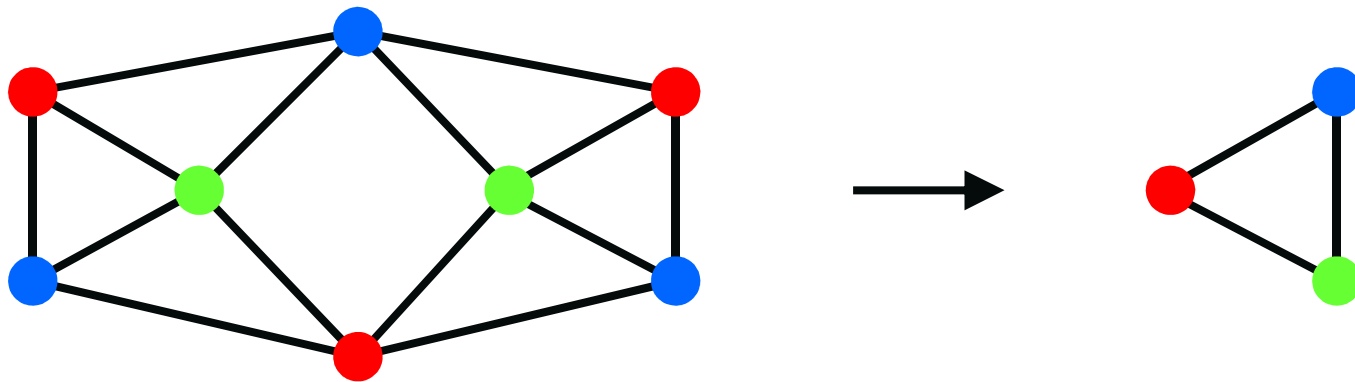

# Homomorphisms and colourings

A  $k$ -vertex-colouring of  $G$  is nothing but a *homomorphism* from  $G$  to  $K_k$ , the *complete graph* on  $k$  vertices.

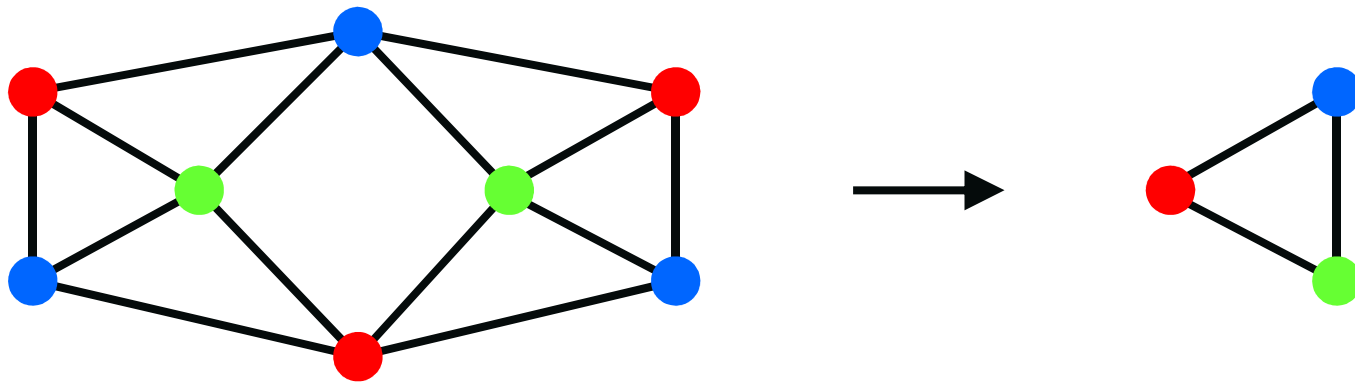

## Remark.

$\chi(G) = k$  if and only if  $G \rightarrow K_k$  and  $G \not\rightarrow K_{k-1}$

# Homomorphisms and colourings

A  $k$ -vertex-colouring of  $G$  is nothing but a *homomorphism* from  $G$  to  $K_k$ , the *complete graph* on  $k$  vertices.

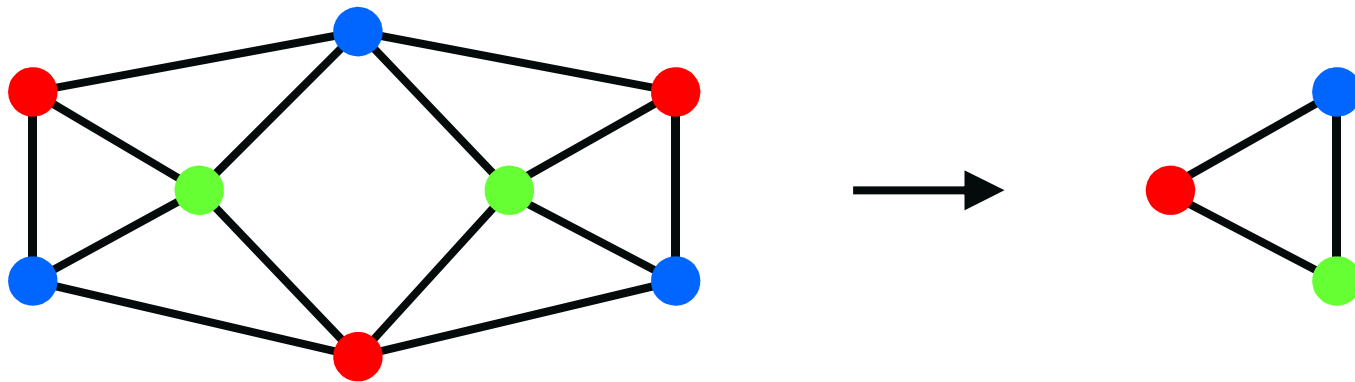

*The chromatic number  $\chi(G)$  of  $G$  can equivalently be defined as the smallest order of a (complete) graph  $H$  such that  $G \rightarrow H$ .*

# Graph minors

A graph  $H$  is a **minor** of  $G$  if  $H$  can be obtained from  $G$  by deleting vertices, deleting edges and contracting edges.



# Graph minors

A graph  $H$  is a **minor** of  $G$  if  $H$  can be obtained from  $G$  by deleting vertices, deleting edges and contracting edges.

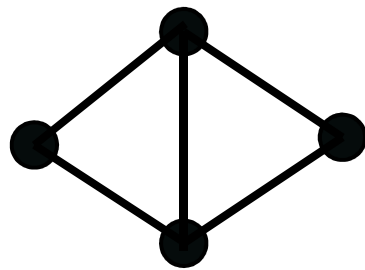

is a minor of

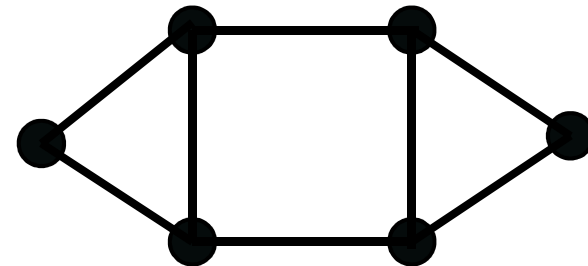

# Graph minors

A graph  $H$  is a **minor** of  $G$  if  $H$  can be obtained from  $G$  by deleting vertices, deleting edges and contracting edges.

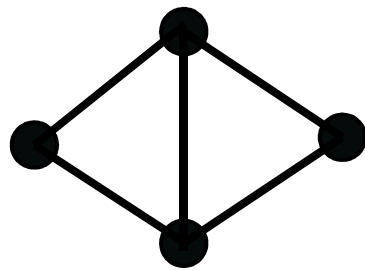

is a minor of

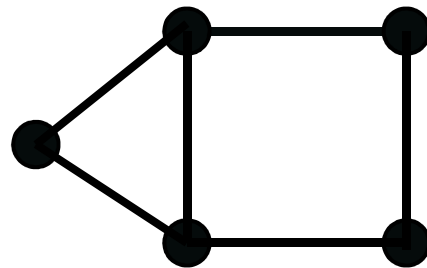
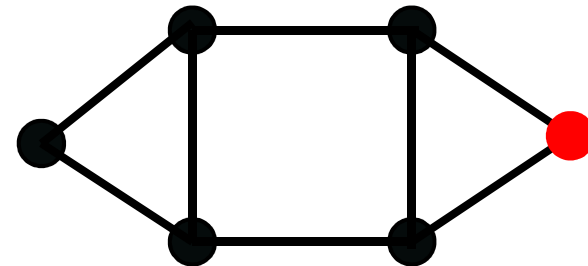

# Graph minors

A graph  $H$  is a **minor** of  $G$  if  $H$  can be obtained from  $G$  by deleting vertices, deleting edges and contracting edges.

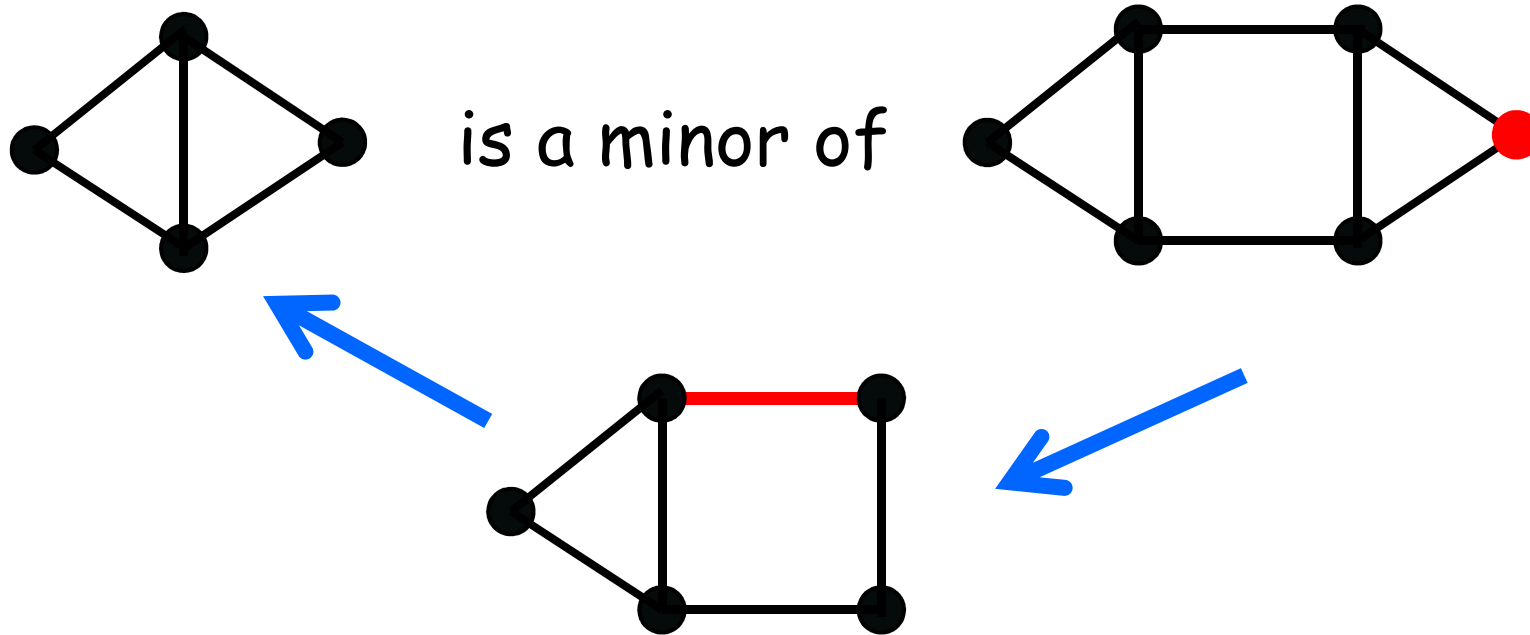

# Hadwiger's Conjecture

**Hadwiger's Conjecture (1943).**

If a graph  $G$  has no  $K_n$  as a minor, then  $G$  is  $(n-1)$ -colourable.



# Hadwiger's Conjecture

**Hadwiger's Conjecture (1943).**

If a graph  $G$  has no  $K_n$  as a minor,  
then  $G$  is  $(n-1)$ -colourable.



- $n = 2$ : if  $G$  has no edge, then  $G$  is 1-colourable.

# Hadwiger's Conjecture

**Hadwiger's Conjecture (1943).**

If a graph  $G$  has no  $K_n$  as a minor, then  $G$  is  $(n-1)$ -colourable.



- $n = 2$ : if  $G$  has no edge, then  $G$  is 1-colourable.
- $n = 3$ : if  $G$  has no cycle ( $G$  is a forest), then  $G$  is 2-colourable.

# Hadwiger's Conjecture

**Hadwiger's Conjecture (1943).**

If a graph  $G$  has no  $K_n$  as a minor, then  $G$  is  $(n-1)$ -colourable.



- $n = 2$ : if  $G$  has no edge, then  $G$  is 1-colourable.
- $n = 3$ : if  $G$  has no cycle ( $G$  is a forest), then  $G$  is 2-colourable.
- $n = 4$ : if  $G$  is a partial 2-tree, then  $G$  is 3-colourable.

# Hadwiger's Conjecture

**Hadwiger's Conjecture (1943).**

If a graph  $G$  has no  $K_n$  as a minor,  
then  $G$  is  $(n-1)$ -colourable.



- $n = 5$ : *equivalent to the Four-Colour Theorem (Wagner, 1937).*



# Hadwiger's Conjecture

**Hadwiger's Conjecture (1943).**

If a graph  $G$  has no  $K_n$  as a minor,  
then  $G$  is  $(n-1)$ -colourable.



- $n = 5$ : *equivalent to the Four-Colour Theorem (Wagner, 1937).*
- $n = 6$ : Robertson, Seymour & Thomas (1993).

# Hadwiger's Conjecture

**Hadwiger's Conjecture (1943).**

If a graph  $G$  has no  $K_n$  as a minor,  
then  $G$  is  $(n-1)$ -colourable.



- $n = 5$ : *equivalent to the Four-Colour Theorem (Wagner, 1937).*
- $n = 6$ : Robertson, Seymour & Thomas (1993).
- $n \geq 7$ : open...

# Signed graphs

# Signified graphs

A **signified graph** is a pair  $(G, \Sigma)$  where  $G$  is a graph and  $\Sigma$  a *signature* on  $G$ , that is a subset of  $E(G)$ . Edges belonging to  $\Sigma$  are *negative* edges, while other edges are *positive* edges.

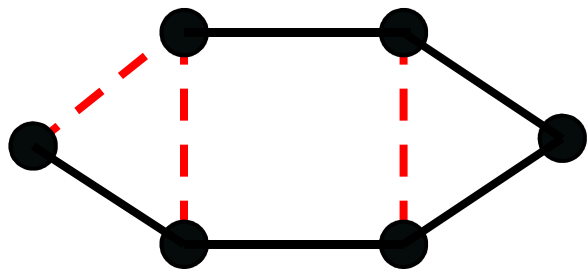

positive edge

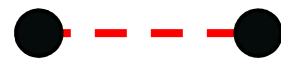

negative edge

# Signified graphs

A **signified graph** is a pair  $(G, \Sigma)$  where  $G$  is a graph and  $\Sigma$  a *signature* on  $G$ , that is a subset of  $E(G)$ . Edges belonging to  $\Sigma$  are *negative* edges, while other edges are *positive* edges.

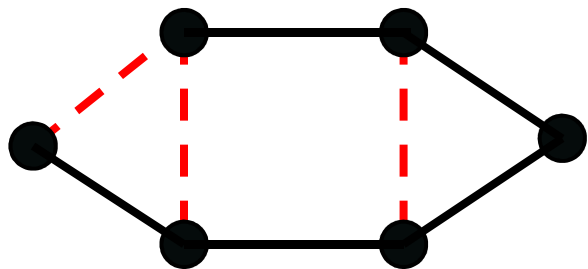

positive edge



negative edge

**Frank Harary.** On the notion of balance of a signed graph.  
*Michigan Math. J.* 2(2):143-146 (1954). (*Social Psychology: "like" and "dislike" relations in social networks.*)



# Resigning

Let  $(G, \Sigma)$  be a signified graph and  $v$  a vertex of  $V(G)$ . By *resigning at  $v$* , we mean changing the sign of every edge incident to  $v$ .

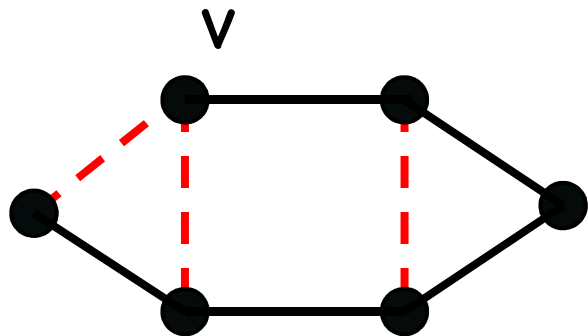

# Resigning

Let  $(G, \Sigma)$  be a signified graph and  $v$  a vertex of  $V(G)$ . By *resigning at  $v$* , we mean changing the sign of every edge incident to  $v$ .

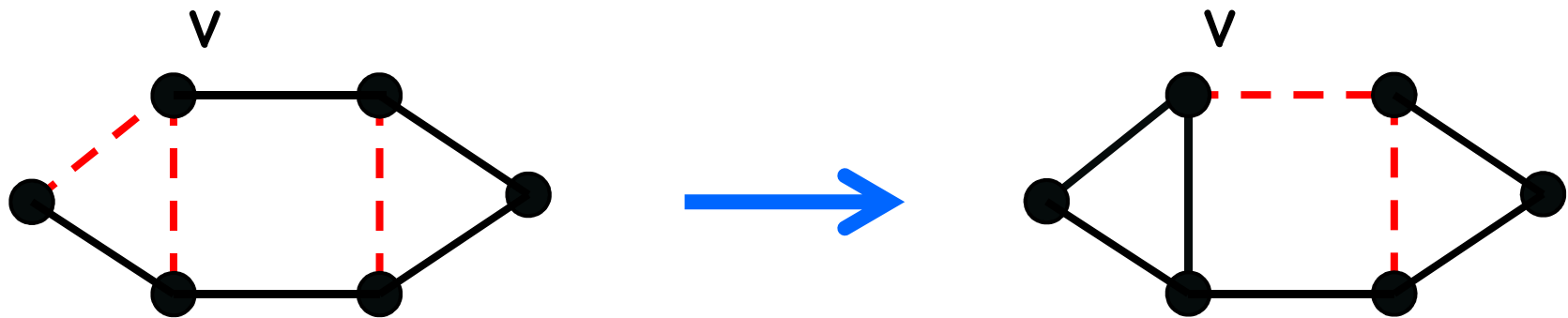

# Resigning

Resigning sequentially at vertices  $v_1, \dots, v_k$ , is equivalent to changing the signs of the *edge-cut*  $(S, E(G) \setminus S)$ , where  $S = \{v_1, \dots, v_k\}$ .

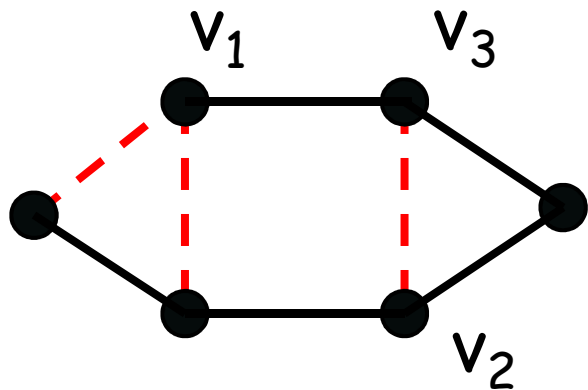



# Resigning

Resigning sequentially at vertices  $v_1, \dots, v_k$ , is equivalent to changing the signs of the *edge-cut*  $(S, E(G) \setminus S)$ , where  $S = \{v_1, \dots, v_k\}$ .

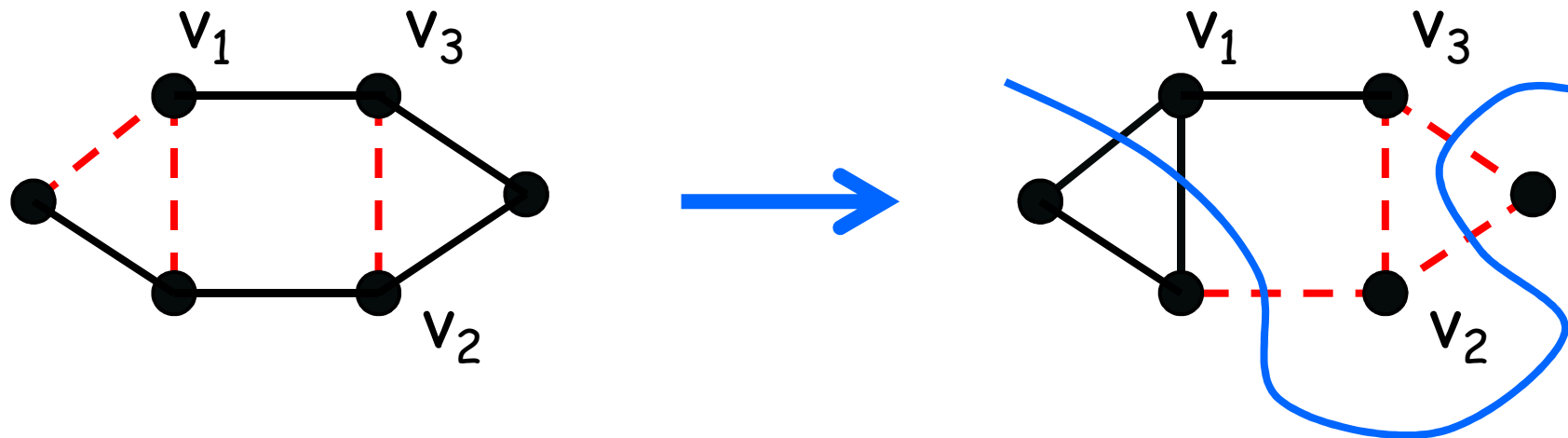

# Signed graphs

Two signified graphs  $(G, \Sigma)$  and  $(G', \Sigma')$  are **equivalent** if  $G = G'$  and  $(G', \Sigma')$  can be obtained from  $(G, \Sigma)$  by a sequence of resignings.

# Signed graphs

Two signified graphs  $(G, \Sigma)$  and  $(G', \Sigma')$  are **equivalent** if  $G = G'$  and  $(G', \Sigma')$  can be obtained from  $(G, \Sigma)$  by a sequence of resignings.

A **signed graph** is an *equivalence class* of signified graphs. A signed graph is denoted  $(G, \Sigma)$ , where  $(G, \Sigma)$  is any representative of this class.

# Signed graphs

Two signified graphs  $(G, \Sigma)$  and  $(G', \Sigma')$  are **equivalent** if  $G = G'$  and  $(G', \Sigma')$  can be obtained from  $(G, \Sigma)$  by a sequence of resignings.

A **signed graph** is an *equivalence class* of signified graphs. A signed graph is denoted  $(G, \Sigma)$ , where  $(G, \Sigma)$  is any representative of this class.

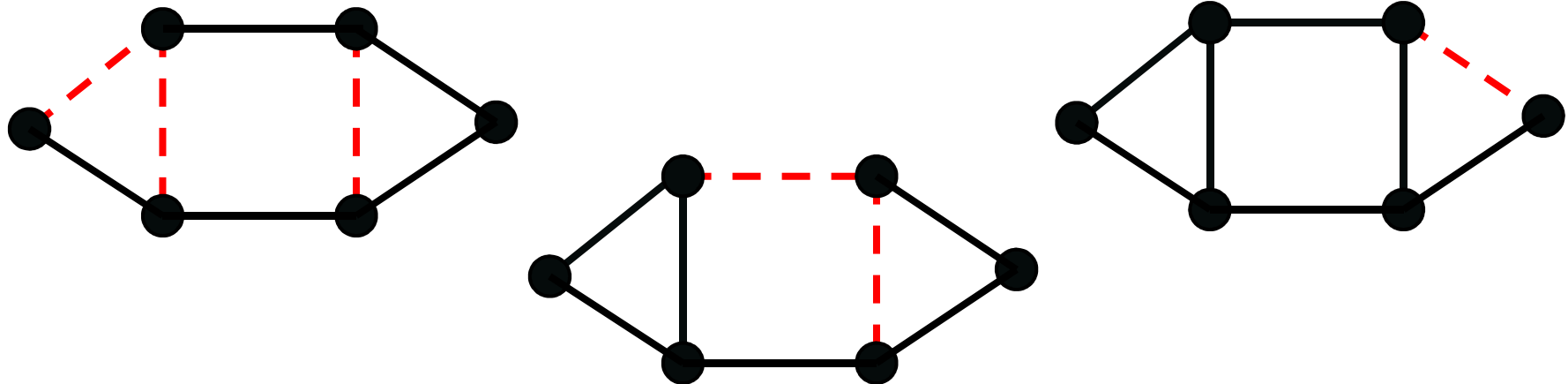

# Cycles in signed graphs

A cycle in  $(G, \Sigma)$  is either **balanced**, if it contains an *even* number of negative edges, or **unbalanced**, if it contains an *odd* number of negative edges.

# Cycles in signed graphs

A cycle in  $(G, \Sigma)$  is either **balanced**, if it contains an *even* number of negative edges, or **unbalanced**, if it contains an *odd* number of negative edges.

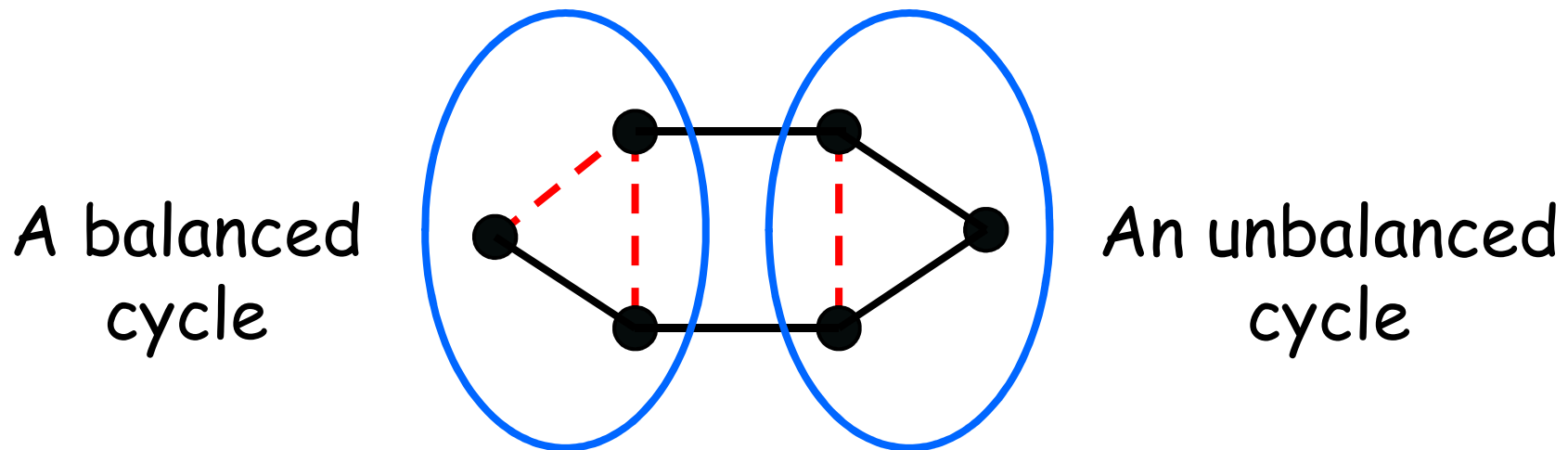

# Cycles in signed graphs

**Theorem (Zaslavsky, 1982).**

Two signified graphs are equivalent if and only if they have the same set of unbalanced cycles.



# Cycles in signed graphs

**Theorem (Zaslavsky, 1982).**

Two signified graphs are equivalent if and only if they have the same set of unbalanced cycles.

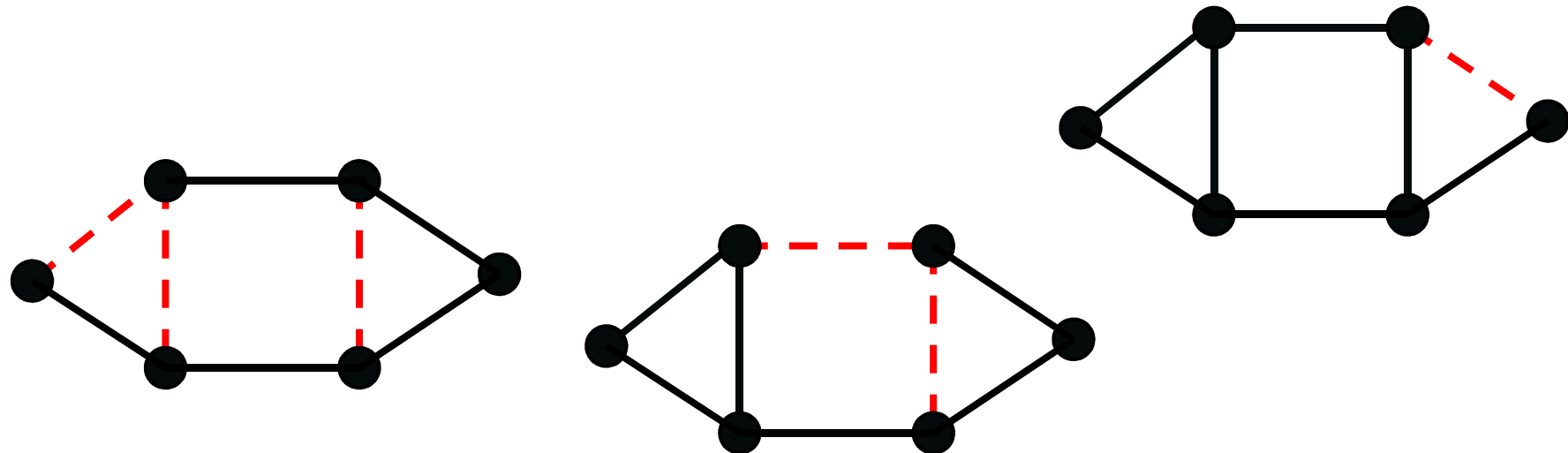



# Cycles in signed graphs

**Theorem (Zaslavsky, 1982).**

Two signified graphs are equivalent if and only if they have the same set of unbalanced cycles.

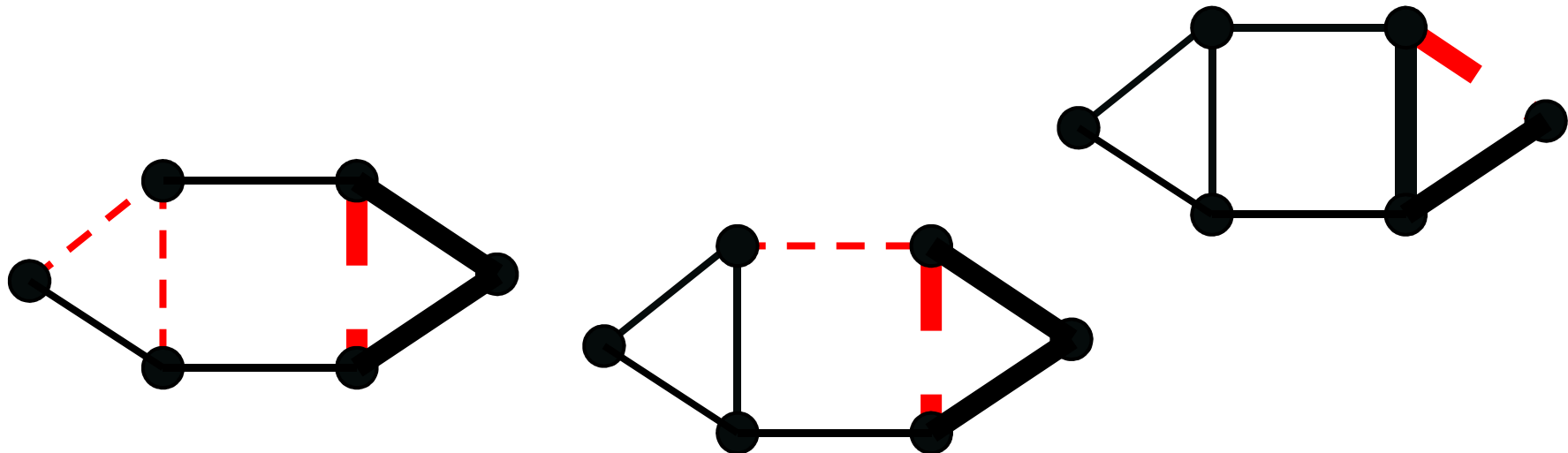

# Cycles in signed graphs

**Theorem (Zaslavsky, 1982).**

Two signified graphs are equivalent if and only if they have the same set of unbalanced cycles.

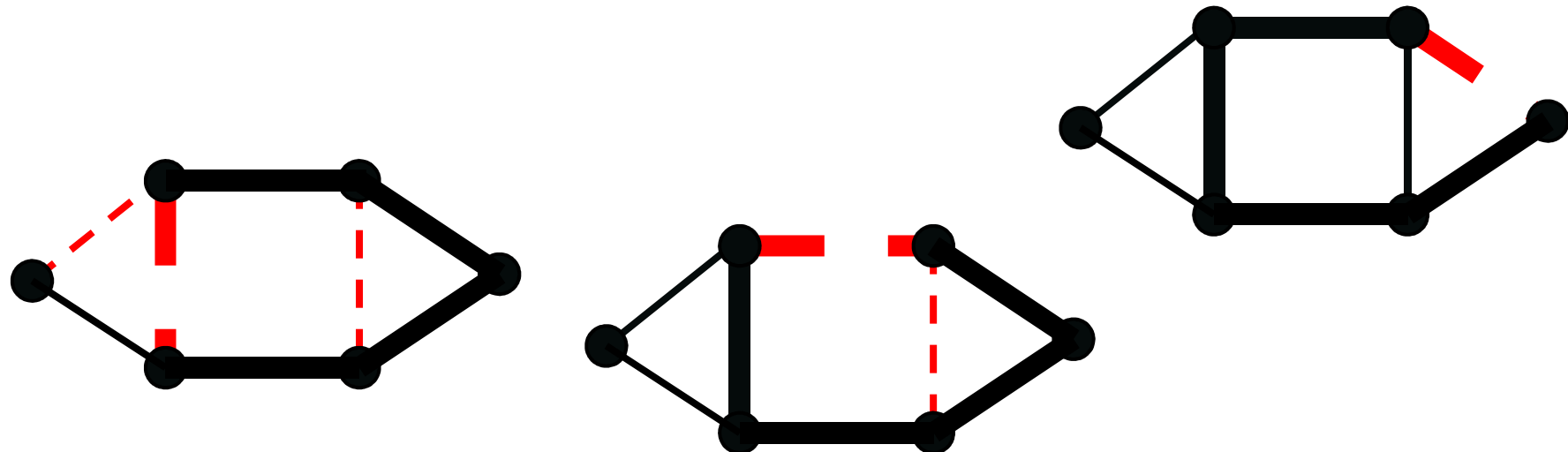

# Cycles in signed graphs

**Theorem (Zaslavsky, 1982).**

Two signified graphs are equivalent if and only if they have the same set of unbalanced cycles.

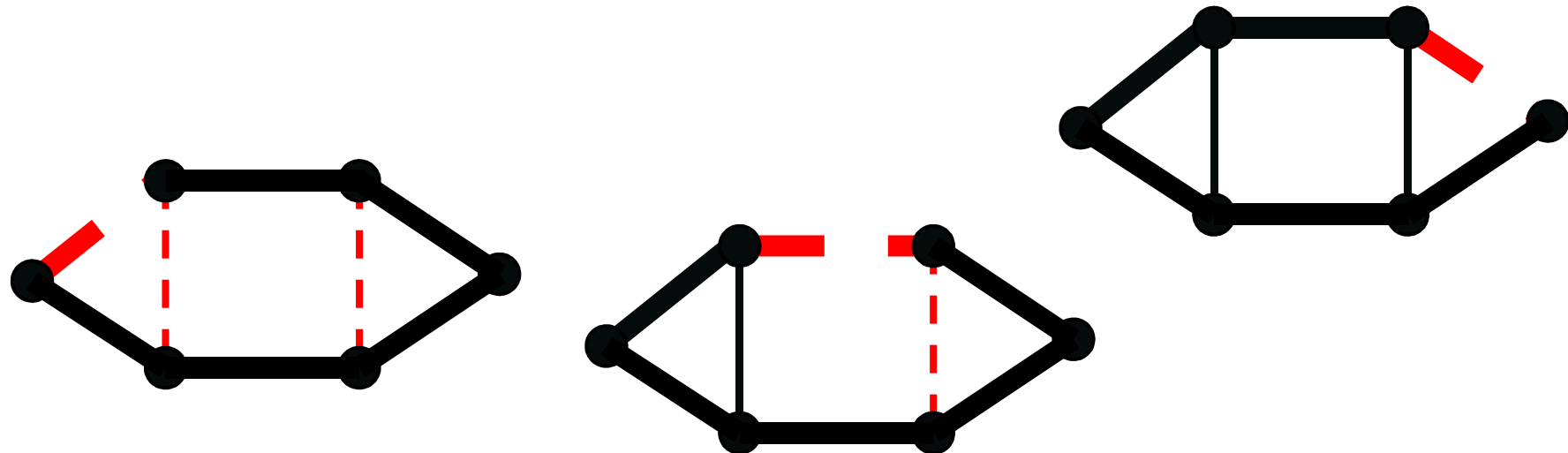

# Cycles in signed graphs

**Theorem (Zaslavsky, 1982).**

Two signified graphs are equivalent if and only if they have the same set of unbalanced cycles.

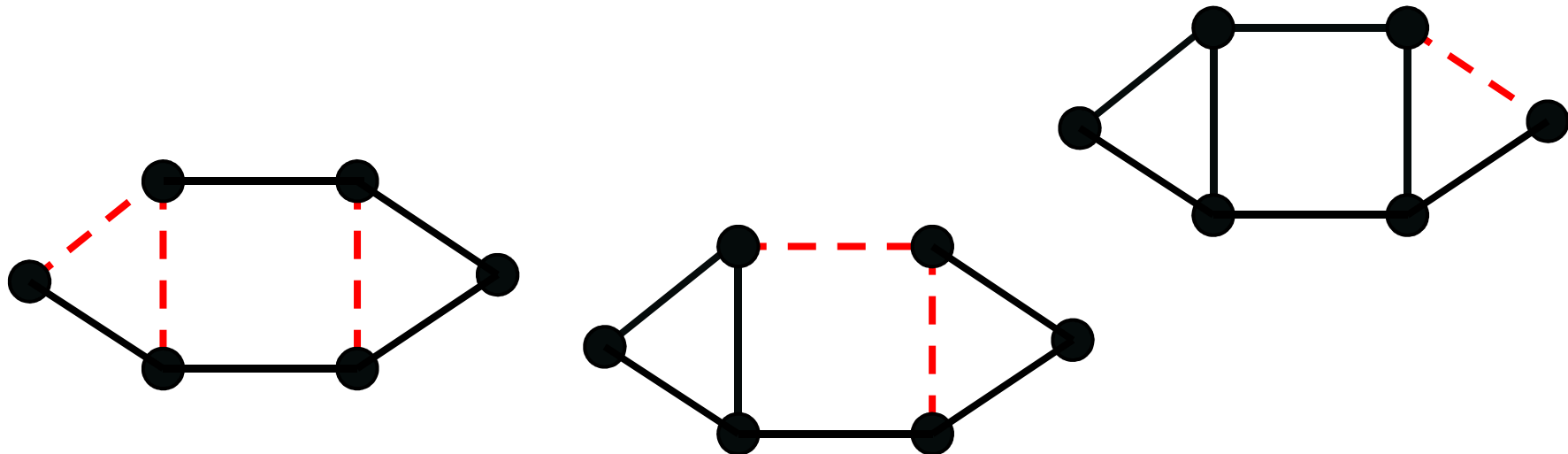

# Homomorphisms of signed graphs

A **homomorphism** of  $(G, \Sigma)$  to  $(H, T)$  is a *sign-preserving* homomorphism from  $(G, \Sigma')$  to  $(H, T)$ , where  $(G, \Sigma')$  and  $(G, \Sigma)$  are equivalent.

# Homomorphisms of signed graphs

A **homomorphism** of  $(G, \Sigma)$  to  $(H, T)$  is a *sign-preserving* homomorphism from  $(G, \Sigma')$  to  $(H, T)$ , where  $(G, \Sigma')$  and  $(G, \Sigma)$  are equivalent.

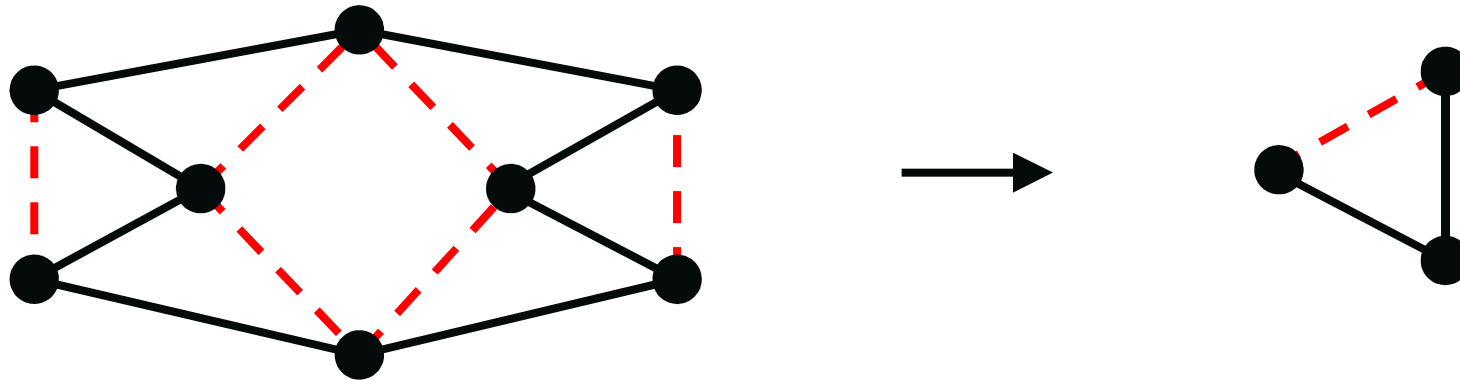

# Homomorphisms of signed graphs

A **homomorphism** of  $(G, \Sigma)$  to  $(H, T)$  is a *sign-preserving* homomorphism from  $(G, \Sigma')$  to  $(H, T)$ , where  $(G, \Sigma')$  and  $(G, \Sigma)$  are equivalent.

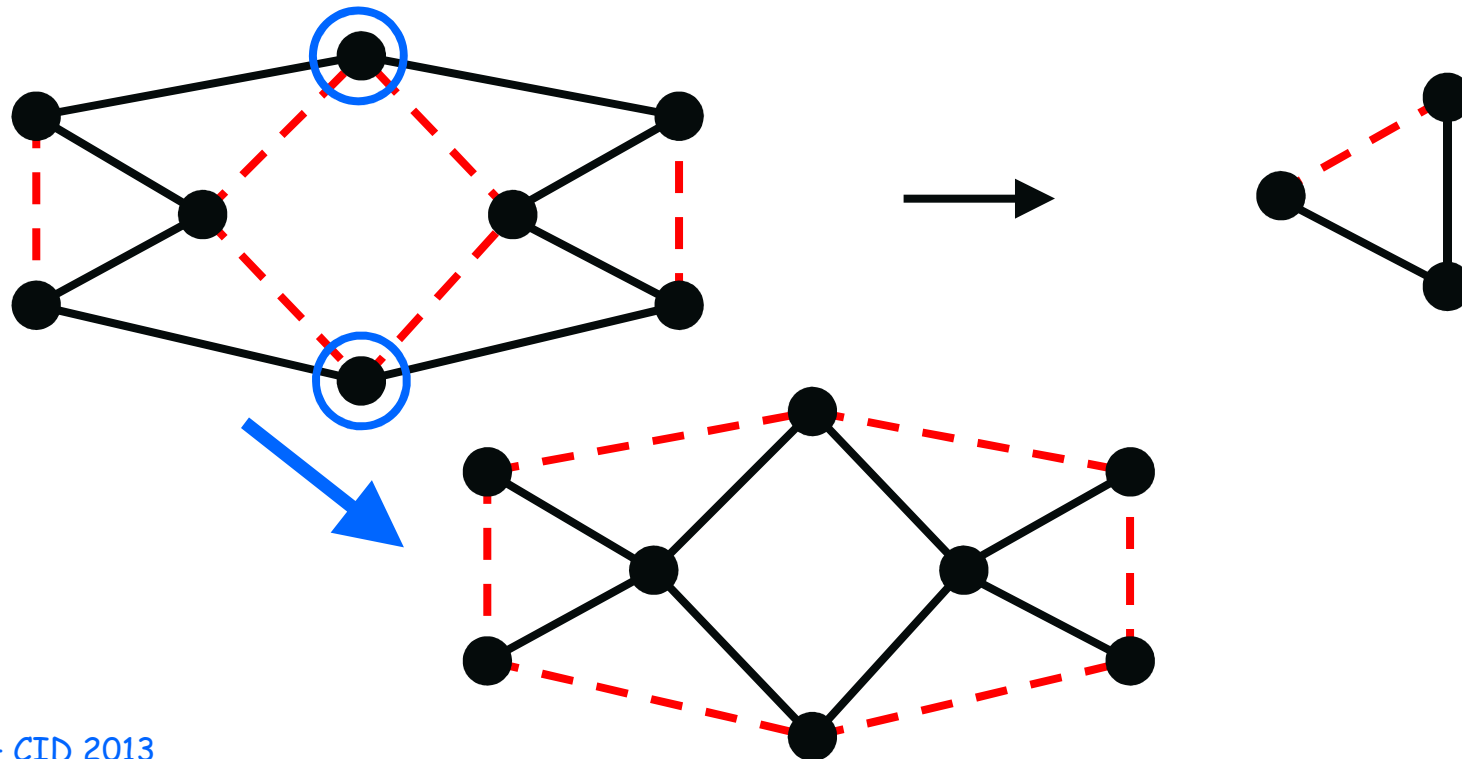

# Homomorphisms of signed graphs

A **homomorphism** of  $(G, \Sigma)$  to  $(H, T)$  is a *sign-preserving* homomorphism from  $(G, \Sigma')$  to  $(H, T)$ , where  $(G, \Sigma')$  and  $(G, \Sigma)$  are equivalent.

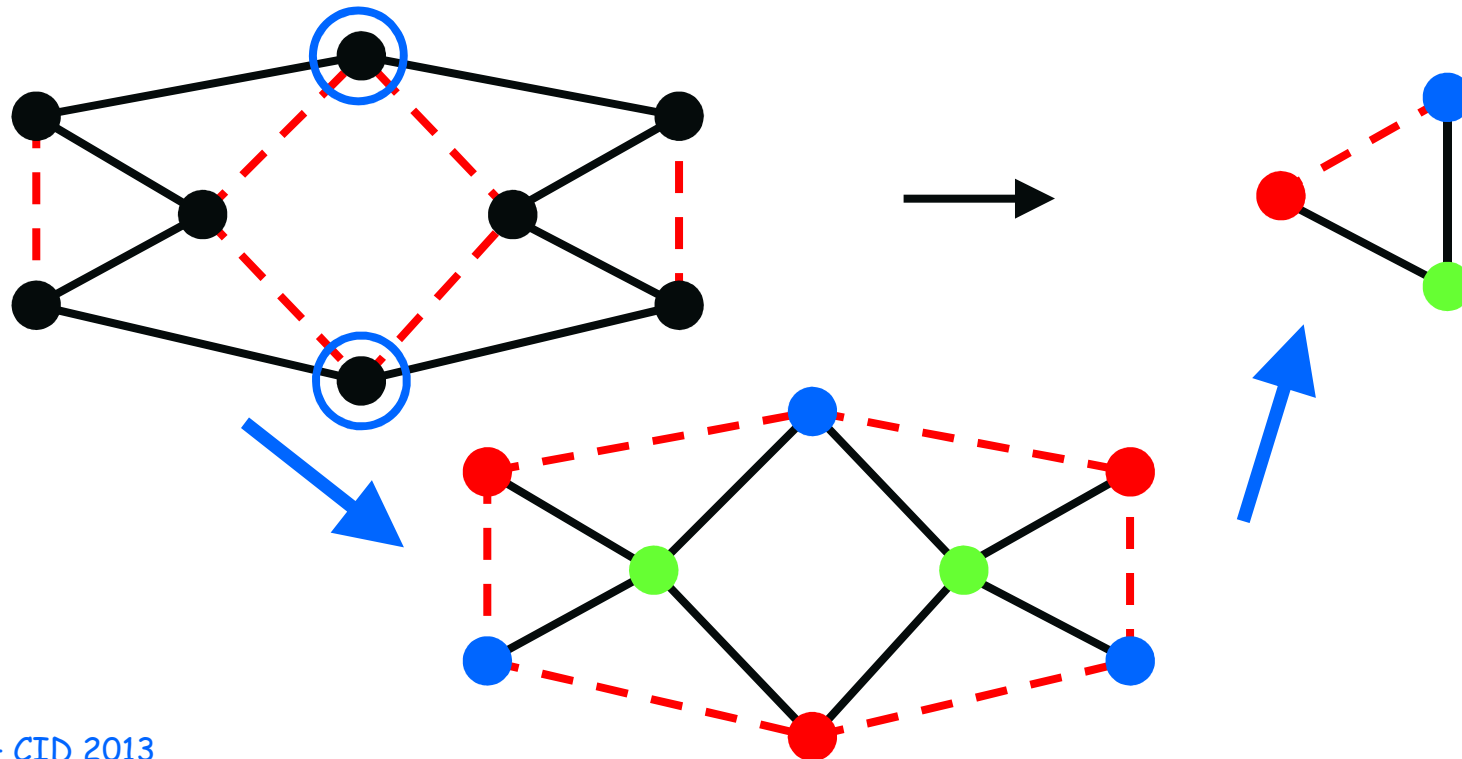



# Minors of signed graphs

A signed graph  $(H, T)$  is a **minor** of  $(G, \Sigma)$  if  $(H, T)$  can be obtained from  $(G, \Sigma)$  by

- *resigning*,
- deleting vertices,
- deleting edges, and
- contracting *positive* edges, *not belonging to an unbalanced 3-cycle*.

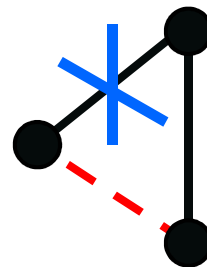

# Minors of signed graphs

A signed graph  $(H, T)$  is a **minor** of  $(G, \Sigma)$  if  $(H, T)$  can be obtained from  $(G, \Sigma)$  by

- *resigning*,
- deleting vertices,
- deleting edges, and
- contracting *positive* edges, *not belonging to an unbalanced 3-cycle*.

*Note that none of these operations can create an unbalanced cycle, in contrast to graph minor operations that may produce odd cycles...*

# Minors of signed graphs

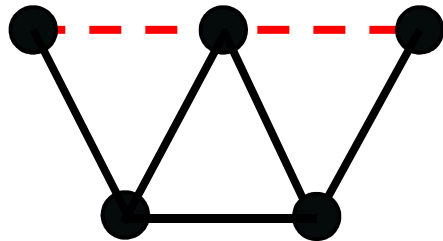

is a minor of

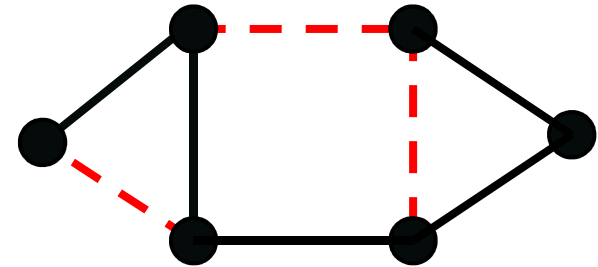

# Minors of signed graphs

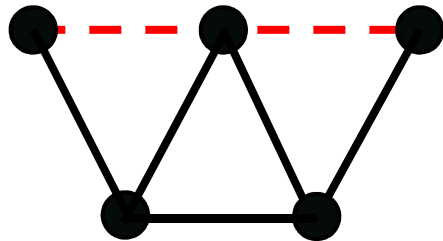

is a minor of

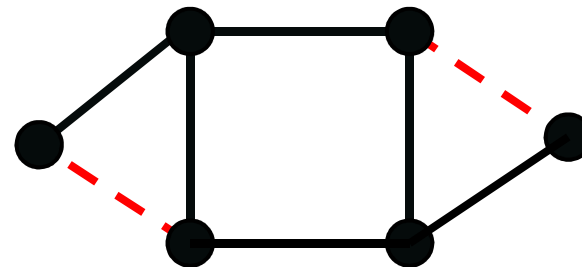
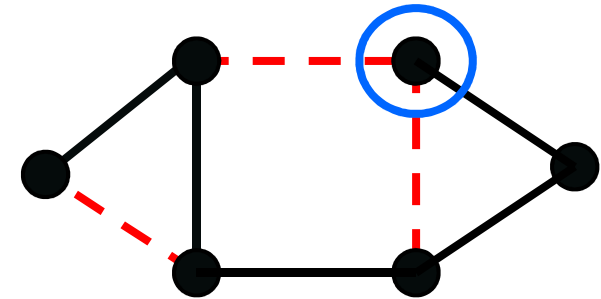

# Minors of signed graphs

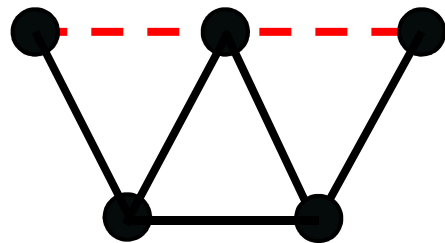

is a minor of

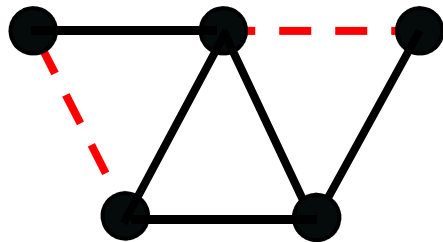
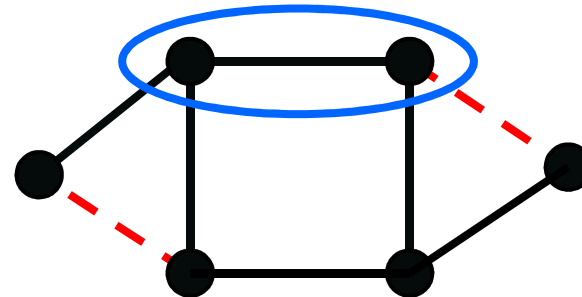
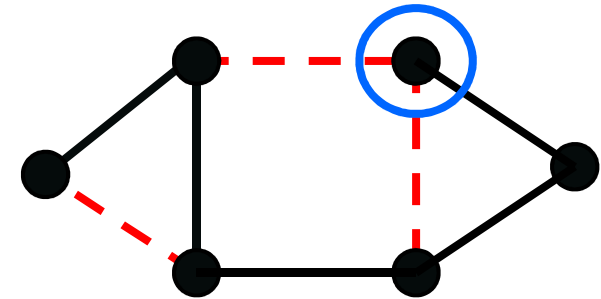

# Minors of signed graphs

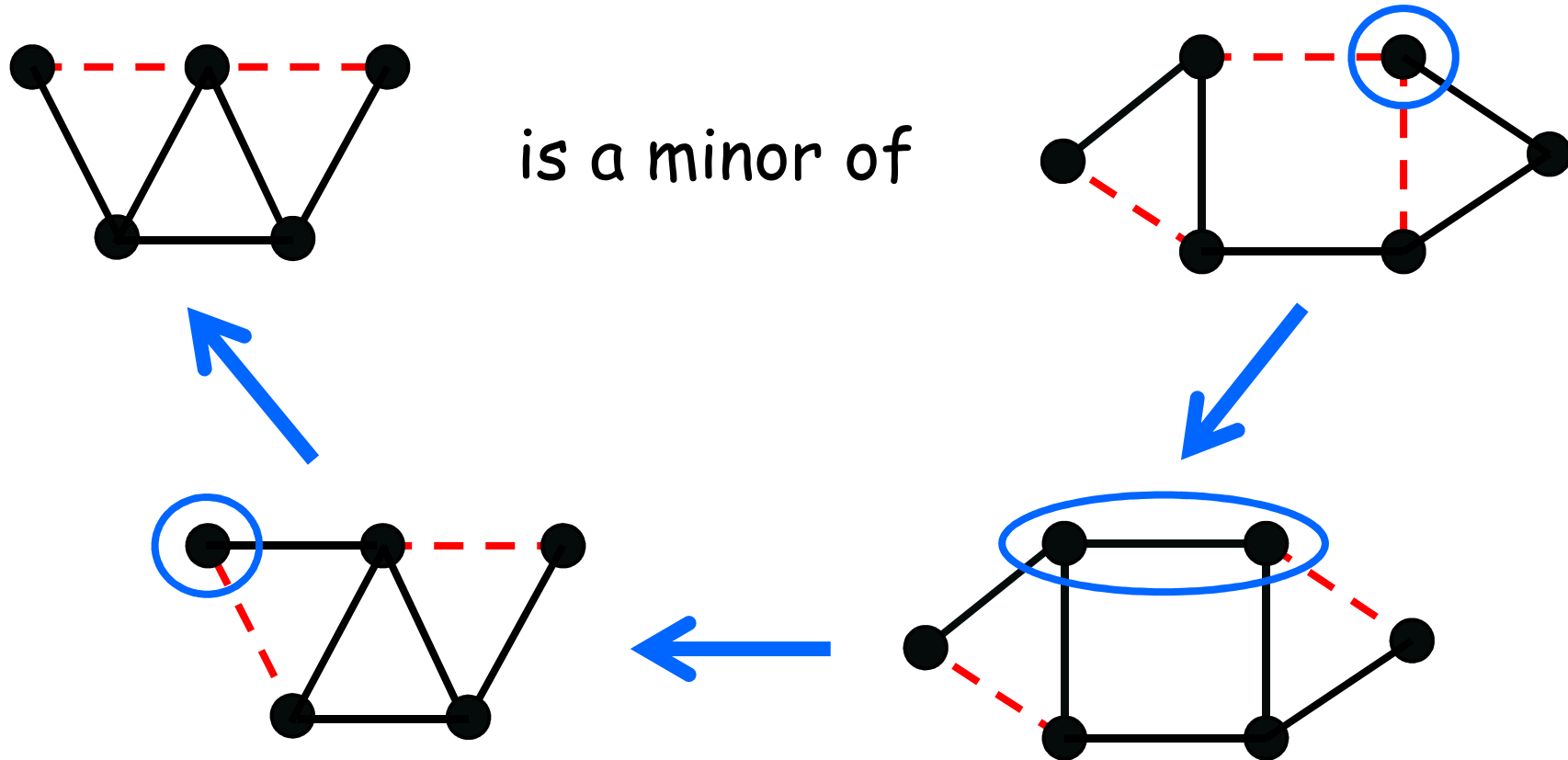

# Consistent signed graphs

A signed graph is **consistent** if

- the length of every *balanced* cycle is *even*,
- the lengths of all *unbalanced* cycles have the *same parity*.

# Consistent signed graphs

A signed graph is **consistent** if

- the length of every *balanced* cycle is *even*,
- the lengths of all *unbalanced* cycles have the *same parity*.

We thus have two classes of consistent signed graphs:

- **odd signed graphs:** all unbalanced cycles are of *odd length*,
- **signed bipartite graphs:** all unbalanced cycles are of *even length*.



# Consistent signed graphs

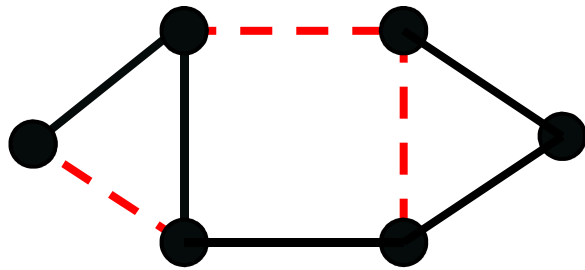

An odd signed graph  
balanced  $\rightarrow$  even length  
unbalanced  $\rightarrow$  odd length

# Consistent signed graphs

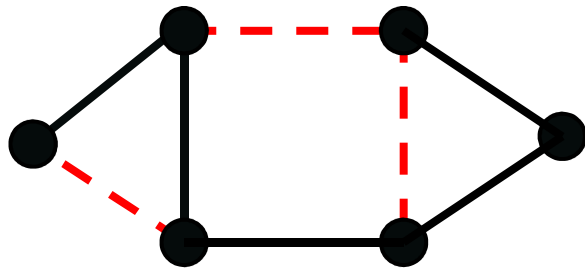

An odd signed graph  
balanced  $\rightarrow$  even length  
unbalanced  $\rightarrow$  odd length

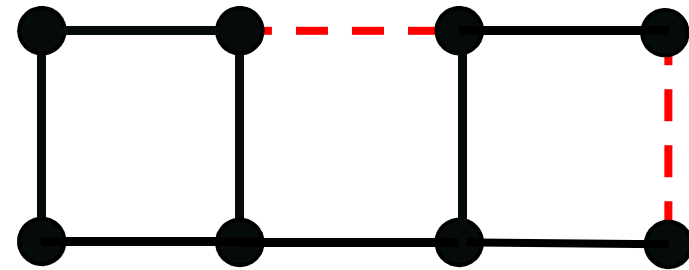

A signed bipartite graph  
balanced  $\rightarrow$  even length  
unbalanced  $\rightarrow$  even length

# Consistent signed graphs

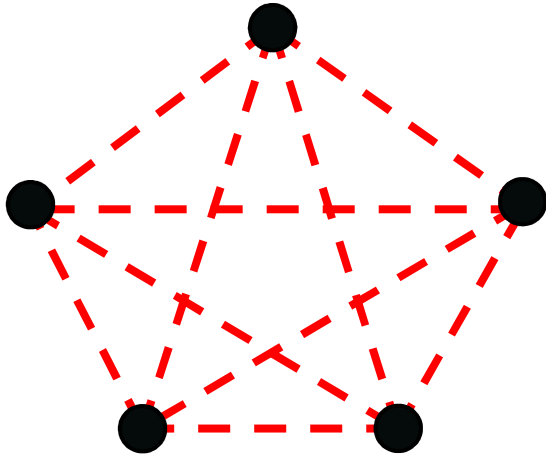

The **odd  $K_5$**   
balanced  $\rightarrow$  even length  
unbalanced  $\rightarrow$  odd length

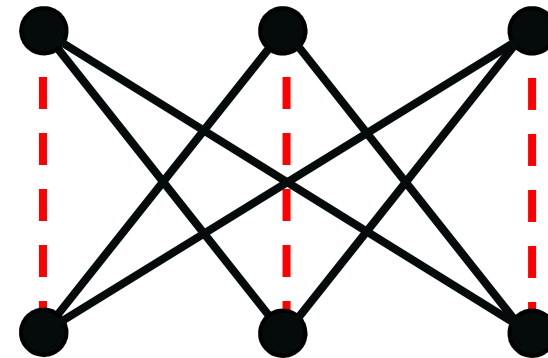

The signed bipartite  
graph  **$(K_{3,3}, M)$**   
balanced  $\rightarrow$  even length  
unbalanced  $\rightarrow$  even length

Odd signed graphs

# Odd signed graphs

balanced  $\rightarrow$  even length, unbalanced  $\rightarrow$  odd length

**Theorem (Zaslavsky, 1982).**

Two signified graphs are equivalent if and only if they have the same set of unbalanced cycles.

# Odd signed graphs

balanced  $\rightarrow$  even length, unbalanced  $\rightarrow$  odd length

**Theorem (Zaslavsky, 1982).**

Two signified graphs are equivalent if and only if they have the same set of unbalanced cycles.

Every odd signed graph  $(G, \Sigma)$  can be represented by  $(G, E(G))$ .

# Odd signed graphs

balanced  $\rightarrow$  even length, unbalanced  $\rightarrow$  odd length

**Theorem (Zaslavsky, 1982).**

Two signified graphs are equivalent if and only if they have the same set of unbalanced cycles.

Every odd signed graph  $(G, \Sigma)$  can be represented by  $(G, E(G))$ . Thus, for  $(G_1, \Sigma_1), (G_2, \Sigma_2)$  two odd signed graphs,

$(G_1, \Sigma_1) \rightarrow (G_2, \Sigma_2)$  if and only if  $G_1 \rightarrow G_2$ .

# Odd signed graphs

balanced  $\rightarrow$  even length, unbalanced  $\rightarrow$  odd length

**Theorem (Zaslavsky, 1982).**

Two signified graphs are equivalent if and only if they have the same set of unbalanced cycles.

Every odd signed graph  $(G, \Sigma)$  can be represented by  $(G, E(G))$ . Thus, for  $(G_1, \Sigma_1), (G_2, \Sigma_2)$  two odd signed graphs,

$(G_1, \Sigma_1) \rightarrow (G_2, \Sigma_2)$  if and only if  $G_1 \rightarrow G_2$ .

*Homomorphism questions can be translated in terms of homomorphisms of odd signed graphs...*



# Odd Hadwiger's conjecture

**Odd Hadwiger's Conjecture (Gerards & Seymour).**

If  $(G, E(G))$  has no  $(K_n, E(K_n))$  as a minor, then  $G$  is  $(n-1)$ -colourable.



# Odd Hadwiger's conjecture

**Odd Hadwiger's Conjecture (Gerards & Seymour).**

If  $(G, E(G))$  has no  $(K_n, E(K_n))$  as a minor, then  $G$  is  $(n-1)$ -colourable.

**Case  $n = 3$ .**

- Hadwiger's Conjecture says that every *forest* is 2-colourable ( $K_3$ -minor free).

# Odd Hadwiger's conjecture

**Odd Hadwiger's Conjecture (Gerards & Seymour).**  
If  $(G, E(G))$  has no  $(K_n, E(K_n))$  as a minor, then  $G$  is  $(n-1)$ -colourable.

**Case  $n = 3$ .**

- Hadwiger's Conjecture says that every *forest* is 2-colourable ( $K_3$ -minor free).
- Odd Hadwiger's Conjecture says that every *bipartite graph* is 2-colourable.

# Odd Hadwiger's conjecture

**Odd Hadwiger's Conjecture (Gerards & Seymour).**

If  $(G, E(G))$  has no  $(K_n, E(K_n))$  as a minor, then  $G$  is  $(n-1)$ -colourable.

- $n = 4$ : proved by Catlin (1979),
- $n = 5$ : announced by Guenin (2005, unpublished), would imply the Four-Colour Theorem.

# Signed bipartite graphs

# Signed bipartite graphs

balanced  $\rightarrow$  even length, unbalanced  $\rightarrow$  even length

# Signed bipartite graphs

balanced  $\rightarrow$  even length, unbalanced  $\rightarrow$  even length

With every graph  $G$ , one can associate a signed bipartite graph  $S(G)$  by replacing each edge of  $G$  by an *unbalanced 4-cycle*.

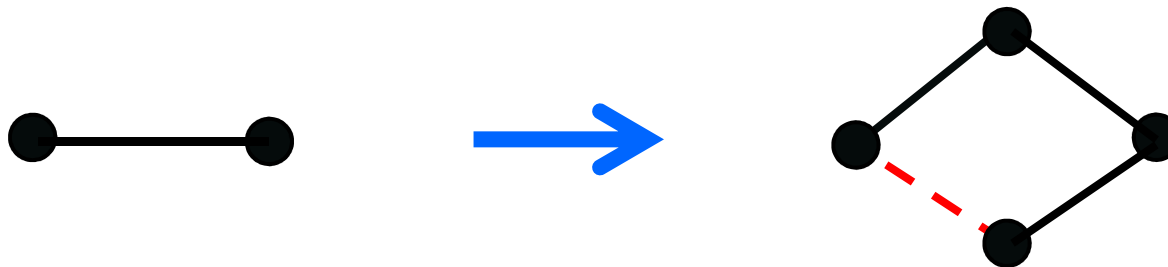

# Signed bipartite graphs

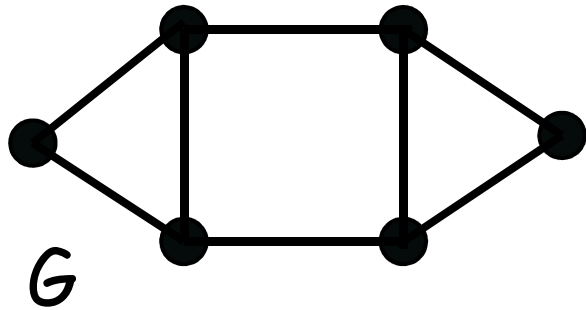



# Signed bipartite graphs

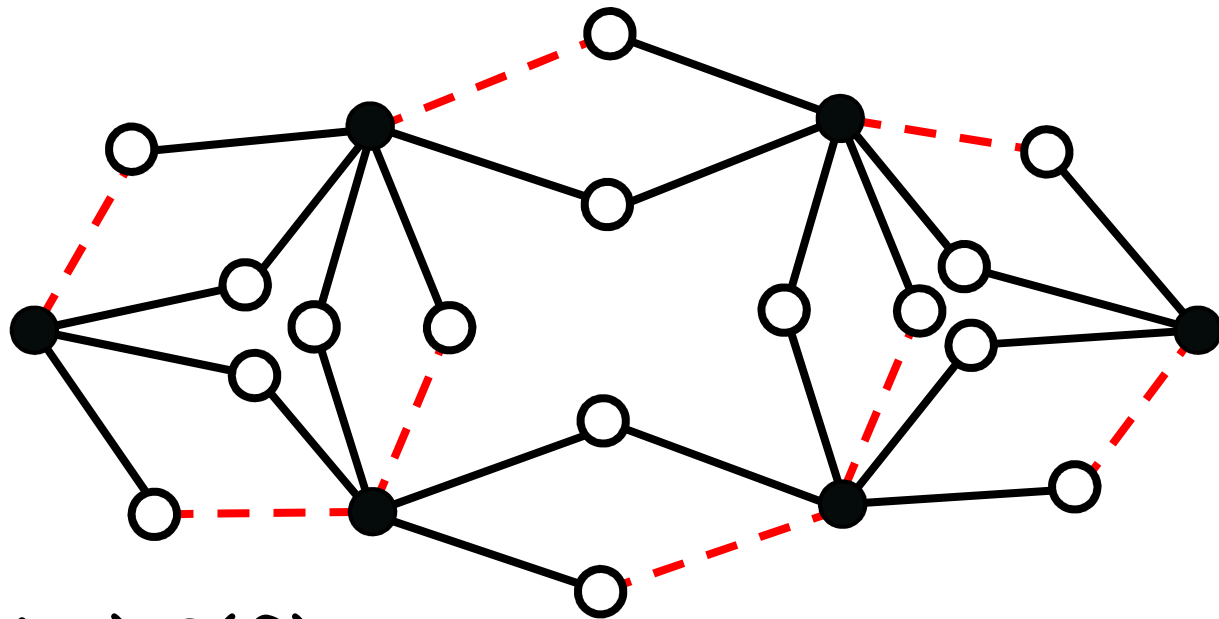
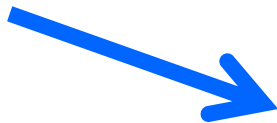
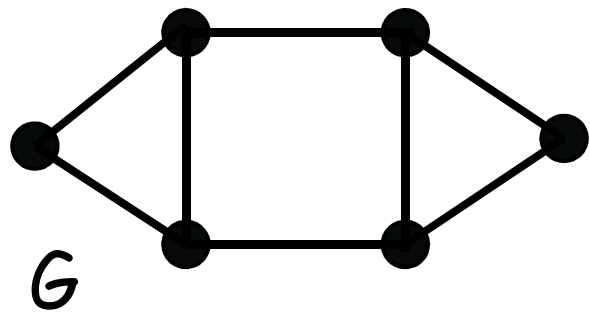

(bipartite)  $S(G)$

# Signed bipartite graphs

**Theorem (Naserasr, Rollová, ES, 2012+).**

For every graph  $G$ , and every  $k \geq 3$ ,

$\chi(G) \leq k$  if and only if  $S(G) \rightarrow (K_{k,k}, M)$

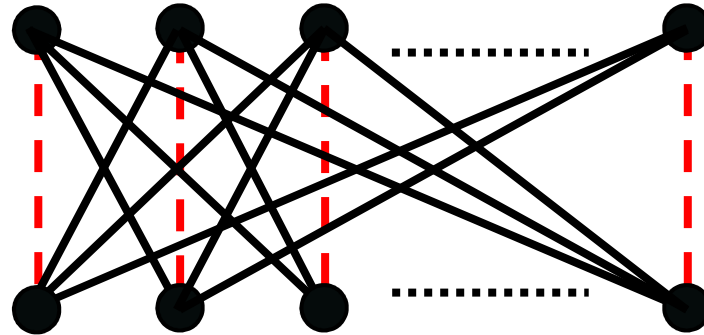

# Signed bipartite graphs

**Theorem (Naserasr, Rollová, ES, 2012+).**

For every graph  $G$ , and every  $k \geq 3$ ,

$\chi(G) \leq k$  if and only if  $S(G) \rightarrow (K_{k,k}, M)$

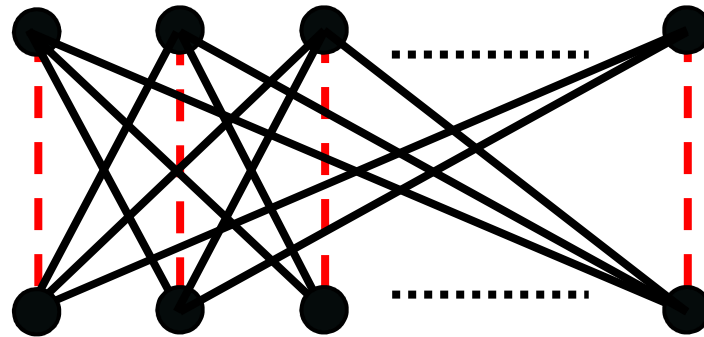

*Questions about chromatic number can be translated in terms of homomorphisms of signed bipartite graphs...*

# Signed bipartite graphs

**Theorem (Naserasr, Rollová, ES, 2012+).**

For every graphs  $G$  and  $H$ ,

$G \rightarrow H$  if and only if  $S(G) \rightarrow S(H)$

# Signed bipartite graphs

**Theorem (Naserasr, Rollová, ES, 2012+).**

For every graphs  $G$  and  $H$ ,

$G \rightarrow H$  if and only if  $S(G) \rightarrow S(H)$

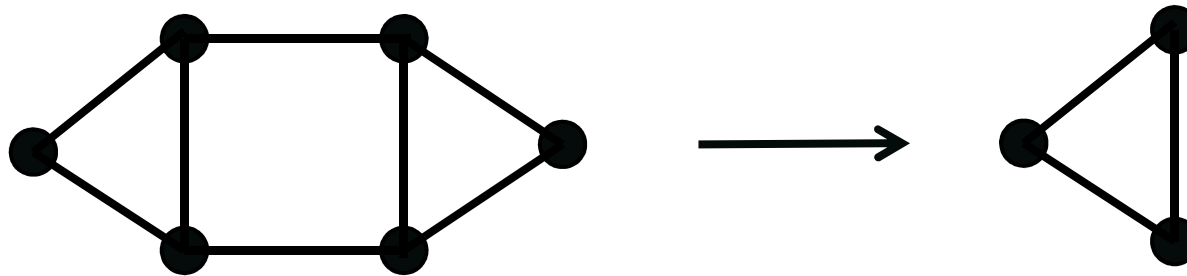

# Signed bipartite graphs

**Theorem (Naserasr, Rollová, ES, 2012+).**

For every graphs  $G$  and  $H$ ,

$G \rightarrow H$  if and only if  $S(G) \rightarrow S(H)$

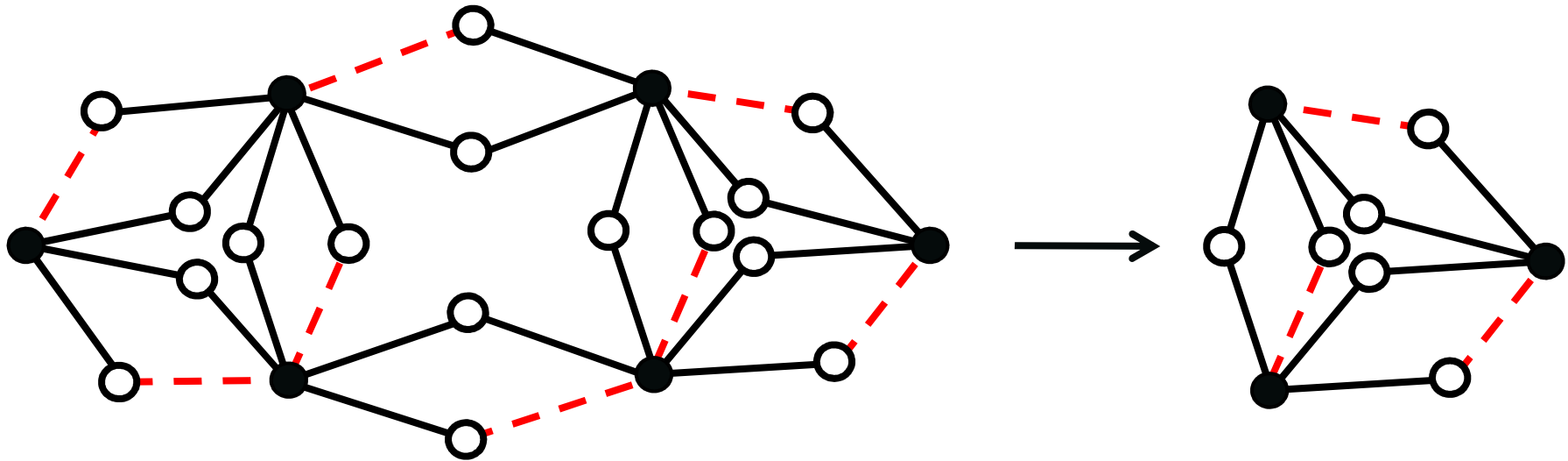

# Signed bipartite graphs

**Theorem (Naserasr, Rollová, ES, 2012+).**

For every graphs  $G$  and  $H$ ,

$G \rightarrow H$  if and only if  $S(G) \rightarrow S(H)$

*Homomorphism questions can be translated in terms of homomorphisms of signed bipartite graphs...*

# Signed bipartite graphs

**Theorem (Naserasr, Rollová, ES, 2012+).**

For every integer  $n$  and every graph  $G$ ,  $K_n$  is a minor of  $G$  if and only if  $(K_n, \Sigma)$  is a minor of  $S(G)$  for some (any)  $\Sigma$ .



# Signed bipartite graphs

**Theorem (Naserasr, Rollová, ES, 2012+).**

For every integer  $n$  and every graph  $G$ ,  $K_n$  is a minor of  $G$  if and only if  $(K_n, \Sigma)$  is a minor of  $S(G)$  for some (any)  $\Sigma$ .

*Hadwiger's Conjecture can thus be restated as:*

**Hadwiger's Conjecture (1943).**

If a graph  $G$  has no  $K_n$  as a minor, then

$$S(G) \rightarrow (K_{n-1, n-1}, M)$$

# Signed bipartite graphs

**Hadwiger's Conjecture (1943).**

If a graph  $G$  has no  $K_n$  as a minor, then

$$S(G) \rightarrow (K_{n-1,n-1}, M)$$

# Signed bipartite graphs

**Hadwiger's Conjecture (1943).**

If a graph  $G$  has no  $K_n$  as a minor, then

$$S(G) \rightarrow (K_{n-1,n-1}, M)$$

For  $n = 4$ , we prove the following generalization:

**Theorem (Naserasr, Rollová, ES, 2012+).**

If  $G$  is bipartite and has no  $K_4$ -minor then, for every signature  $\Sigma$  on  $G$ ,  $(G, \Sigma) \rightarrow (K_{3,3}, M)$ .

# Signed bipartite graphs

**Theorem (Naserasr, Rollová, ES, 2012+).**

If  $G$  is bipartite and has no  $K_4$ -minor then, for every signature  $\Sigma$  on  $G$ ,  $(G, \Sigma) \rightarrow (K_{3,3}, M)$ .

# Signed bipartite graphs

**Theorem (Naserasr, Rollová, ES, 2012+).**

If  $G$  is bipartite and has no  $K_4$ -minor then, for every signature  $\Sigma$  on  $G$ ,  $(G, \Sigma) \rightarrow (K_{3,3}, M)$ .

We propose the following stronger statement:

**Conjecture.** If  $G$  is bipartite and  $(G, \Sigma)$  has no  $(K_4, E(K_4))$  as a minor, then  $(G, \Sigma) \rightarrow (K_{3,3}, M)$ .

# Signed bipartite graphs

**Conjecture.** If  $G$  is bipartite and  $(G, \Sigma)$  has no  $(K_4, E(K_4))$  as a minor, then  $(G, \Sigma) \rightarrow (K_{3,3}, M)$ .

# Signed bipartite graphs

**Conjecture.** If  $G$  is bipartite and  $(G, \Sigma)$  has no  $(K_4, E(K_4))$  as a minor, then  $(G, \Sigma) \rightarrow (K_{3,3}, M)$ .

Guenin proposed the following:

**Conjecture (Guenin, 2005).**

If  $G$  is bipartite and  $(G, \Sigma)$  has no  $(K_5, E(K_5))$  as a minor, then  $(G, \Sigma) \rightarrow (K_{4,4}, M)$ .



# Signed bipartite graphs

**Conjecture.** If  $G$  is bipartite and  $(G, \Sigma)$  has no  $(K_4, E(K_4))$  as a minor, then  $(G, \Sigma) \rightarrow (K_{3,3}, M)$ .

Guenin proposed the following:

**Conjecture (Guenin, 2005).**

If  $G$  is bipartite and  $(G, \Sigma)$  has no  $(K_5, E(K_5))$  as a minor, then  $(G, \Sigma) \rightarrow (K_{4,4}, M)$ .



*We know that such a conjecture does not hold for  $n \geq 7$ ...*



# The signed graph $F = (K_{7,7}, \Phi)$

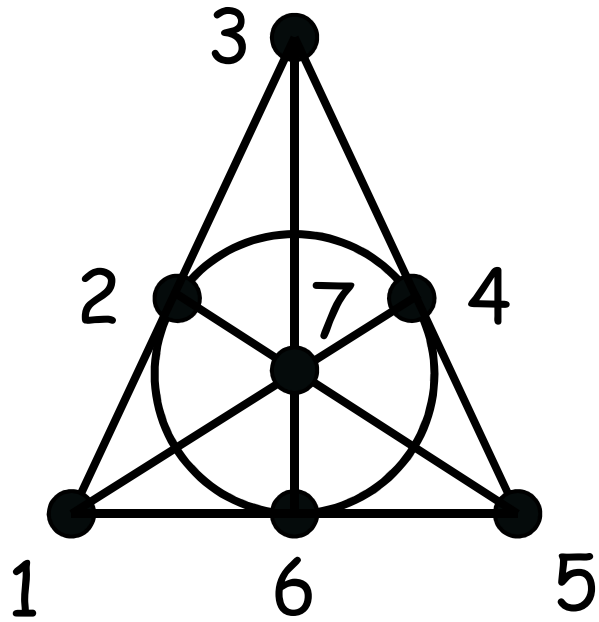

The Fano plane

# The signed graph $F = (K_{7,7}, \Phi)$

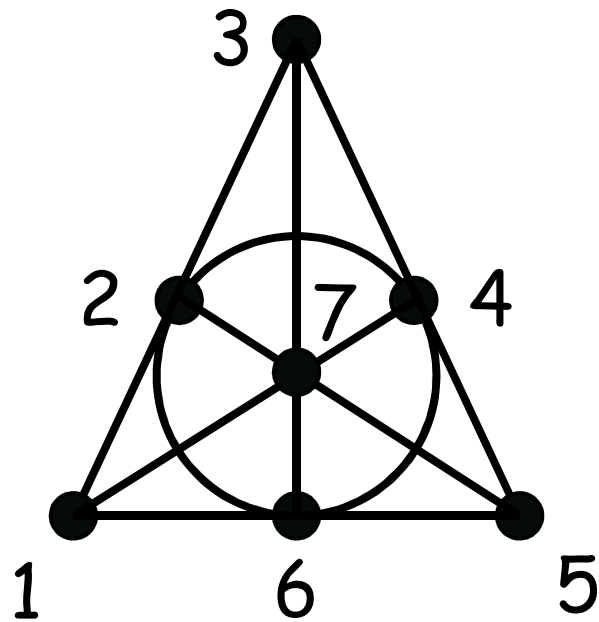

The Fano plane

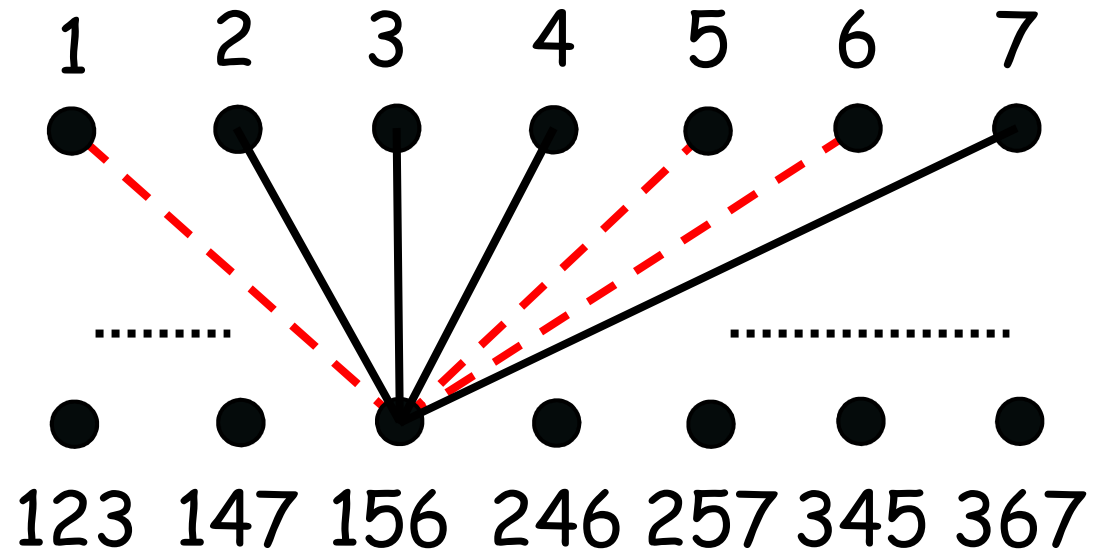

The signed graph  $F = (K_{7,7}, \Phi)$   
 $(i, \{a,b,c\}) \in \Phi$  iff  $i \in \{a,b,c\}$

# The signed graph $F = (K_{7,7}, \Phi)$

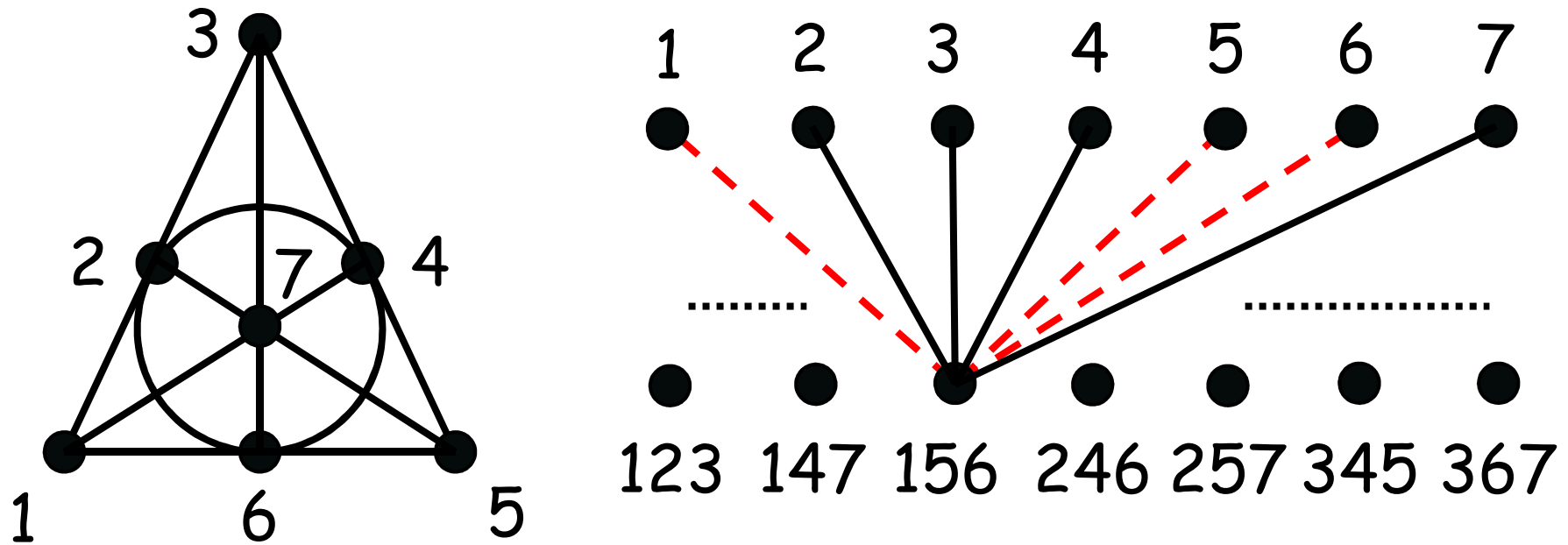

**Theorem (Naserasr, Rollová, ES, 2012+).**  
 There is no value  $n$  for which  $F \rightarrow (K_{n,n}, M)$ .

# Homomorphisms to signed projective cubes

# Projective cubes

The **cube** of *dimension*  $d$  is the Cayley graph  $\mathcal{C}_d = ((\mathbb{Z}_2)^d, \{e_1, e_2, \dots, e_d\})$ , where  $e_i = (0, \dots, 0, 1, 0, \dots, 0)$

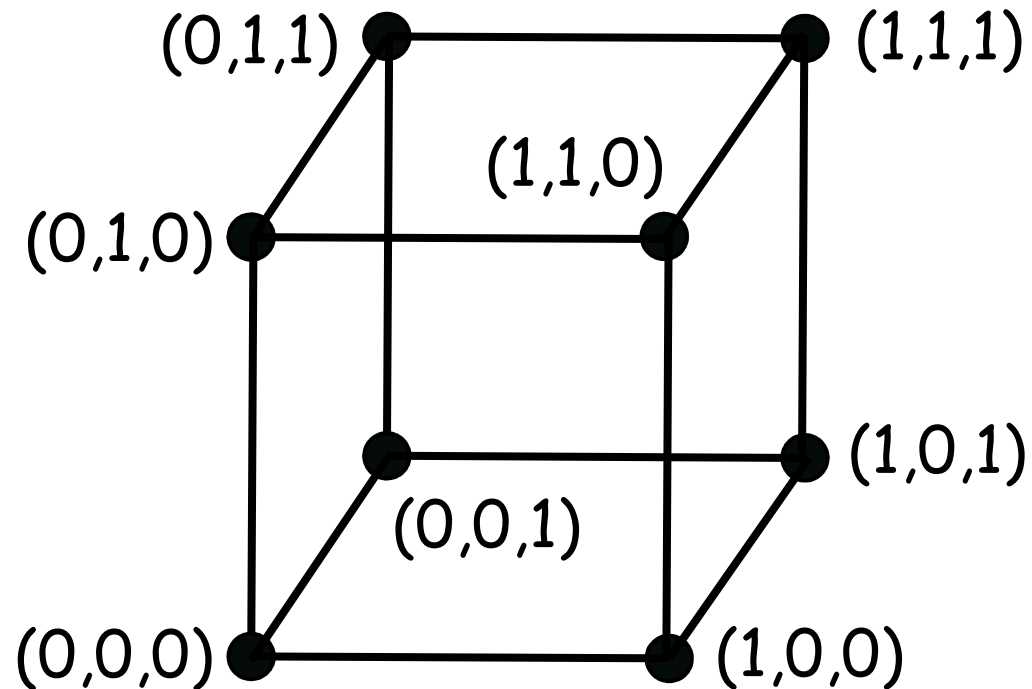
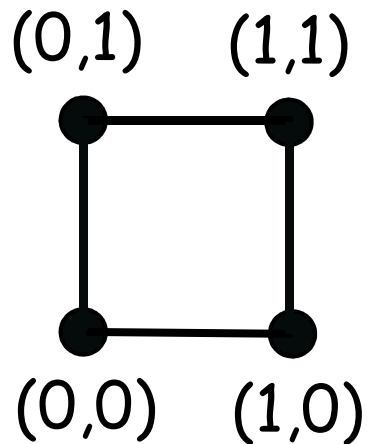

# Projective cubes

The **projective cube** of *dimension*  $d$  is the Cayley graph  $PC_d = ( (\mathbb{Z}_2)^d, \{ e_1, e_2, \dots, e_d, j \} )$ , where  $e_i = (0, \dots, 0, 1, 0, \dots, 0)$  and  $j = (1, 1, \dots, 1)$ .

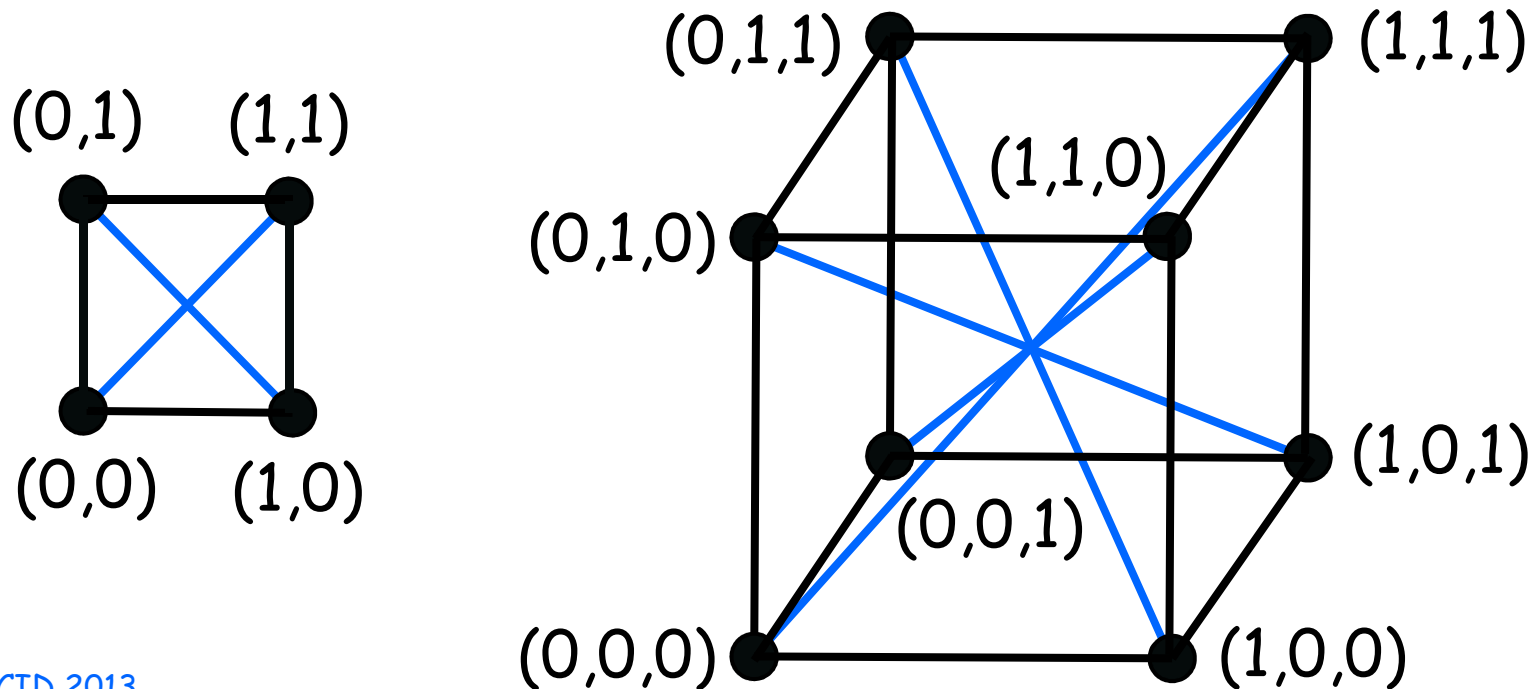

# Signed projective cubes

The **signed projective cube** of *dimension  $d$*  is defined by  $\mathbf{SPC}_d = (\mathbf{PC}_d, \mathbf{J})$ .

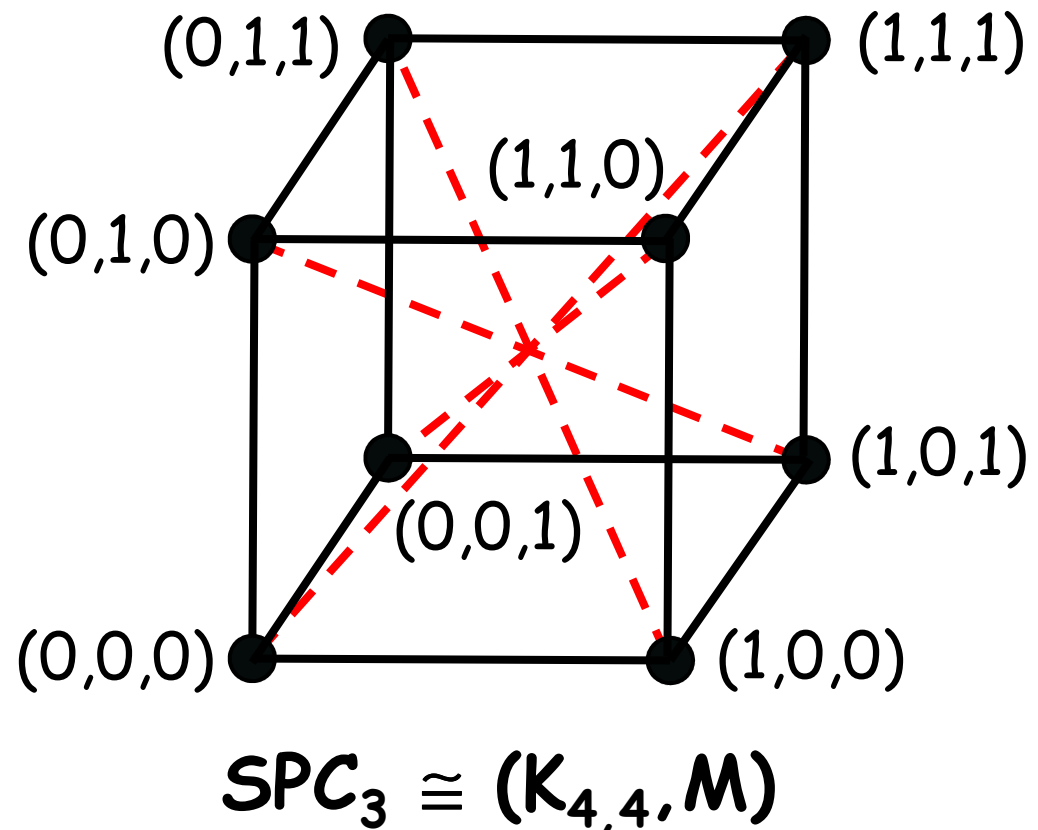
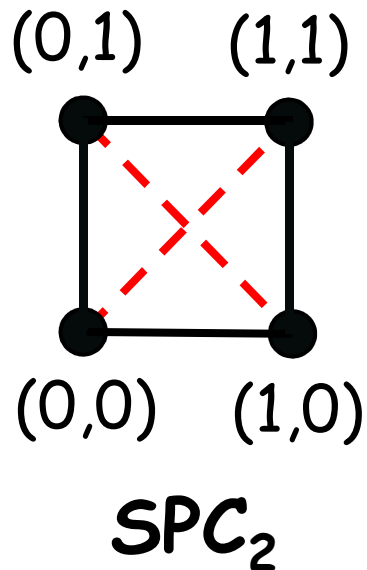

# Signed projective cubes

If  $d$  is even,  $SPC_d$  is an *odd signed graph*.

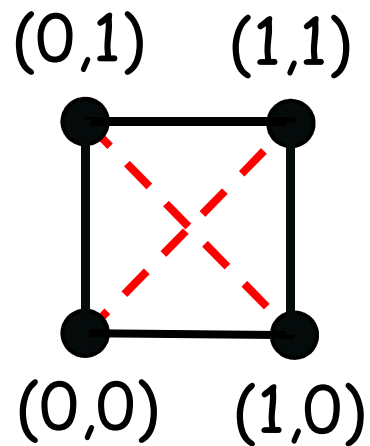



# Signed projective cubes

If  $d$  is odd,  $SPC_d$  is a *signed bipartite graph*.

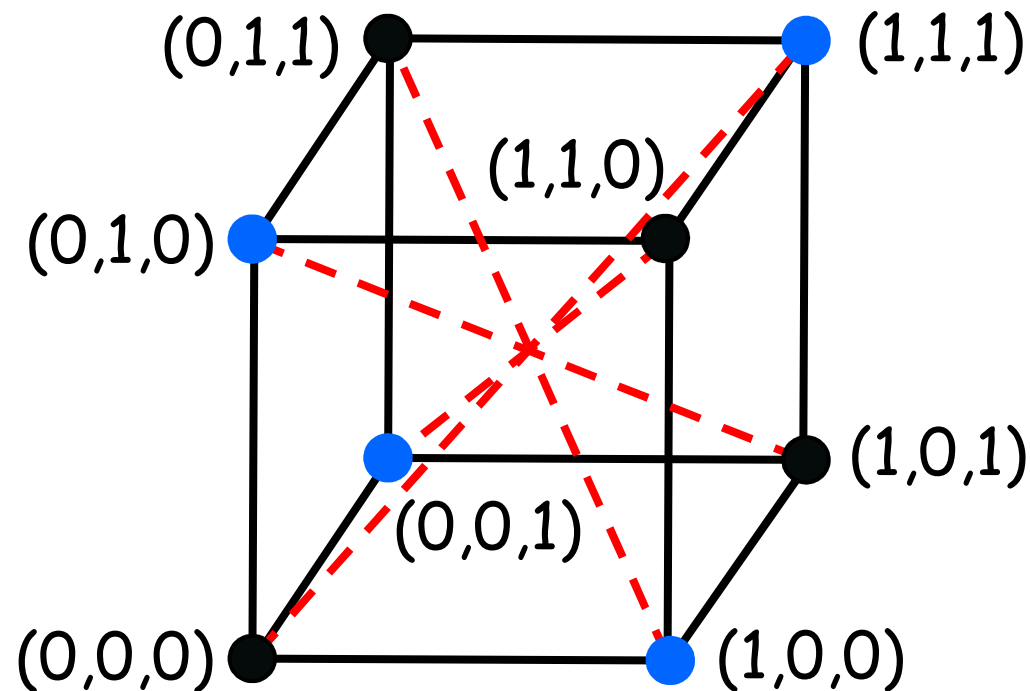

# Homomorphisms to $SPC_d$

If  $(G, \Sigma)$  admits a homomorphism to  $SPC_d$ , then:

- $(G, \Sigma)$  must be an *odd signed graph* if  $d$  is *even*,
- $(G, \Sigma)$  must be a *signed bipartite graph* if  $d$  is *odd*.

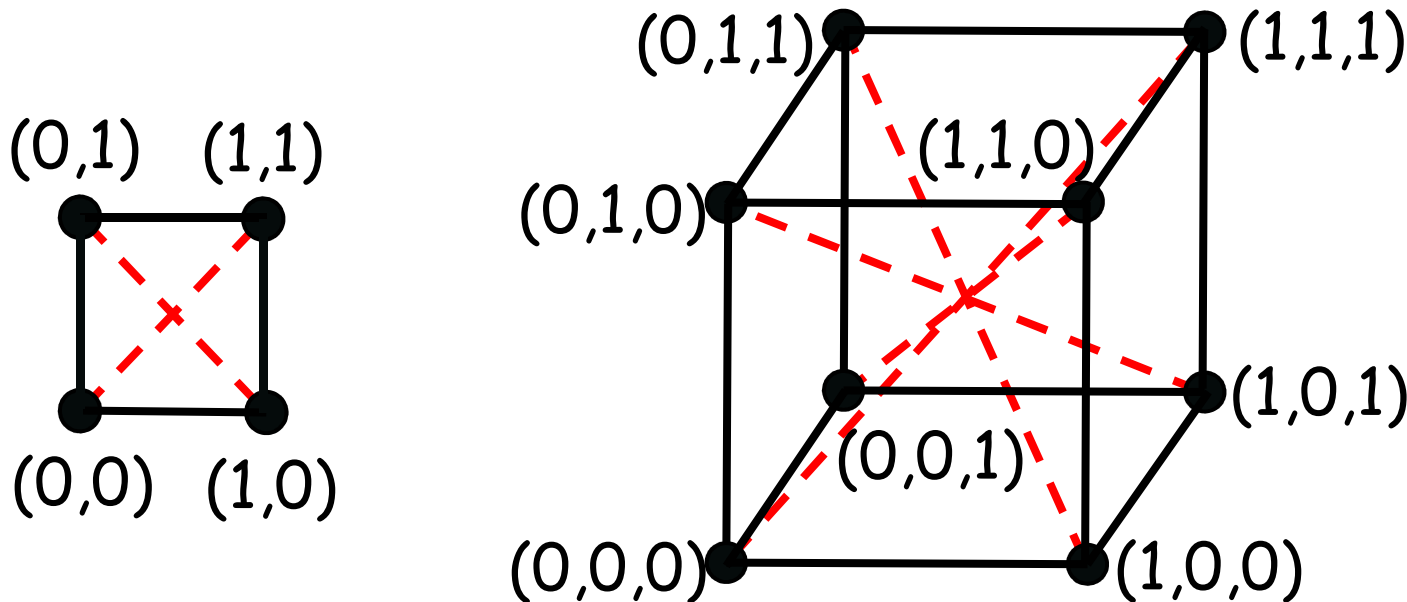

# Homomorphisms to $SPC_d$

If  $(G, \Sigma)$  admits a homomorphism to  $SPC_d$ , then:

- $(G, \Sigma)$  must be an *odd signed graph* if  $d$  is *even*,
- $(G, \Sigma)$  must be a *signed bipartite graph* if  $d$  is *odd*.

The  $SPC_d$ -homomorphism problem is equivalent to a packing problem:

**Theorem (Guenin, 2005).** A consistent signed graph admits a homomorphism to  $SPC_d$  iff it admits at least  $d$  edge-disjoint signatures.

# Homomorphisms to $SPC_d$

The **unbalanced girth** of  $(G, \Sigma)$  is the shortest length of an unbalanced cycle of  $(G, \Sigma)$ .

# Homomorphisms to $SPC_d$

The **unbalanced girth** of  $(G, \Sigma)$  is the shortest length of an unbalanced cycle of  $(G, \Sigma)$ .

**Conjecture (Naserasr, 2007).** Every consistent planar signed graph with unbalanced girth  $k$  admits a homomorphism to  $SPC_{k-1}$ .

# Homomorphisms to $SPC_d$

The **unbalanced girth** of  $(G, \Sigma)$  is the shortest length of an unbalanced cycle of  $(G, \Sigma)$ .

**Conjecture (Naserasr, 2007).** Every consistent planar signed graph with unbalanced girth  $k$  admits a homomorphism to  $SPC_{k-1}$ .

This conjecture is related to a conjecture of Seymour...

# Seymour's Conjecture

**Conjecture (Seymour, 1975).** Every  $k$ -regular planar multigraph with no odd edge-cut of less than  $k$  edges is  $k$ -edge-colourable.

An odd  
edge-cut:

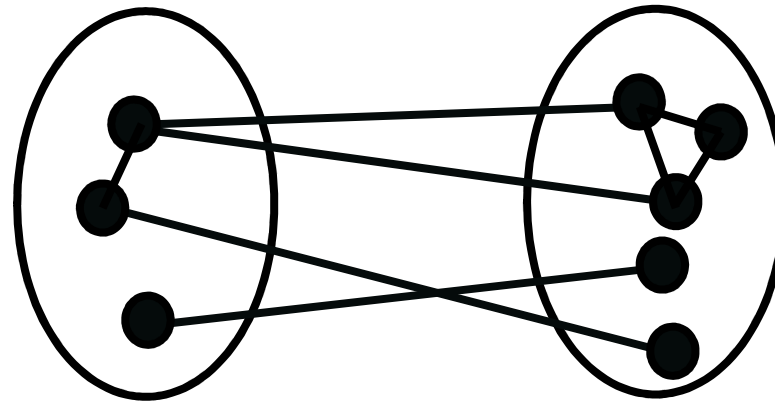

$X$  with  $|X|$  odd

$V(G) \setminus X$

# Seymour's Conjecture

**Conjecture (Seymour, 1975).** Every  $k$ -regular planar multigraph with no odd edge-cut of less than  $k$  edges is  $k$ -edge-colourable.

This conjecture, if true, generalizes the Four-Colour Theorem: for  $k = 3$ , it claims that every bridgeless cubic planar multigraph is 3-edge-colourable, which is equivalent to the Four-Colour Theorem by the result of Tait (1880).



# Seymour's Conjecture

**Conjecture (Seymour, 1975).** Every  $k$ -regular planar multigraph with no odd edge-cut of less than  $k$  edges is  $k$ -edge-colourable.

This conjecture has been proved for

- $k = 4, 5$ : Guenin (2003),
- $k = 6$ : Dvořák, Kawarabayashi & Král' (2010),
- $k = 7$ : Edwards & Kawarabayashi (2011),
- $k = 8$ : Chudnovsky, Edwards & Seymour (2012).

# Seymour's Conjecture

**Conjecture (Seymour, 1975).** Every  $k$ -regular planar multigraph with no odd edge-cut of less than  $k$  edges is  $k$ -edge-colourable.

**Conjecture (Naserasr, 2007).** Every consistent planar signed graph with unbalanced girth  $k$  admits a homomorphism to  $SPC_{k-1}$ .

# Seymour's Conjecture

**Conjecture (Seymour, 1975).** Every  $k$ -regular planar multigraph with no odd edge-cut of less than  $k$  edges is  $k$ -edge-colourable.

**Conjecture (Naserasr, 2007).** Every consistent planar signed graph with unbalanced girth  $k$  admits a homomorphism to  $SPC_{k-1}$ .

**Theorem (Naserasr, 2007 - Naserasr, Rollová, ES, 2013).** These two conjectures are equivalent.

# Seymour's Conjecture

Since Seymour's conjecture holds for  $k \leq 8$ , we get the following:

**Corollary.** Every planar signed bipartite graph of unbalanced girth 4 (resp. 6, 8) admits a homomorphism to  $SPC_3$  (resp.  $SPC_5$ ,  $SPC_7$ ).

# Seymour's Conjecture

In particular, since the unbalanced girth of every bipartite graph is at least 4:

**Corollary.** Every planar signed bipartite graph admits a homomorphism to  $SPC_3 \cong (K_{4,4}, M)$ .

# Seymour's Conjecture

In particular, since the unbalanced girth of every bipartite graph is at least 4:

**Corollary.** Every planar signed bipartite graph admits a homomorphism to  $SPC_3 \cong (K_{4,4}, M)$ .

This is an extension of the Four-Colour Theorem, since  $\chi(G) \leq k$  if and only if  $S(G) \rightarrow (K_{k,k}, M)$ ...

The chromatic number  
of signed graphs

# Chromatic number

Recall that the chromatic number  $\chi(G)$  of a graph  $G$  can equivalently be defined as the smallest order of a graph  $H$  such that  $G \rightarrow H$ .



# Chromatic number

Recall that the chromatic number  $\chi(G)$  of a graph  $G$  can equivalently be defined as the smallest order of a graph  $H$  such that  $G \rightarrow H$ .

Similarly, we can thus define the chromatic number  $\chi(G, \Sigma)$  of a signed graph  $(G, \Sigma)$  as the smallest order of a graph  $H$  such that  $(G, \Sigma) \rightarrow (H, T)$  for some signature  $T$  of  $H$ .

# Chromatic number

Recall that the chromatic number  $\chi(G)$  of a graph  $G$  can equivalently be defined as the smallest order of a graph  $H$  such that  $G \rightarrow H$ .

Similarly, we can thus define the chromatic number  $\chi(G, \Sigma)$  of a signed graph  $(G, \Sigma)$  as the smallest order of a graph  $H$  such that  $(G, \Sigma) \rightarrow (H, T)$  for some signature  $T$  of  $H$ .

Note that if  $(G, \Sigma) \rightarrow (G', \Sigma')$  then  $\chi(G, \Sigma) \leq \chi(G', \Sigma')$ .

# $K_4$ -minor free graphs

**Theorem (Naserasr, Rollová, ES, 2012+).**

For every  $K_4$ -minor free graph  $G$  and signature  $\Sigma$  on  $G$ ,  $(G, \Sigma) \rightarrow ST_5$ , so that  $\chi(G, \Sigma) \leq 5$ .

Moreover, this bound is tight.

# $K_4$ -minor free graphs

**Theorem (Naserasr, Rollová, ES, 2012+).**

For every  $K_4$ -minor free graph  $G$  and signature  $\Sigma$  on  $G$ ,  $(G, \Sigma) \rightarrow ST_5$ , so that  $\chi(G, \Sigma) \leq 5$ .

Moreover, this bound is tight.

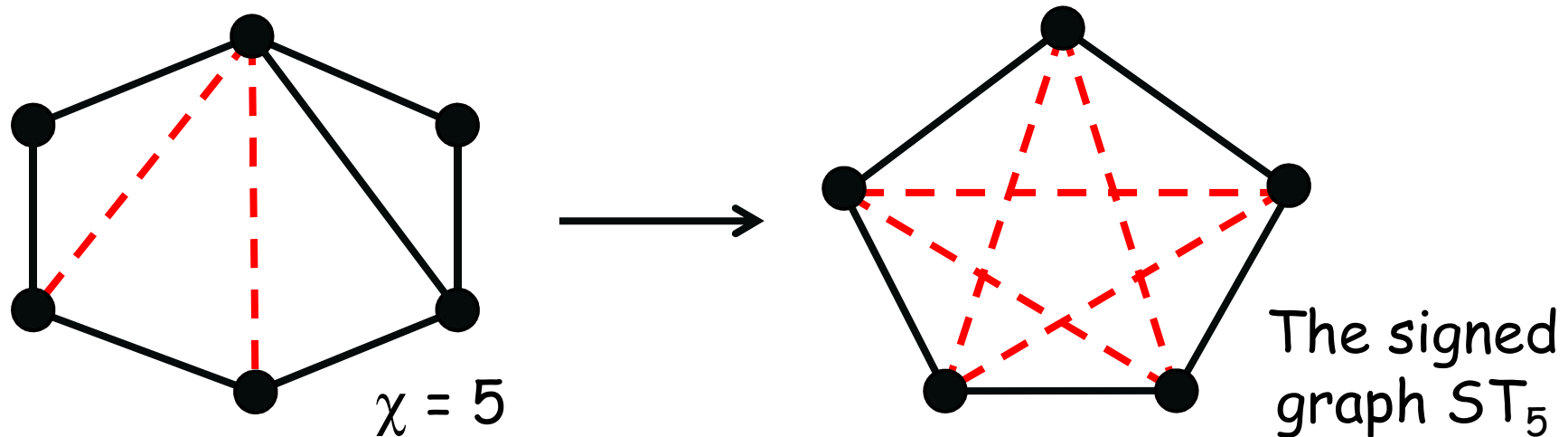

# Planar graphs

An **acyclic colouring** of a graph  $G$  is a proper colouring of  $G$  such that any two colours induce a *forest* (in other words, each *cycle* of  $G$  uses *at least 3 colours*).

# Planar graphs

An **acyclic colouring** of a graph  $G$  is a proper colouring of  $G$  such that any two colours induce a *forest* (in other words, each *cycle* of  $G$  uses *at least 3 colours*).

**Theorem (Ochem, Pinlou, Sen, 2012+).**

If  $G$  is acyclically  $k$ -colorable then, for every signature  $\Sigma$  on  $G$ ,  $\chi(G, \Sigma) \leq k \cdot 2^{k-2}$ .



# Planar graphs

An **acyclic colouring** of a graph  $G$  is a proper colouring of  $G$  such that any two colours induce a *forest* (in other words, each *cycle* of  $G$  uses *at least 3 colours*).

**Theorem (Ochem, Pinlou, Sen, 2012+).**

If  $G$  is acyclically  $k$ -colorable then, for every signature  $\Sigma$  on  $G$ ,  $\chi(G, \Sigma) \leq k \cdot 2^{k-2}$ .

**Corollary.** If  $G$  is planar, then  $\chi(G, \Sigma) \leq 40$ .

# Planar graphs

The following planar signed graph has 12 vertices and chromatic number 10:

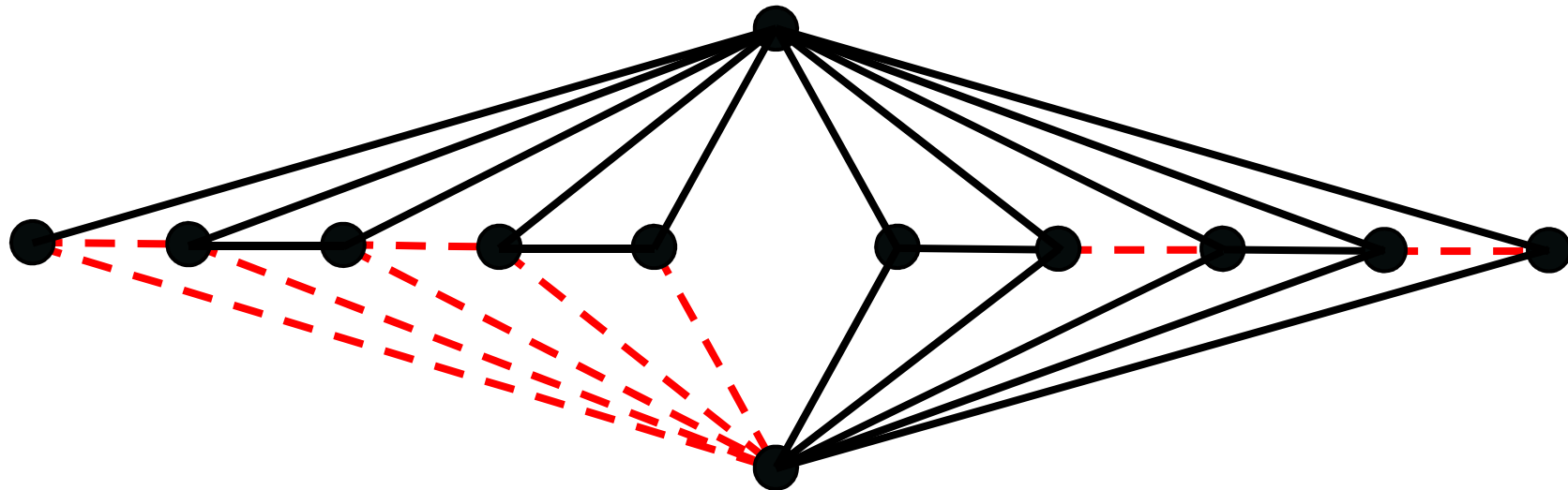



# Complexity

**Problem:** K-CHROMATIC-SIGNED-GRAPH

**Input:** A signed graph  $(G, \Sigma)$ .

**Question:** Is  $\chi(G, \Sigma) \leq k$ ?

# Complexity

**Problem:** K-CHROMATIC-SIGNED-GRAPH

**Input:** A signed graph  $(G, \Sigma)$ .

**Question:** Is  $\chi(G, \Sigma) \leq k$ ?

**Proposition.** The problem K-CHROMATIC-SIGNED-GRAPH is polynomial for  $k = 1, 2$  and NP-complete for  $k \geq 3$ .

# Complexity

**Problem:** K-CHROMATIC-SIGNED-GRAPH

**Input:** A signed graph  $(G, \Sigma)$ .

**Question:** Is  $\chi(G, \Sigma) \leq k$ ?

**Proposition.** The problem k-CHROMATIC-SIGNED-GRAPH is polynomial for  $k = 1, 2$  and NP-complete for  $k \geq 3$ .

- $\chi(G, \Sigma) \leq 2$  iff  $G$  is bipartite and  $(G, \Sigma)$  contains no unbalanced cycle
- k-CHROMATIC-SIGNED-GRAPH contains k-CHROMATIC-GRAPH

# S-cliques

An **S-clique** is a signed graph  $(G, \Sigma)$  such that  
$$\chi(G, \Sigma) = |V(G)|.$$

# S-cliques

An **S-clique** is a signed graph  $(G, \Sigma)$  such that  
$$\chi(G, \Sigma) = |V(G)|.$$

*This means that no two vertices can be identified in a homomorphic image of  $(G, \Sigma)$ ...*

# S-cliques

An **S-clique** is a signed graph  $(G, \Sigma)$  such that  
$$\chi(G, \Sigma) = |V(G)|.$$

**Proposition.** A signed graph  $(G, \Sigma)$  is an S-clique if and only if, for any two vertices  $u$  and  $v$ , either  $uv$  is an edge or  $u$  and  $v$  belong to some unbalanced 4-cycle.

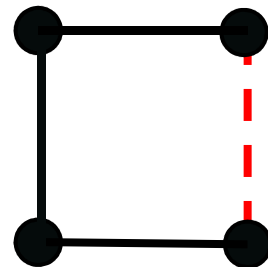

# S-cliques

**Proposition.** A signed graph  $(G, \Sigma)$  is an S-clique if and only if, for any two vertices  $u$  and  $v$ , either  $uv$  is an edge or  $u$  and  $v$  belong to some unbalanced 4-cycle.

Every  $(K_{n,n}, M)$ ,  $k \geq 3$ , is thus an S-clique...

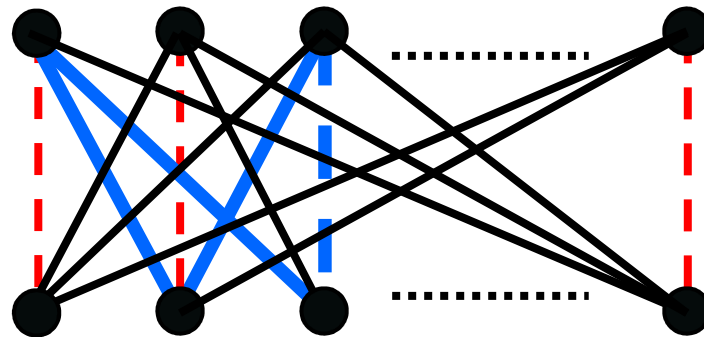

# S-cliques

This example shows that the difference between  $\chi(G)$  and  $\chi(G, \Sigma)$  can be arbitrarily large...

$$\chi(K_{n,n}) = 2$$

$$\chi(K_{n,n}, \mathcal{M}) = 2n$$

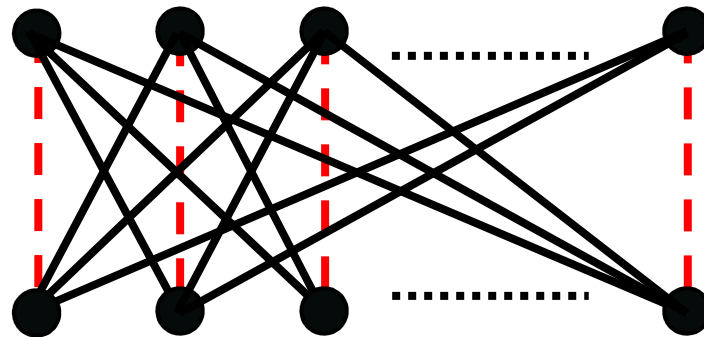



# S-clique numbers

The **absolute S-clique number**  $\chi_{as}(G, \Sigma)$  is the maximum order of an *S-clique subgraph* of  $(G, \Sigma)$ .

# S-clique numbers

The **absolute S-clique number**  $\chi_{as}(G, \Sigma)$  is the maximum order of an *S-clique subgraph* of  $(G, \Sigma)$ .

$$\chi_{as}(G, \Sigma) = 4$$

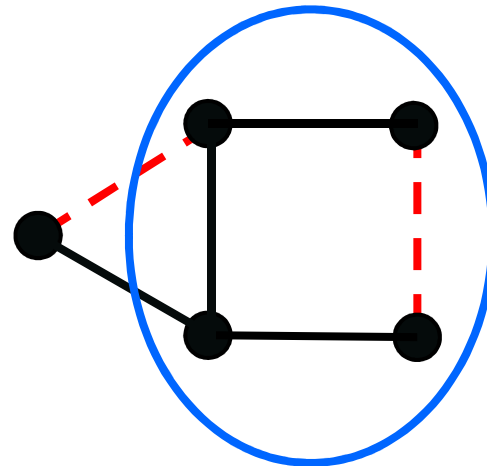

# S-clique numbers

The **relative S-clique number**  $\chi_{rs}(G, \Sigma)$  is the maximum size of a subset  $S$  of  $V(G)$  such that no two vertices in  $S$  can be *identified* in any homomorphic image of  $(G, \Sigma)$ .

# S-clique numbers

The **relative S-clique number**  $\chi_{rs}(G, \Sigma)$  is the maximum size of a subset  $S$  of  $V(G)$  such that no two vertices in  $S$  can be *identified* in any homomorphic image of  $(G, \Sigma)$ .

$$\chi_{rs}(G_k, \Sigma) = k$$

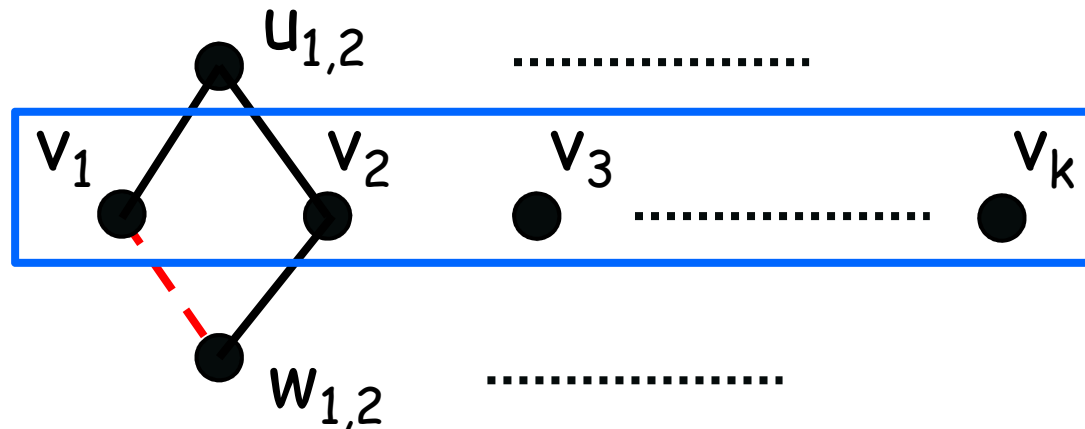

*For every  $v_i, v_j$ , create a  $UC_4$  using new vertices  $u_{i,j}$  and  $w_{i,j}$ ...*

# S-clique numbers

The difference

$$\chi_{rs}(G, \Sigma) - \chi_{as}(G, \Sigma)$$

can be arbitrarily large...

$$\chi_{as}(G_k, \Sigma) = 4$$

$$\chi_{rs}(G_k, \Sigma) = k$$

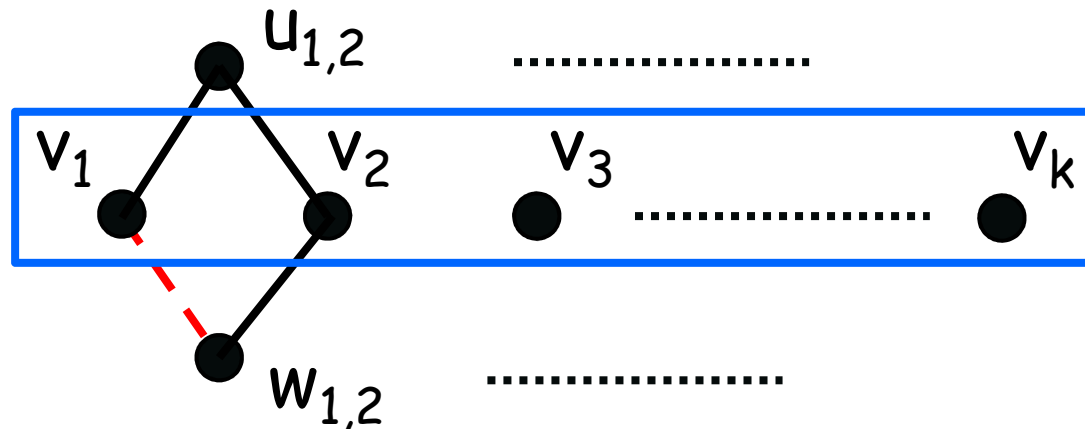

*For every  $v_i, v_j$ , create a  $UC_4$  using new vertices  $u_{i,j}$  and  $w_{i,j}$ ...*

# S-clique numbers

## Proposition.

For every signed graph  $(G, \Sigma)$ :

$$\chi_{as}(G, \Sigma) \leq \chi_{rs}(G, \Sigma) \leq \chi(G, \Sigma).$$

# S-clique numbers

## Proposition.

For every signed graph  $(G, \Sigma)$ :

$$\chi_{as}(G, \Sigma) \leq \chi_{rs}(G, \Sigma) \leq \chi(G, \Sigma).$$

Note that computing any of these S-clique numbers is NP-hard, since both these problems contain the problem of computing the clique number of a graph (simply set  $\Sigma = \emptyset$ )...

# Planar $S$ -cliques

**Theorem (Naserasr, Rollová, ES, 2012+).**  
The maximum order of a planar  $S$ -clique is 8.



# Planar $S$ -cliques

**Theorem (Naserasr, Rollová, ES, 2012+).**  
The maximum order of a planar  $S$ -clique is 8.

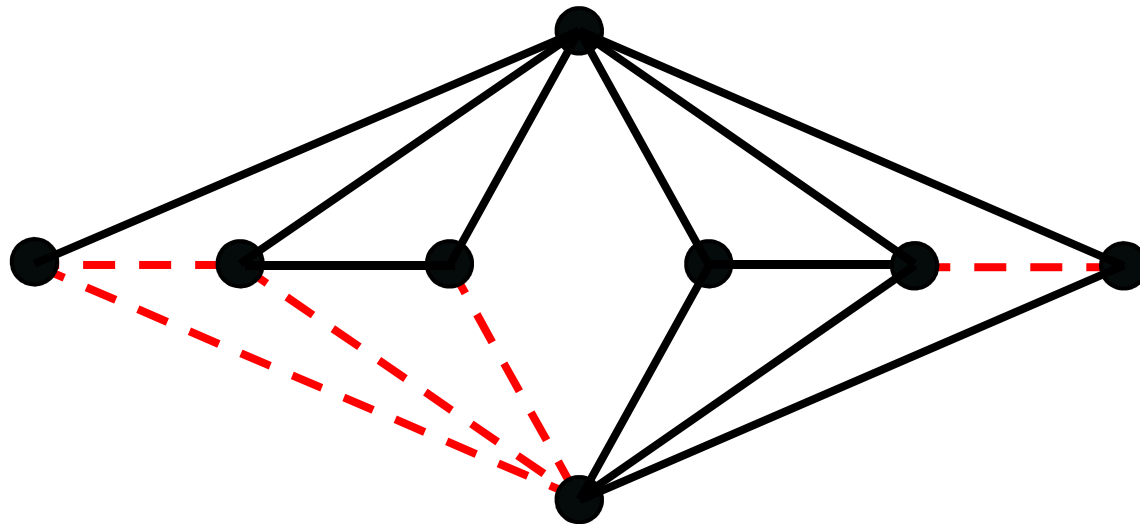

A planar  $S$ -clique of order 8

Open questions

# A few open questions...

1. Determine the maximum chromatic number of a planar signed graph (lies between 10 and 40).
2. Determine the optimal bound for  $\chi_{rs}(G, \Sigma)$  when  $G$  is planar (the optimal bound for  $\chi_{as}$  is 8).
3. Is it true that if  $G$  is bipartite and  $(G, \Sigma)$  has no  $(K_4, E(K_4))$  as a minor, then  $(G, \Sigma) \rightarrow (K_{3,3}, M)$ ?
4. Is it true that every consistent planar signed graph with unbalanced girth  $k$  admits a homomorphism to  $SPC_{k-1}$ ? (equivalent to Seymour's conjecture...)

Thank you for your  
attention...