



Canonical Graph Decompositions
for
algorithms and graph structure

Bruno Courcelle

Université Bordeaux 1, LaBRI and

Institut Universitaire de France

Graph decompositions

1. Essential tool for constructing algorithms.
2. Give structural descriptions that help to prove properties (e.g., the Graph Minor Theorem).

-- Tree-decompositions,

-- Rank-decompositions and clique-width expressions yield FPT algorithms.

These decompositions are *not canonical* (hence “difficult” to construct).

Canonical decompositions

Useful as preprocessing in many cases,
and also to describe certain “features”.

	Construction time	Algos / Descriptions
Modular decomp. Undirected Directed	 $O(n + m)$ $O(n + m)$	Clique-width $\leq k$, interval graphs and related ones, cluster editing, genomics, opt. problems for comparability graphs. All transitive orientations of a comparability graph,
Split decomposition Undirected Directed	 $O(n + m \cdot \alpha(n+m))$ $O(m \cdot \log(n))$	Rank-width $\leq k$, circle graphs, 3-leaf powers, distance labelling, coloring and optimization problems. All chord diagrams of a circle graph.

Tutte decomp. (3-connected comp.)	$O(n+m)$	Tree-width $\leq k$. All planar embeddings of a planar graph.
Atomic decomposition	$O(n+m)$	Number of strongly connected orientations, Gauss words, Knots, Matroids ???

Many authors : Hopcroft, Tarjan,

Most recent algorithms : Charbit, Corneil, Gioan, Habib, Joeris, Lundberg, McConnell, de Montgolfier, Paul, Raffinot, Rao, Tedder, ...

Descriptions *via* canonical decompositions

Example : All planar embeddings of a planar graph.

1. The components of the **Tutte decomposition** are 3-connected graphs, cycles and “bonds”
(sets of parallel edges).
2. 3-connected planar graphs and cycles have **unique** planar embeddings.
3. Bonds have planar embeddings described by permutations.
4. The embeddings of the components can be combined into one of the given graph.

Similar situations :

1. All transitive orientations of a comparability graph:

using the **modular decomposition** :

a *prime module* has a **unique** transitive orientation (up to reversal); the other components are edgeless and cliques (all linear orders fit).

2. All chord diagrams of a circle graph :

using the **split decomposition** :

a *prime component* has a **unique** chord diagram (up to flipping, rotation); the others are as above (their chord diagrams are defined from linear orders).

The atomic decomposition of a strongly connected graph

Different from the *split decomposition* of the same graphs by Cunningham (1982).

Close to the *Tutte decomposition*.

The subgraphs G_i are its *atoms*.

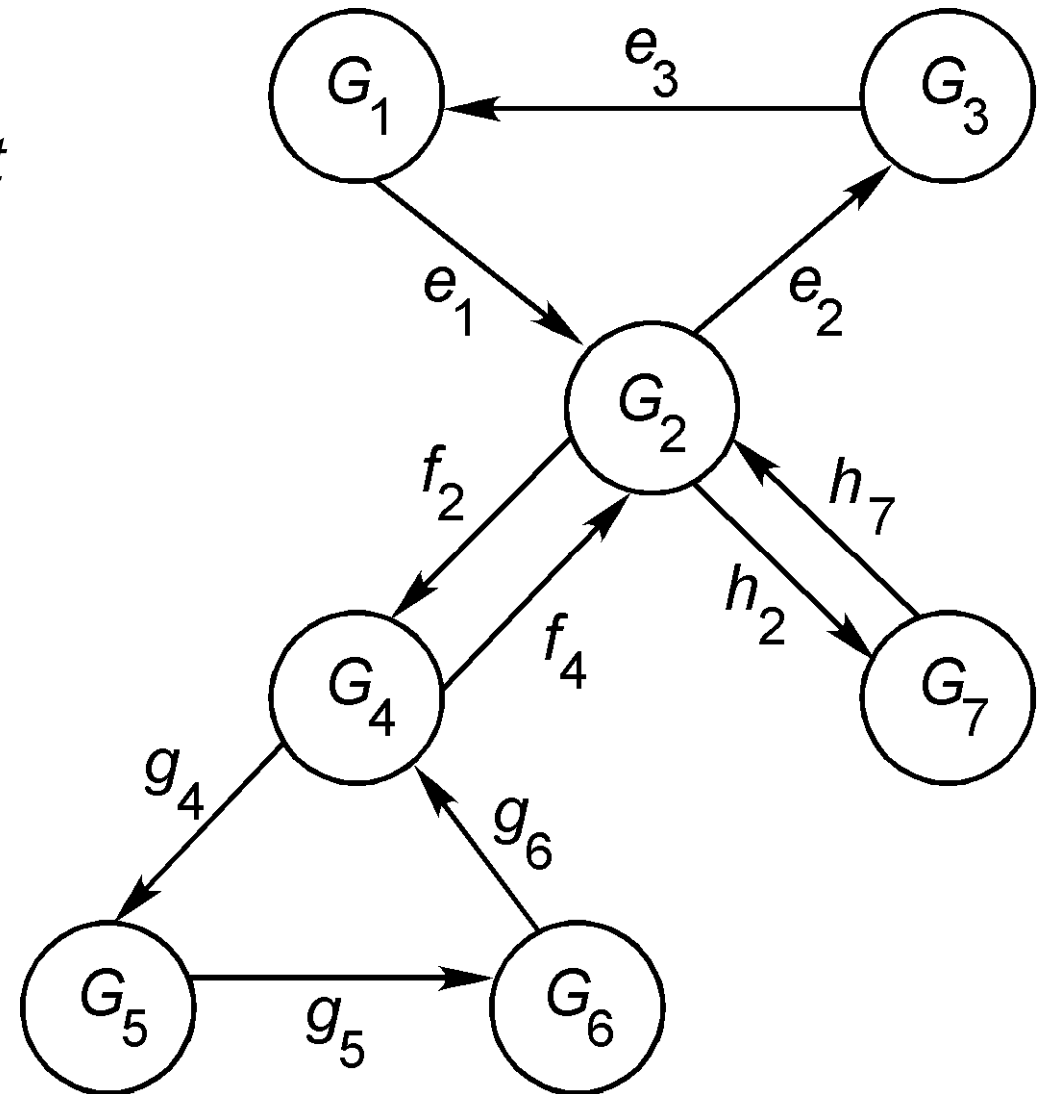

Motivation : Gauss words describing intersections of curves

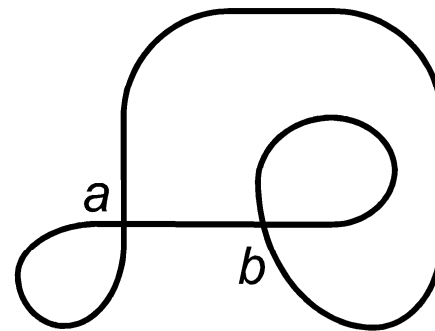
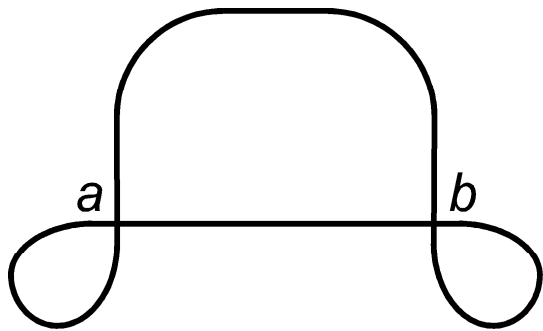

word : aabb

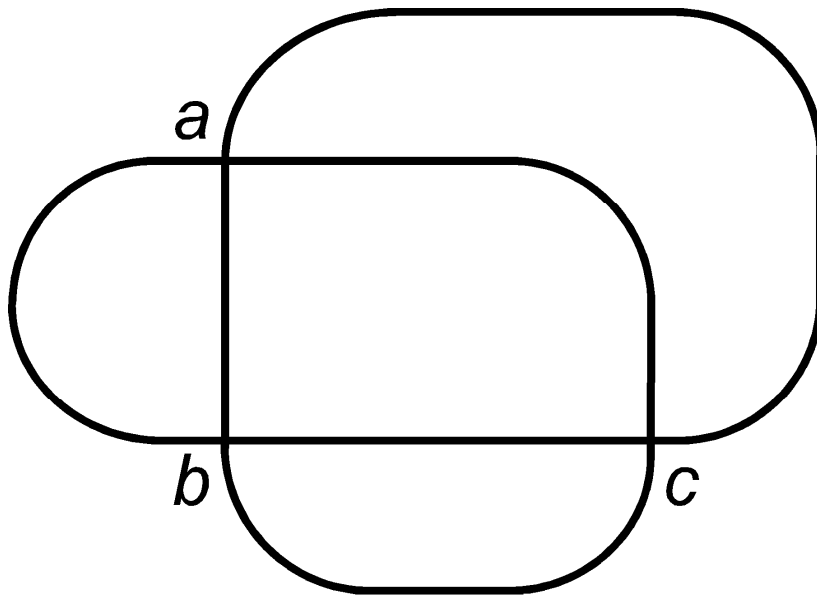

word : abcabc

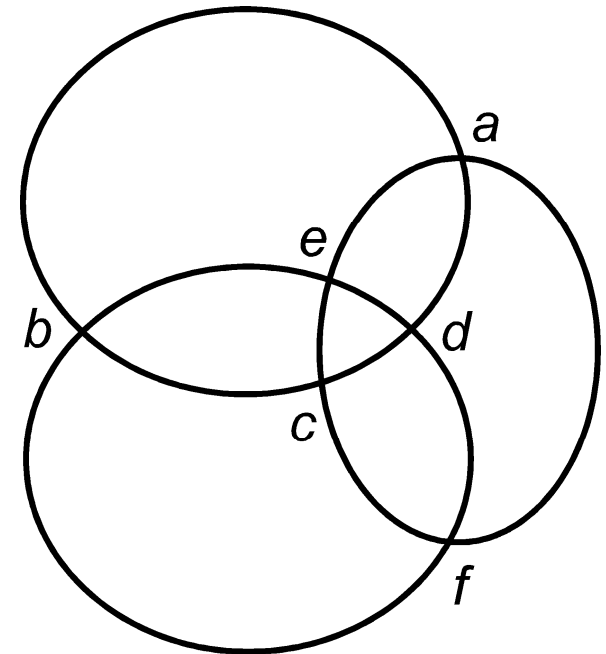

multiword : (abcd, bfde, aecf)

Question : Can one describe all (tuples of) curves
(up to homeomorphism) corresponding to a given Gauss
(multi)word ?

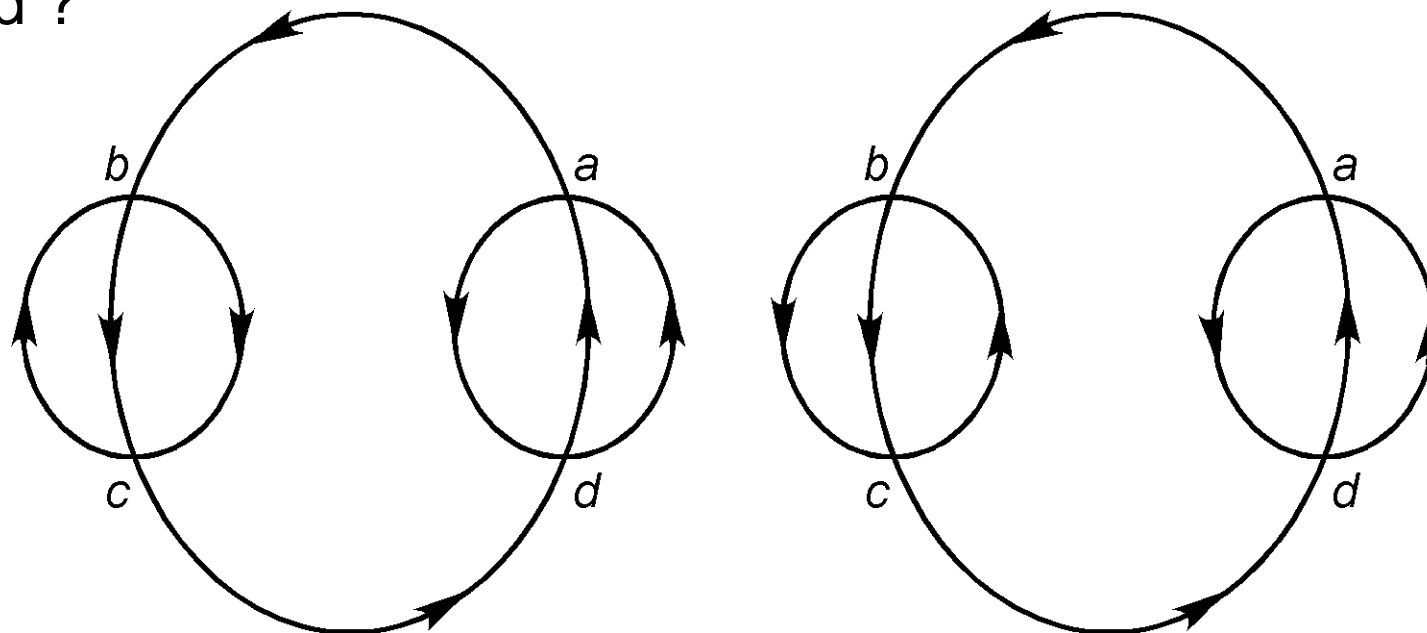

An **ambiguous** multiword $(abcd, bc, ad)$ (the circle “bc” is “flipped”).

It is **not** ambiguous for nonoriented curves (invariance under flipping).

Method : A multiword W yields a (2,2)-regular graph $\text{Gra}(W)$ with *transitions*.

Ex.: $\text{Gra}(Z)$ for
 $Z = (abcd, akcbkd)$

What are the planar embeddings of $\text{Gra}(W)$ that respect its transitions ?

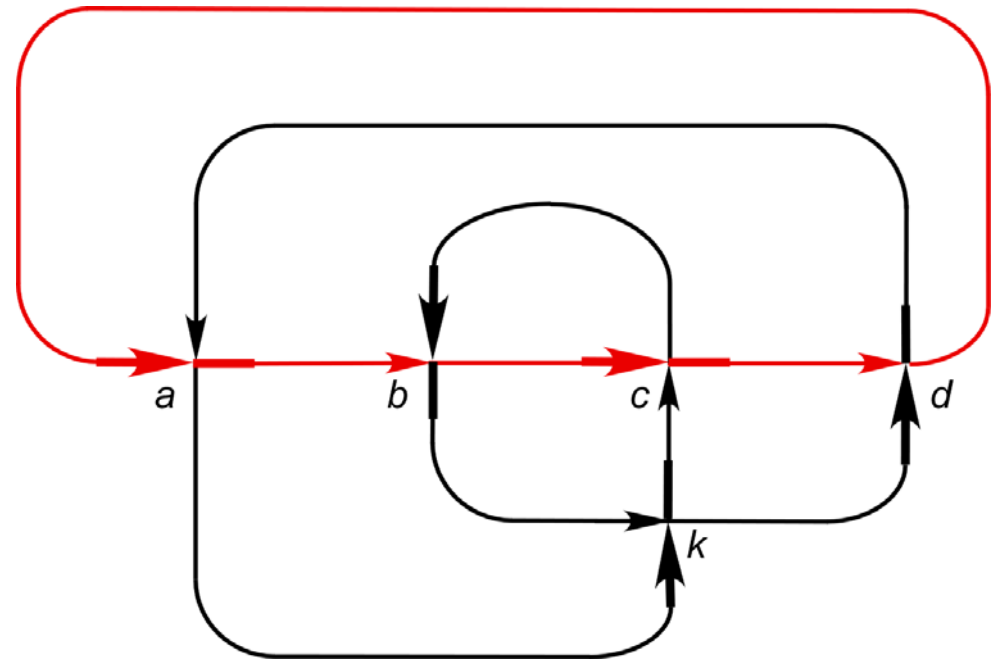

Planarity of (2,2)-regular t -graphs (t means “with transitions”)

Can be checked in **linear time**.

(Easy reduction to the usual planarity test).

Circular composition of graphs, t-graphs and maps

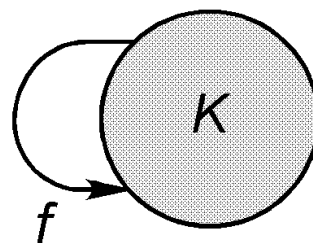
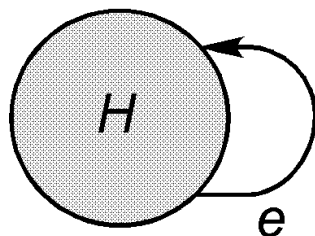

$$G = H \boxplus_{e,f} K$$

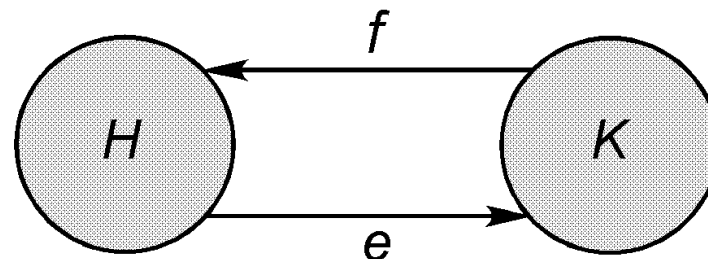

Atoms : those that cannot be decomposed (as G)

Theorem : A planar t-atom has a **unique** planar embedding.

By “flipping” the embedding of K , one gets a different embedding of the t-graph G . (Flipping is like turning over a pancake.)

Examples of *t*-atoms :

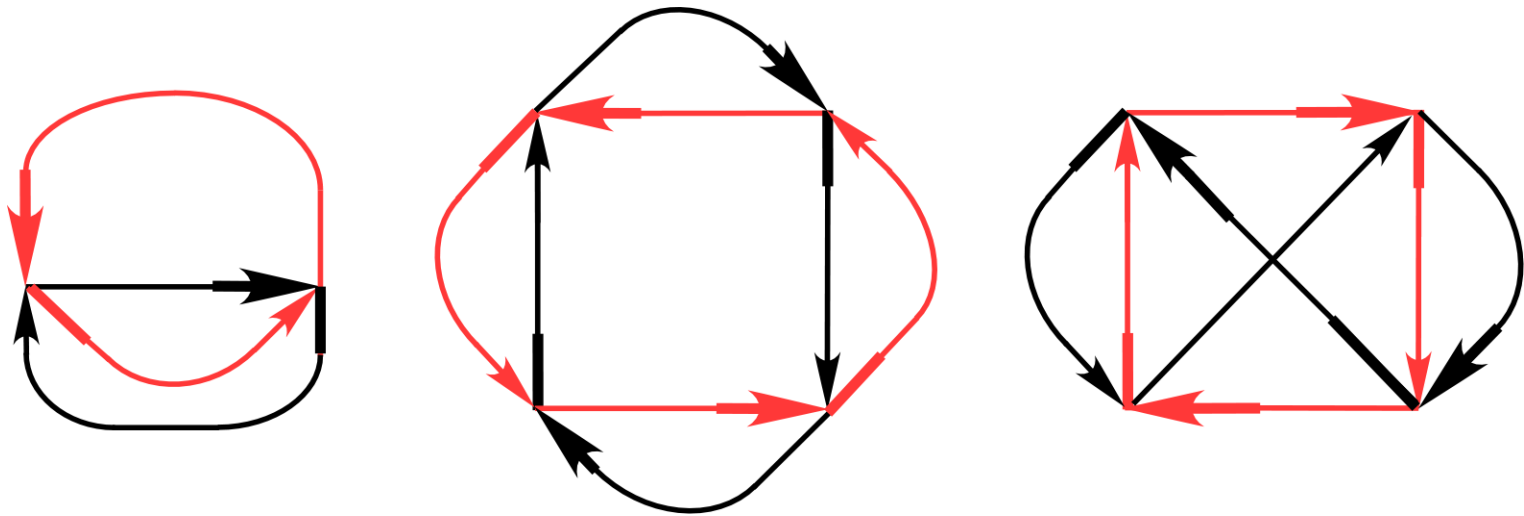

not planar
(as *t*-atom;
the graph is planar).

Circular composition satisfies some laws (*circular associativity*).

Graphs and *not trees*, represent “normal forms” of terms.

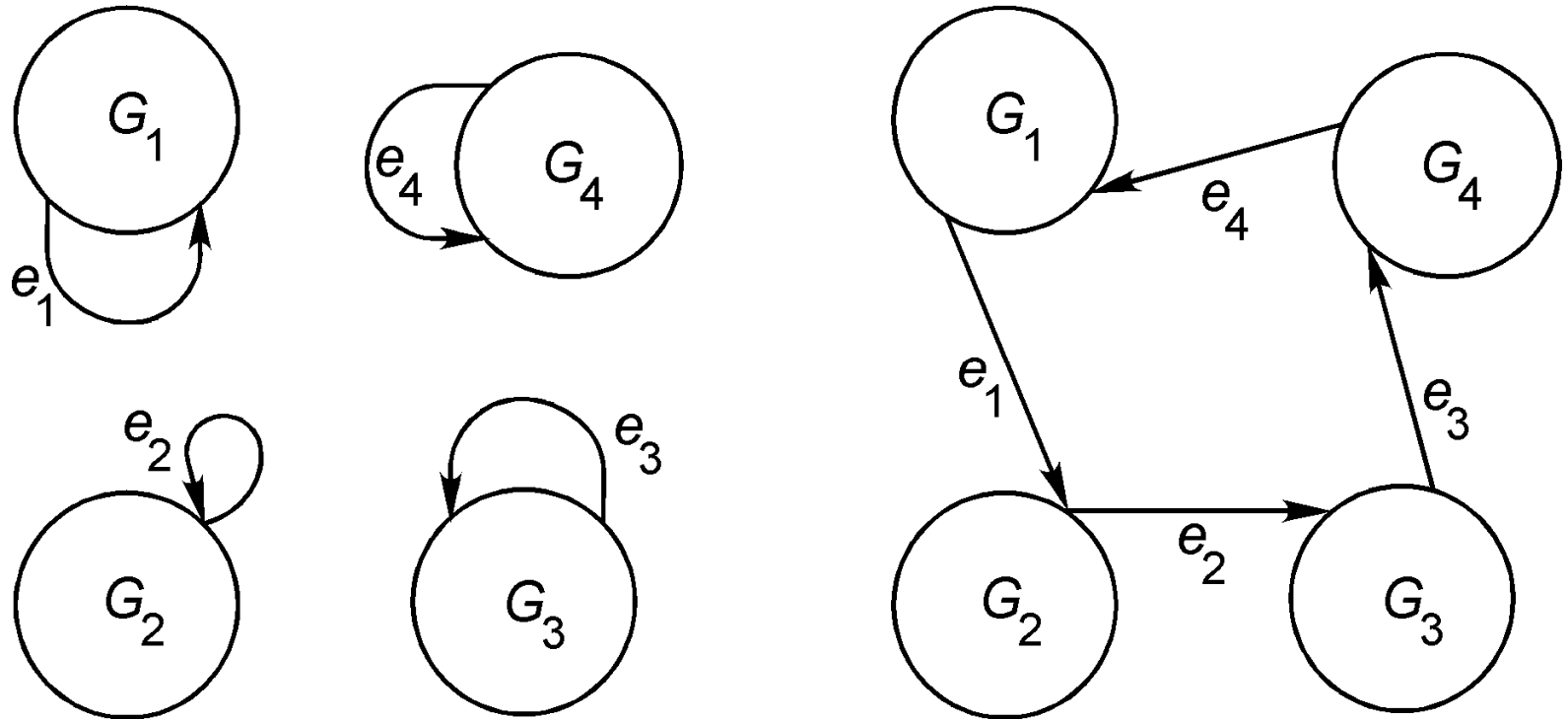

Circular composition $\boxplus_{e_1, e_2, e_3, e_4} (G_1, G_2, G_3, G_4)$ defined as

$$((G_1 \boxplus_{e_1, e_2} G_2) \boxplus_{e_2, e_3} G_3) \boxplus_{e_3, e_4} G_4$$

Two vertices belong to an atom \leftrightarrow they are not **separated** by an “edge-cut” of 2 edges.

The quotient graph is a *cactus* :

It defines the

atomic decomposition.

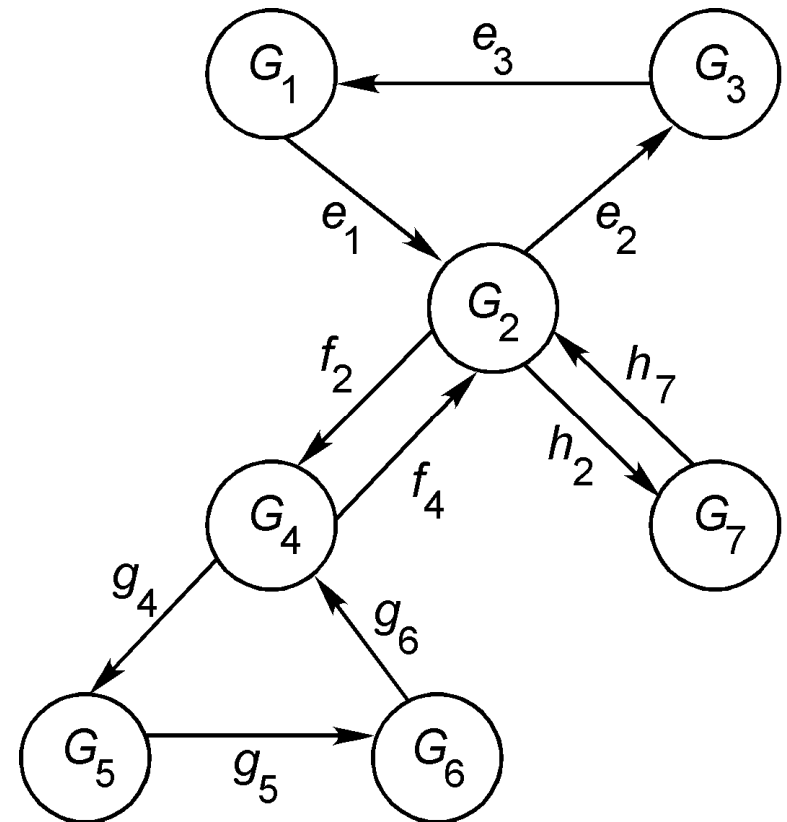

Def. of cactus : The 2-connected components are circuits.

Equiv. : for all x,y , there is a **unique path** from x to y

(the directed version of one characterization of undirected trees).

The Tutte decomposition of a 2-connected graph:

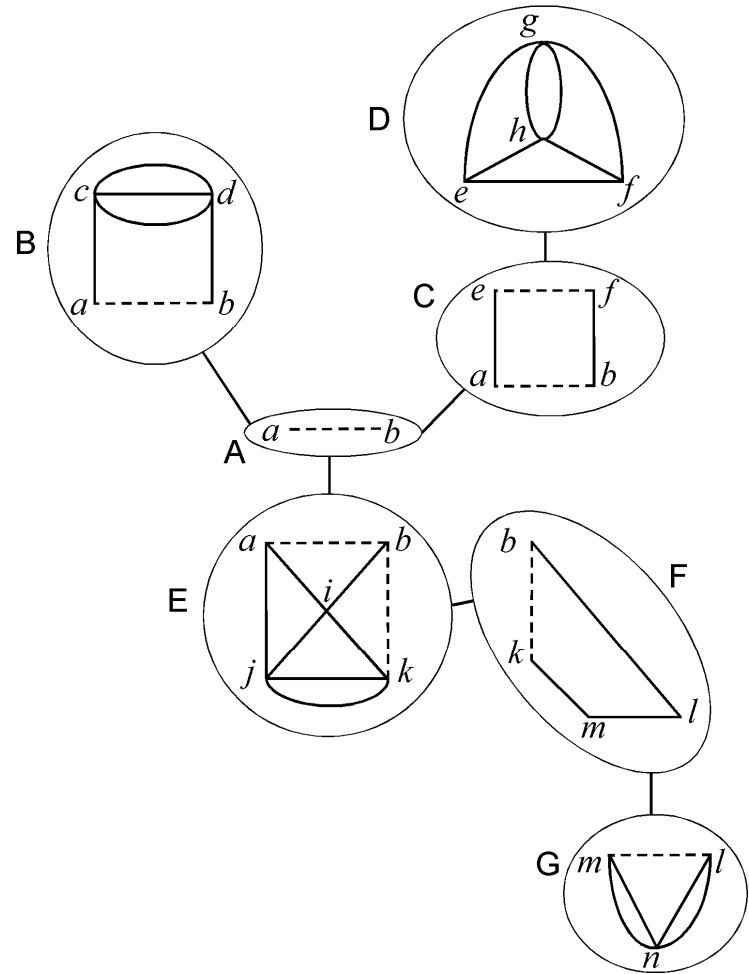
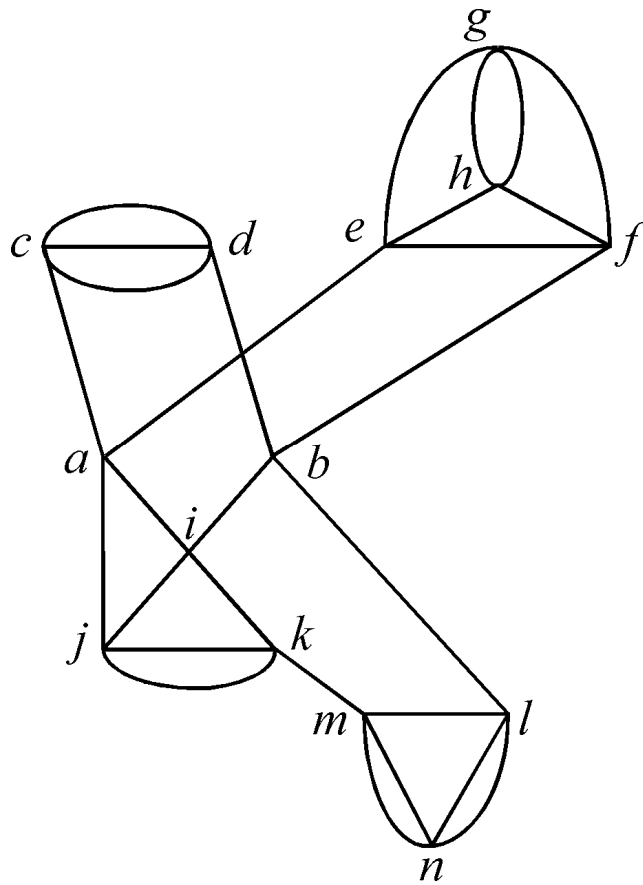

The *blocks* have vertex sets $\{c,d\}$, $\{a,b,i,j,k\}$, $\{e,f,g,h\}$, $\{l,m,n\}$.

Atoms determined from the Tutte decomposition

- u and v are **separated** at block B by $\{e, f\}$
- v and w are **not** separated at block B by $\{e, f\}$

An atom is not in general a (subgraph of a) **block** of the Tutte decomposition.

The atomic decomposition can

be computed in linear time from the Tutte decomposition.

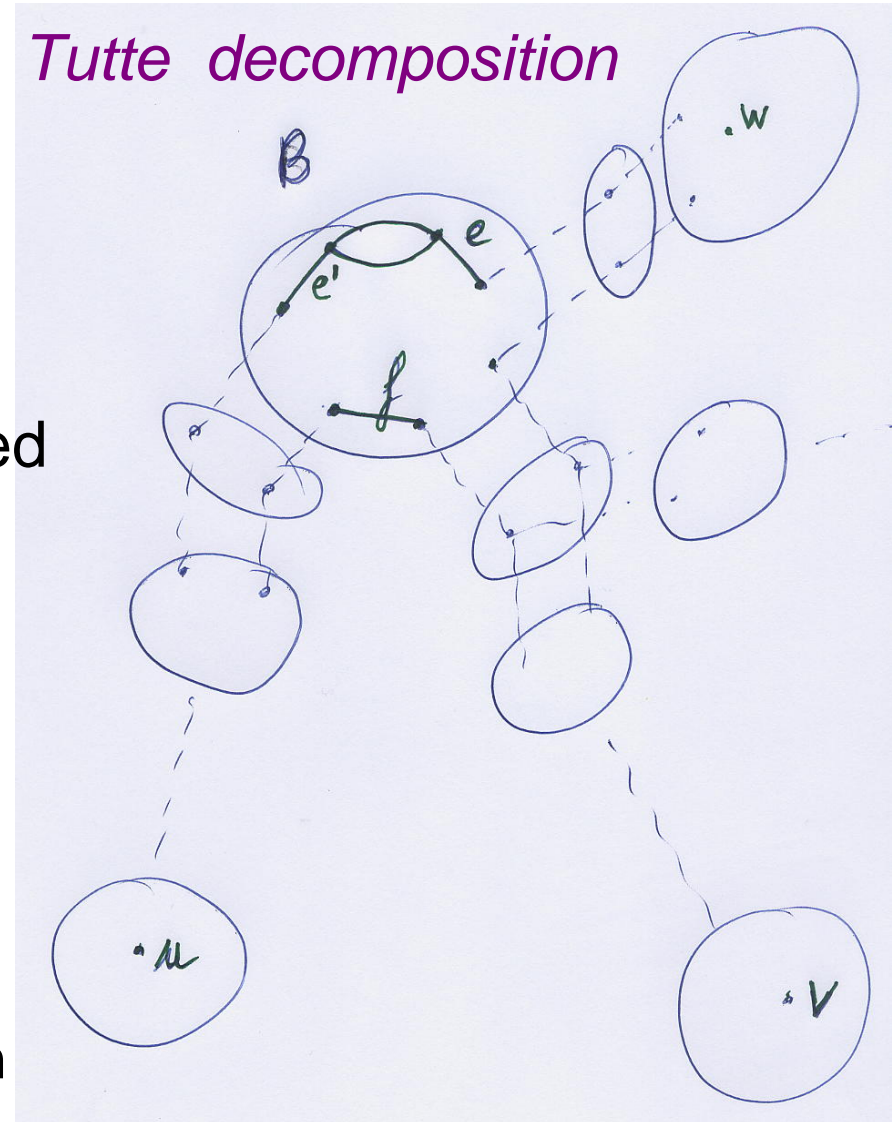

What about undirected graphs ?

The 2-edge connected graphs (*equiv.*: connected without bridges) are those having a strongly connected orientation.

The atomic decomposition is (essentially) *invariant* under a change of strongly connected orientation. Because so are the notions of *separation of 2 vertices* and of atom .

$$G = H \boxplus_{e,f} K$$

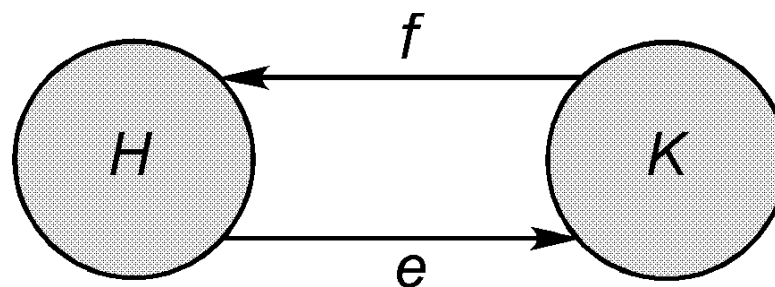

Idea : If one reverses e , one must also reverse f to keep a strongly connected orientation.

Application: Number of strongly connected (or of Eulerian orientations), denoted by $\#(G)$.

Fact:

$$G = H \boxplus_{e,f} K \quad \rightarrow \quad \#(G) = \#(H) \cdot \#(K) / 2$$

Hence if G has atoms H_1, \dots, H_p , then :

$$\#(G) = \#(H_1) \cdot \dots \cdot \#(H_p) / 2^{p-1}$$

oOo

Relation to tree-width :

$\text{twd}(G) =$ Maximum tree-width of the atoms of G

(if $\text{twd}(G) \geq 2$)

Application to Gauss multiwords

1. For multiword W , construct the t -graph $\text{Gra}(W)$.

Ex.: $\text{Gra}(Z)$ for

$Z = (abcd, akcbkd)$

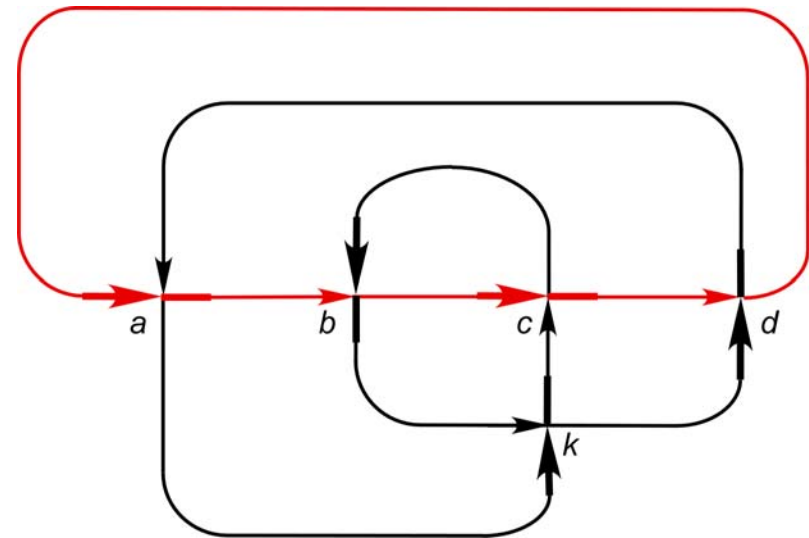

2. Check if $\text{Gra}(W)$ is planar ; check if it is a t -atom.

3. If planar, build the atomic decomposition (trivial if atom).
4. Build the unique planar embedding of each **t**-atom.
5. By flipping each of the p **t**-atoms, we get the 2^{p-1} different planar embeddings of **Gra(W)**.

All these tasks can be done by **linear time** algorithms.

Gauss multiwords representing tuples of **nonoriented** curves

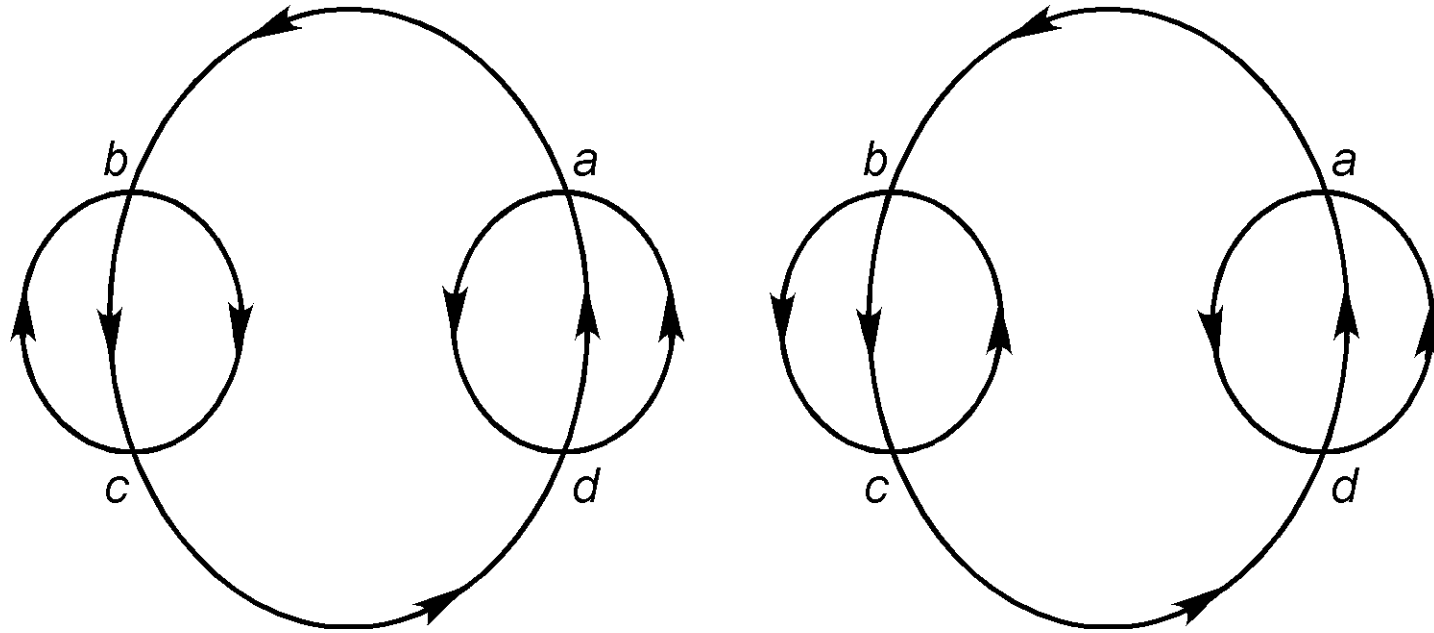

The multiword $(abcd, bc, ad)$ is ambiguous for oriented curves but not for nonoriented ones. The problem comes **(only)** from **small curves**: those with 2 intersections.

Both orientations of the small red curve give the same multiword.

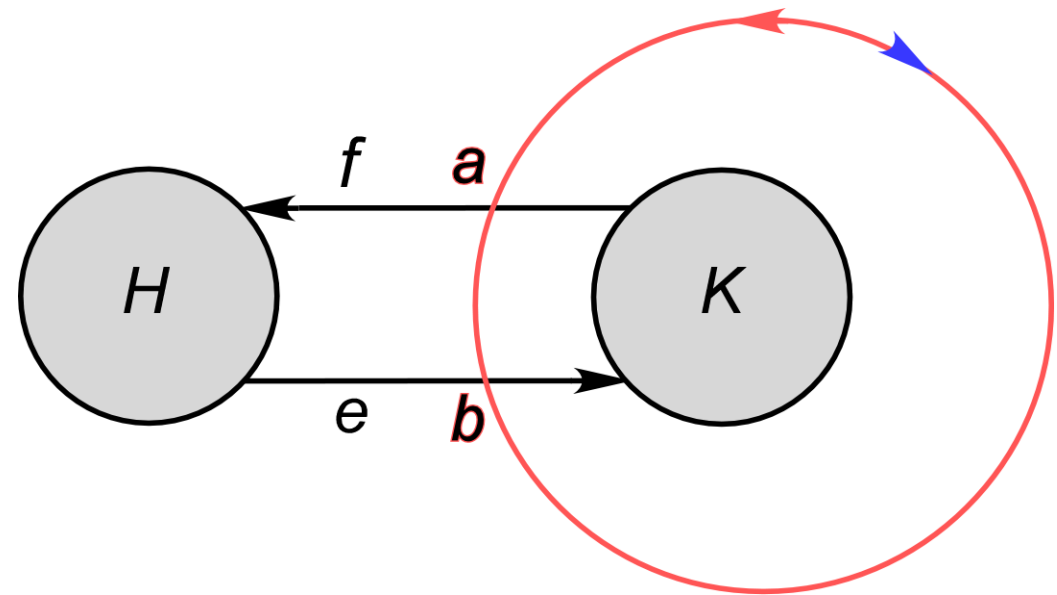

$$W = (\mathbf{ab}, w_1, \dots, w_n) \rightarrow W' = (w'_1, \dots, w'_n) \quad (\text{we remove } \mathbf{a,b})$$



\mathbb{N} tuples of nonoriented \leftarrow \mathbb{N} planar embeddings of $\text{Und}(\text{Gra}(W'))$
 curves for W .

General case for nonoriented curves

Theorem: If W is a Gauss multiword of the form

$W = (ab, \dots, cd, w_1, \dots, w_n) \rightarrow W' = (w'_1, \dots, w'_n)$ (removing a, b, \dots, c, d),

w_1, \dots, w_n have length ≥ 3 (actually ≥ 4 by planarity),

if W has q small components : ab, \dots, cd ,

then $\text{Gra}(W')$ has p t -atoms, and

there are 2^{p-q-1} $(q+n)$ -tuples of nonoriented curves with Gauss multiword W .

Remark: Each small component yields a t -atom, whence the number $p-q$.

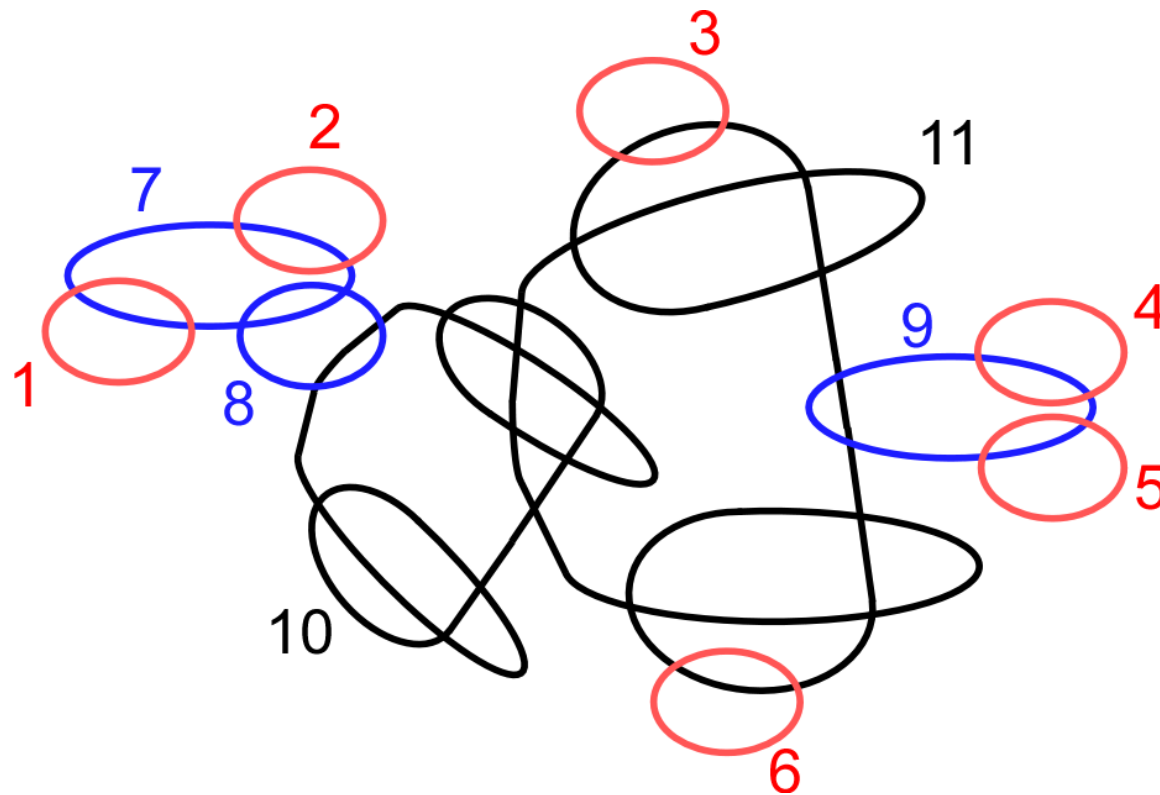

There are 6 small components (in red).

The remaining curves (in black and blue) represent

$\text{Gra}(W')$ that has 7 atoms \rightarrow 64 different 11-tuples of curves

Extensions and open questions

Curves with **multiple intersections**,

Knot diagrams,

Decompositions based on circular composition
of **directed graphs**,

Gauss multiwords on other **surfaces**,

Forbidden configurations (minors ?) for planar
4-regular graphs with transitions,

Algorithmic applications ? Thanks for suggestions !

Artistic applications: Possible.

Find grammar for the
Gauss words
of **kolams** ?

