

COUNTING WITH $AB-BA=1$

PHILIPPE FLAJOLET,

ROCQUENCOURT

§

PAWEL BLASIAK,

KRAKÓW

“COMBINATORIAL MODELS OF ANNIHILATION-CREATION”; IN PREP. (2010)

From Quantum Physics (QED):

— **A** = **Annihilate** a “random” particle

— **B** = give **Birth** to a new particle

A .



=



+



+



B .



=

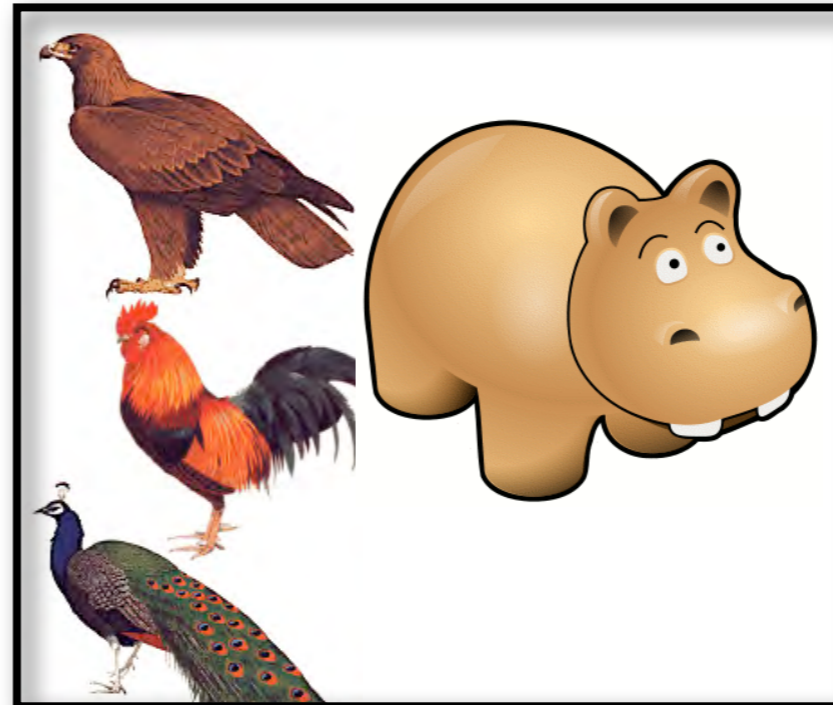

Annihilation and Creation

- **A** = **Annihilate** a “random” particle
- **B** = give **Birth** to a new particle $\longrightarrow \square$

$$\begin{aligned} \text{—} \quad \mathbf{AB}\mathcal{F} &= \mathbf{A}(\square\mathcal{F}) = (\mathbf{A}\square) \cdot \mathcal{F} + \square \cdot (\mathbf{A}\mathcal{F}) \\ \mathbf{BA}\mathcal{F} &= \square \cdot (\mathbf{A}\mathcal{F}) \end{aligned}$$

$$(\mathbf{AB} - \mathbf{BA})\mathcal{F} \cong \mathcal{F}$$

Theorem (Partial commutation)

A and **B** must satisfy:

$$\mathbf{AB} - \mathbf{BA} = 1$$

Annihilation and Creation: $AB - BA = 1$

- Can be viewed as a **rewrite rule**: $AB \mapsto 1 + BA$:



[Algebra: Polynomials/Ideal $\mathbb{C}\langle A, B \rangle / (AB - BA - 1)$.]

- Leads to **Normal form**: $\mathfrak{N}(f)$, with all **B's** before all **As**.

Lemma

The differential interpretation $A \mapsto D$, $B \mapsto X$ is faithful.

$$X \cdot f(x) := xf(x), \quad D \cdot f(x) := \frac{d}{dx}f(x).$$

$$DXf - XDf = f$$

- Agrees with classical combinatorial analysis of X , D .

$D \equiv$ “choose and delete”;

$X \equiv$ “append atom”.

1. Gates and Diagrams

~~ A first combinatorial model ~~

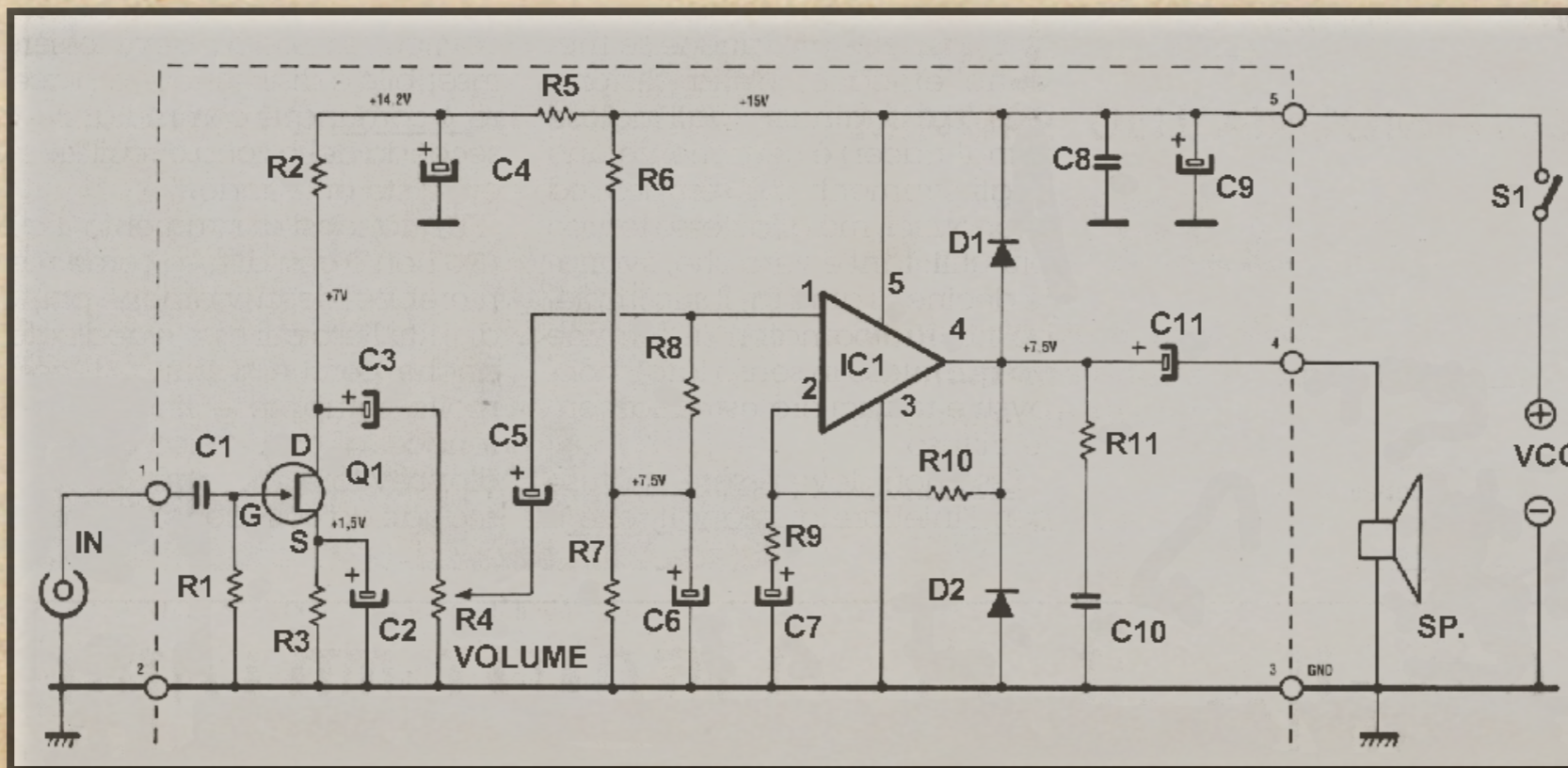

Gates and Diagrams (def.)

- A **gate** of type (r, s) is a one-vertex digraph with r incoming legs (edges) and s outgoing legs. Legs are *ordered*.
- A **diagram** is an **acyclic** assembly of gates with interconnections. A **labelled diagram** has vertices that bear integer labels.
- An **increasing diagram** is labelled and such that labels are increasing along directed paths.

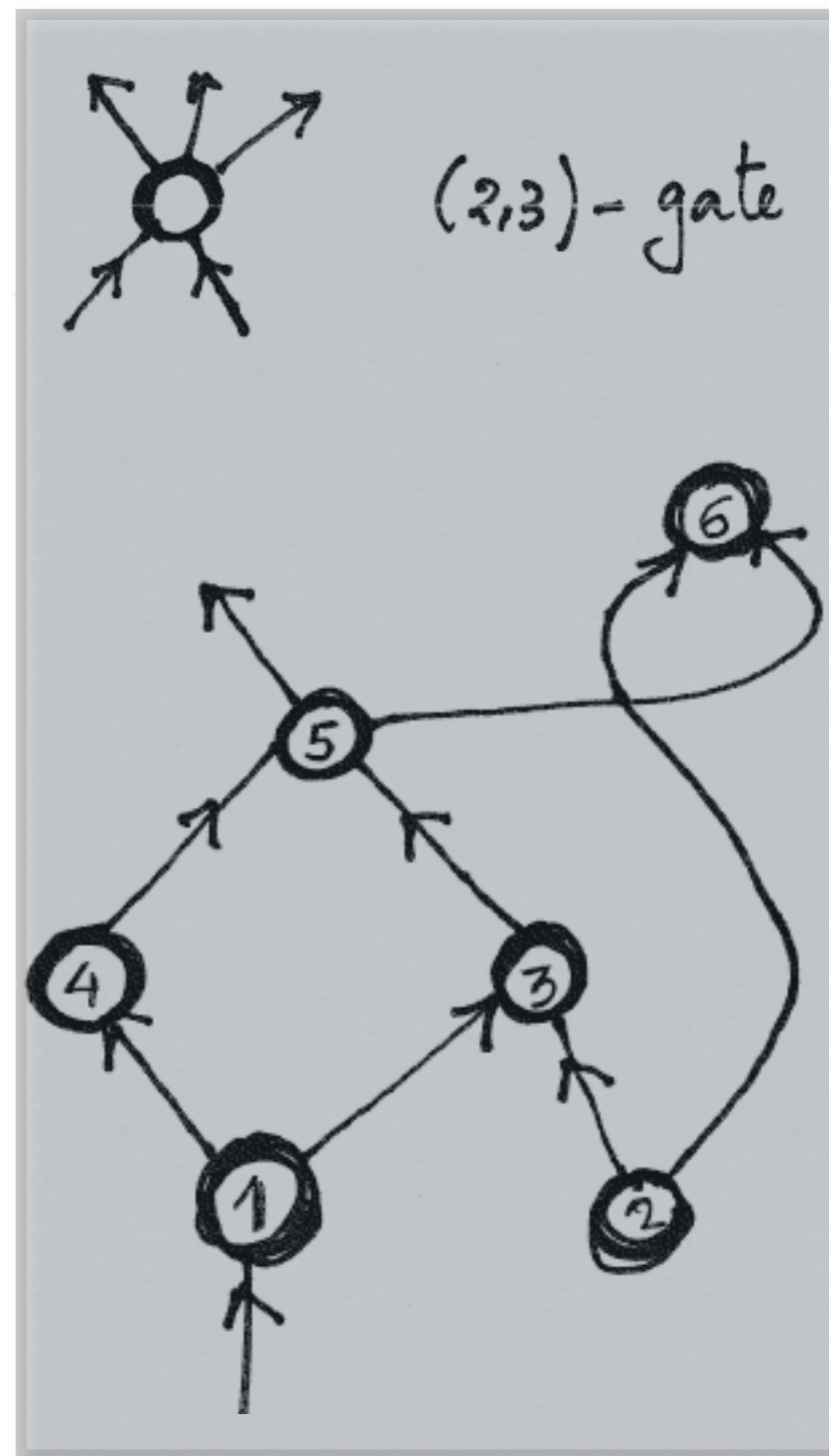

- A diagram has **basis** $\mathcal{H} \subset \mathbb{Z}_{>0} \times \mathbb{Z}_{>0}$ iff all the gates that it comprises have type in \mathcal{H} .
- Let $\mathcal{C}[\mathcal{H}]$ be the class of (increasing) **diagrams with basis \mathcal{H}** ; size is number of vertices.

Theorem (Błasiak, Penson, *et al.*, 2000++)

Consider the (normalized) operator $\mathfrak{h} = \sum_{(r,s) \in \mathcal{H}} w_{r,s} X^r D^s$. Then the **normal form of \mathfrak{h}^n** is given by

$$\mathfrak{N}(\mathfrak{h}^n) = \sum_{a,b} c_{n,a,b} X^a D^b,$$

where $c_{n,a,b} :=$

$\# \{ \text{diagrams in } \mathcal{C}[\mathcal{H}] \text{ of size } \underline{n}, \text{ with } \underline{a} \text{ inputs and } \underline{b} \text{ outputs} \}.$

Example: $(X + D)^2$

$$(X + D)^2 = XX$$

$$+ DD$$

$$+ XD$$

$$+ DX$$

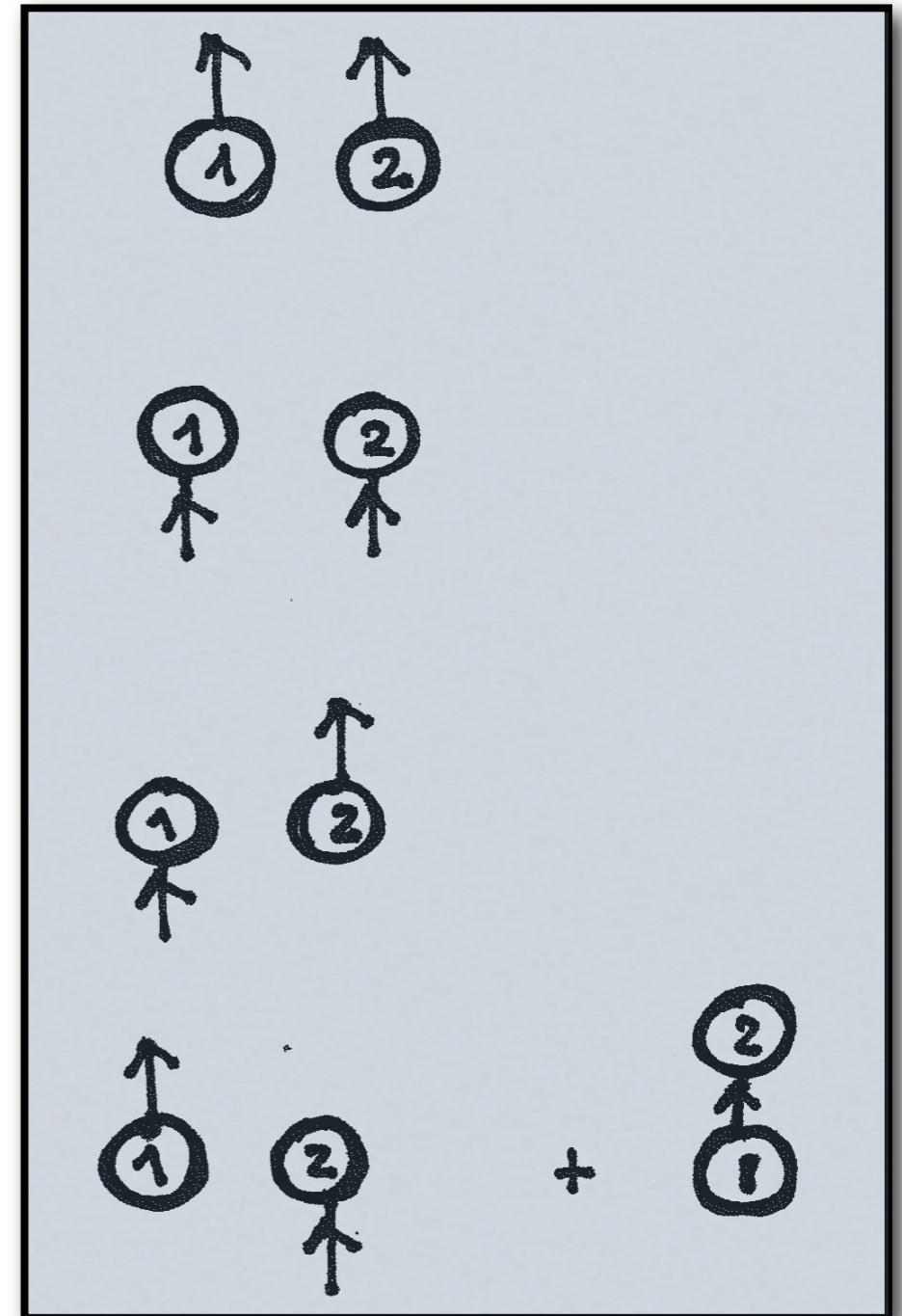

$$\mathfrak{N} [(X + D)^2] = X^2 + D^2 + 2XD + 1.$$

1, 2, 5, 14, ... ??????

Example: $(X + D)^2$

$$(X + D)^2 = XX$$

$$+ DD$$

$$+ XD$$

$$+ DX$$

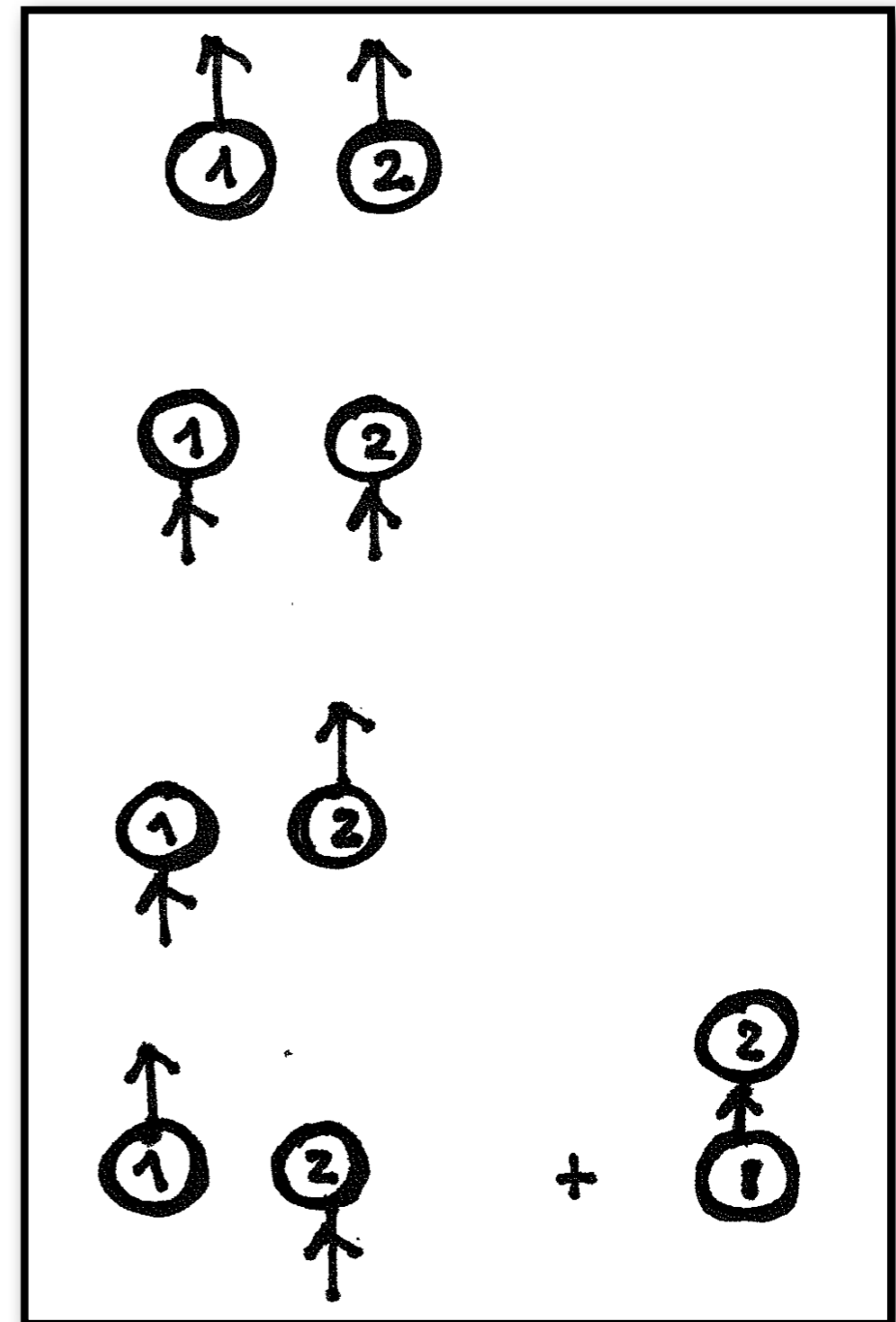

$$\mathfrak{n} [(X + D)^2] = X^2 + D^2 + 2XD + 1.$$

OEIS #5425: 1, 2, 5, 14, 43, 142, 499, 1850, ...

From algebra to combinatorics: a dictionary

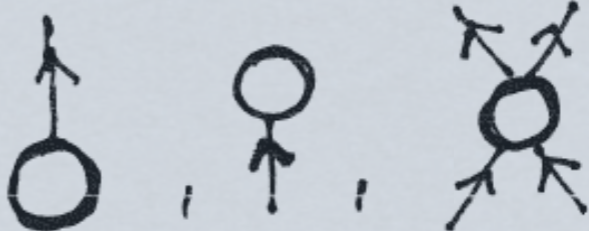
$$X + D + X^2 D^2$$

monomial $X^r D^s$	\longleftrightarrow	gate
polynomial \mathfrak{h} in X, D	\longleftrightarrow	weighted basis \mathcal{H} of gates
\mathfrak{h}^n	\longleftrightarrow	labelled diagrams of size n on \mathcal{H}
$e^{z\mathfrak{h}}$	\longleftrightarrow	generating function of all diagrams
(z, X, D)	\longleftrightarrow	(size, #outputs, #inputs).

- The exponential generating function (EGF) of all diagrams

with basis \mathcal{H} is $e^{z\mathfrak{h}}$, with $e^{z\Gamma} := \sum \Gamma^n \frac{z^n}{n!}$.

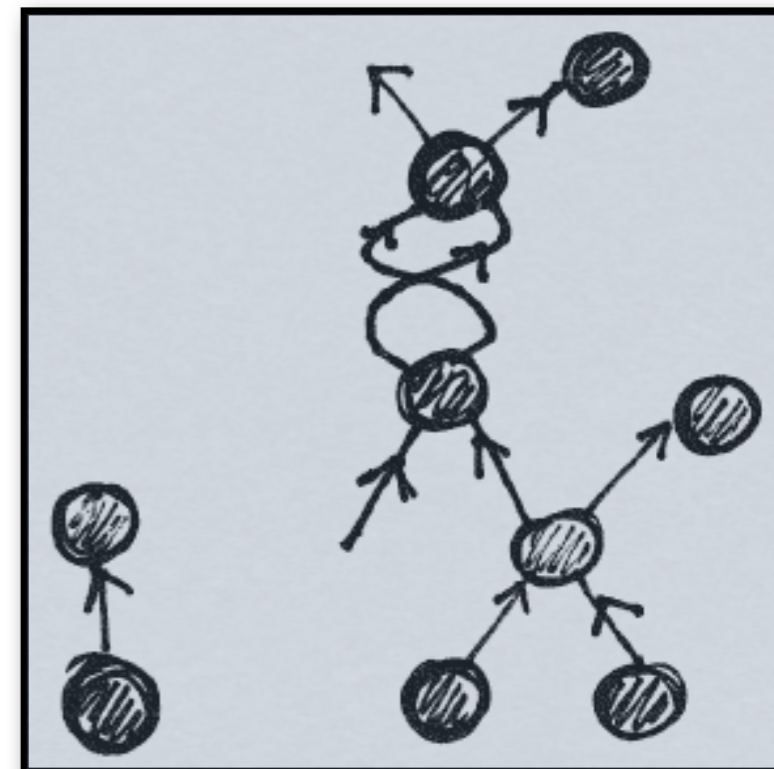



- **Conceptually(!)** for combinatorialists:
symbolic methods, theory of species, ...

D \equiv “choose and delete”; **X** \equiv “append atom”.

- Otherwise, **by recurrence** on number of gates, based on

$$(X^r D^s)(X^a D^b) = \sum_{t=0}^s \binom{s}{t} \binom{a}{t} t! X^{r+a-t} D^{s+b-t}.$$

The coefficient is also $\#$ ways of attaching a new gate to an already reduced diagram.

Cf also: Viennot-Leroux, ...

2. The $(X+D)$ forms

Involutions & such...

The form $(X + D)$ and involutions

$$\begin{array}{l}
 \mathfrak{N}[(X + D)^1] = X + D \quad \left| \quad \mathbf{2} \text{ terms (instead of 2)} \right. \\
 \mathfrak{N}[(X + D)^2] = X^2 + 2XD + D^2 + 1 \quad \left| \quad \mathbf{5} \text{ terms (instead of 4)} \right. \\
 \mathfrak{N}[(X + D)^3] = \dots 14 \text{ terms} \dots \quad \left| \quad \mathbf{14} \text{ terms (instead of 8)} \right.
 \end{array}$$

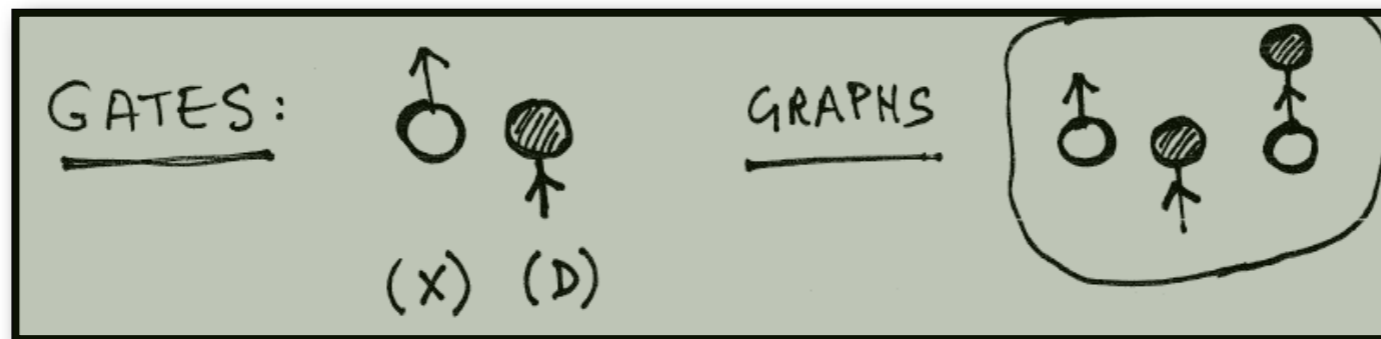

- **Involutions** ($\sigma^2 = \text{Id}$) with bicoloured singetons:

$$\exp(2z + z^2/2) = 1 + 2\frac{z}{1!} + 5\frac{z^2}{2} + 14\frac{z^3}{3!} + 43\frac{z^4}{4!} + \dots$$

- **Normal forms of $(\alpha X + \beta D)$:**

Proposition (Linear forms and involutions)

$$\mathfrak{N}((\alpha X + \beta D)^n) = \sum_{\ell, m} \frac{n!}{2^{(n-\ell-m)/2} ((n-\ell-m)/2)! \ell! m!} \alpha^{n-m} \beta^{n-\ell} X^\ell D^m.$$

Evolution equations

Definition

An equation for $F \equiv F(x, t)$, such as

$$\frac{\partial}{\partial t} F = \Gamma \cdot F, \quad F(x, 0) = f(x),$$

is known as an **evolution equation** (with initial value, or Cauchy, conditions), based on the “spatial” operator $\Gamma \in \mathbb{C} \left[x, \frac{\partial}{\partial x} \right]$.

Proposition

Evolution equation is formally solved by $F(x, t) = e^{t\Gamma} \cdot f$

Solving $\frac{\partial}{\partial t} F = \frac{\partial}{\partial x} F + xF$

- Use **normal form** $F = e^{t(X+D)} = e^{t^2/2} \cdot e^{tx} \cdot e^{tD} \cdot f$.
- **Taylor** “means” $e^{tD} \cdot f(x) = f(x + t)$.
- Conclude:

$$F(x, t) = e^{t^2/2+xt} f(x + t).$$

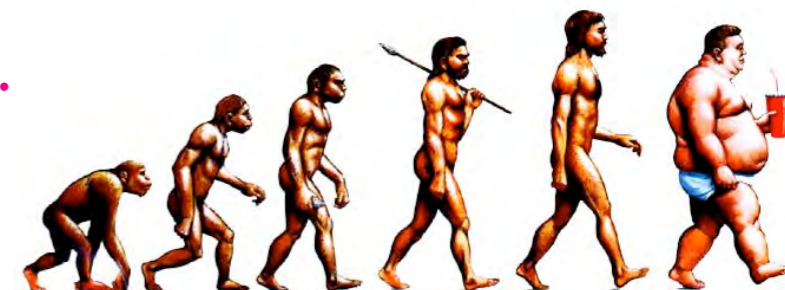

Extensions to $(X^2 + D)$, $(X + D^2)$, ...



The model is that of a **COMB**.

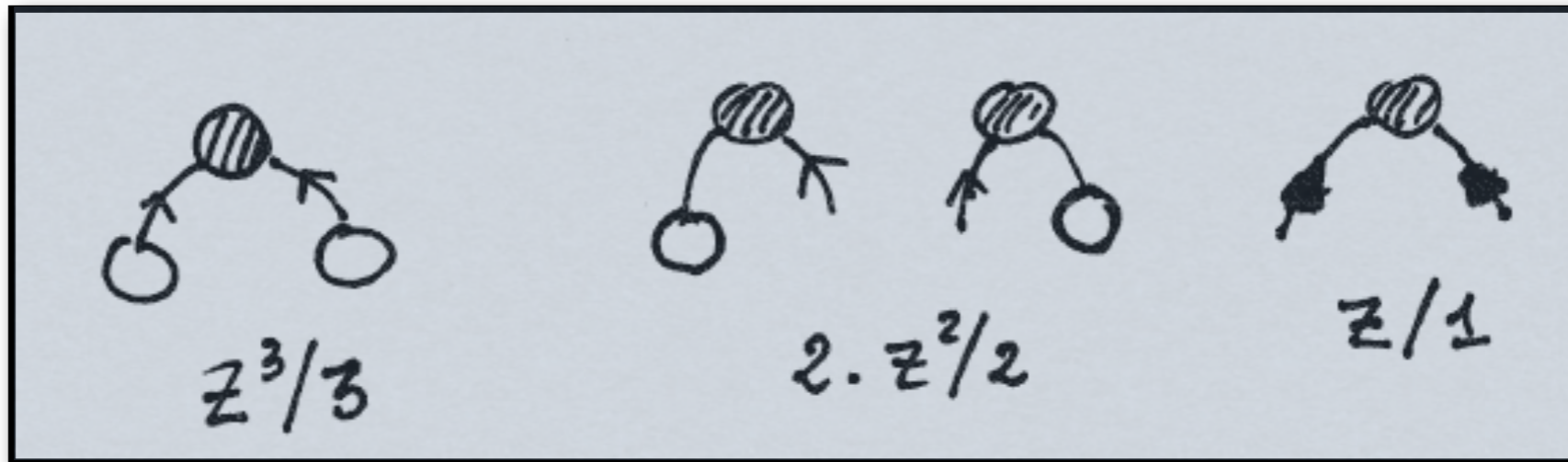

$$e^{z^3/3 + z^2 + z}$$

$$\mathfrak{N} \left[e^{z(D^2+X)} \right] = e^{z^3/3 + zX} \cdot e^{zD^2 + z^2D}.$$

- Generalization to $(a(X) + D)$ or $(a(D) + X)$;
- **PDE: solve** $\frac{\partial}{\partial t} F = \frac{\partial}{\partial x} F + a(x)F$.
[cf *method of characteristics; heat kernel...*]

3. The (XD) - forms

Set partitions & such...

The form (XD) and set partitions

- Well-known connections in analysis, difference calculus, and combinatorics(!)

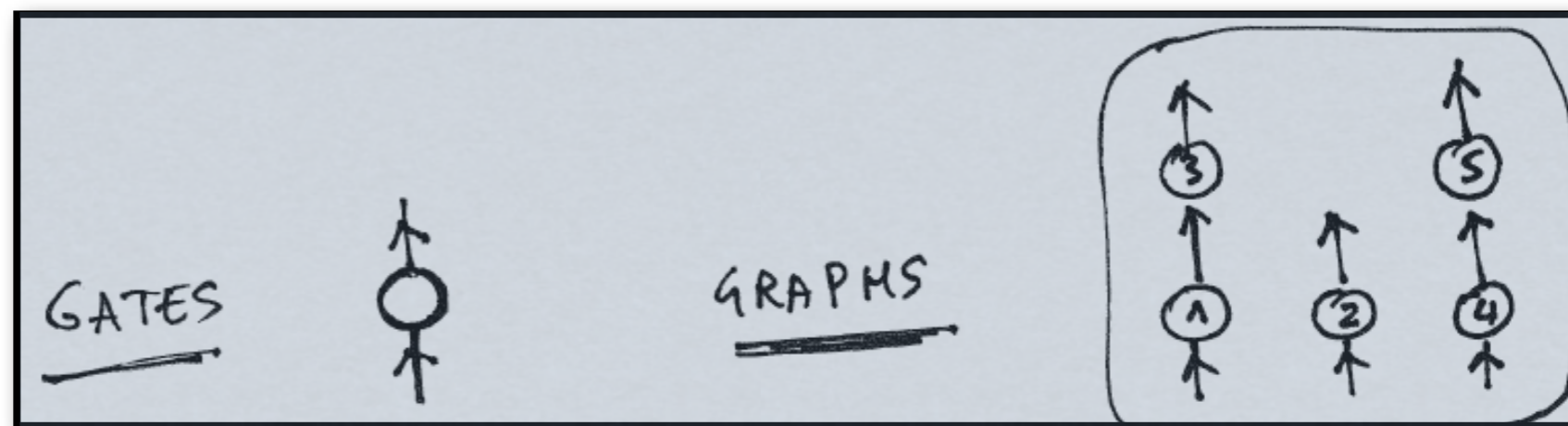

$$\mathcal{G} = \text{SET}(u \text{SET}_{\geq 1}(\mathcal{Z})) \implies G(z, u) = e^{u(e^z - 1)}.$$

$$\mathfrak{N} \left[e^{z(XD)} \right] = \sum_{k \geq 0} \frac{1}{k!} (e^z - 1)^k X^k D^k.$$

$$\rightsquigarrow \text{PDE } \frac{\partial}{\partial t} F = x \frac{\partial}{\partial x} F \text{ is solved by } F(x, t) = f(xe^t).$$

The forms (X^2D^2) and such, after Blasiak, Penson *et al.*

$$\begin{aligned} (X^2D^2) &= X^2D^2 && \mathbf{1} \\ (X^2D^2)^2 &= 2X^2D^2 + 4X^3D^3 + X^4D^4 && \mathbf{7} \quad [\text{OEIS A20556}] \\ (X^2D^2)^3 &= \dots 87 \text{ terms } \dots && \mathbf{87} \end{aligned}$$

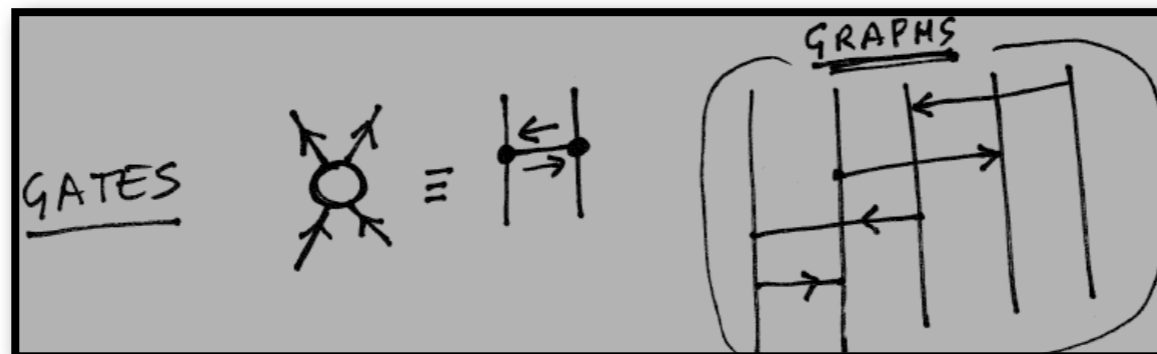

bi-labelled structures :
$$e^u G(z, x) = \sum_k (k(k-1))^n \frac{x^k}{k!} \frac{z^n}{n!}$$

$$\left\{ \begin{matrix} n \\ k \end{matrix} \right\}_{2,2} = \frac{1}{k!} \sum_j (-1)^{k-j} \binom{k}{j} (k(k-1))^n; \quad \omega_n^{(2,2)} = e^{-1} \sum_l \frac{(l(l-1))^n}{l!}.$$

- Count **matrices** with two ones per line, no null column.
- **Coupon collector** with group drawings [DuFIRoTa]:

$$\mathbb{E}_m(T) = \frac{m(m-1)}{2m-1} \left[H_m + 12m - 1 - \frac{(-1)^m}{(m+1) \binom{2m-1}{m+1}} \right] \sim \frac{1}{2} \log m.$$

- Also **set partitions** with constrained contiguities.

4. The $(X^2 + D^2)$ -form

Permutations & such

The “circle” form $(X^2 + D^2)$

- Get two types of gates: CUPS (X^2) and CAPS (D^2)



- These assemble into **chains** that are either **open** or **closed**.
- As we go along a chain, **label values alternate**.
- There are **symmetry factors** since we enter from left or right.

Alternating (zigzag) perms have EGF $\tan(z)$, $\sec(z)$ [André 1881]

Alternating cycles have EGF $\log \cos(z)$.

We must take **SETS** of these.

$$G(x, y, z) = \frac{1}{\sqrt{\cos(2z)}} \exp \left(\left(\frac{x^2}{2} + \frac{y^2}{2} \right) \tan(2z) + xy(\sec(2z) - 1) \right).$$

The general quadratic form $(\alpha X^2 + \beta D^2 + \gamma XD + \delta DX)$

Principle: similarly follow the spaghetti!

— Get the famous **peaks, troughs, double rises, double falls**.

— Cf: Carlitz; Françon–Viennot, ...

- Use **tree decomposition** of perms:

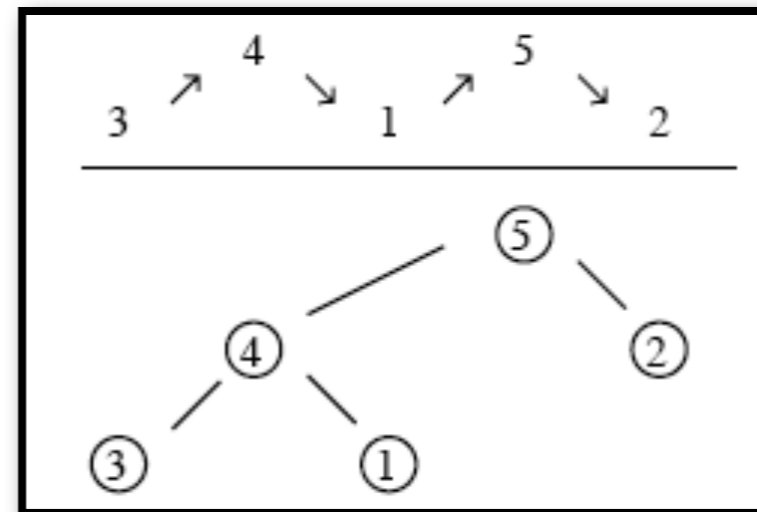

- Make use of “max-rooting $\rightsquigarrow \int$ ”.

$$A = (B^{\square} \star C) \implies A(z) = \int_0^z (\partial_t B(t)) \cdot C(t) dt$$

Contrast with Lie algebra or *ad hoc* computations.



Ordering of the exponential of a quadratic in boson operators. I. Single mode case

C. L. Mehta

5. The tree form (X^{2D})

... and trees

The special form (X^2D)

- The unique **gate is a 'Y'**.



- Get **all permutations** as **connected components**.
- Take **SETS** of these.
- GFs are variants of $\exp\left(\frac{z}{1-z}\right)$.

$$\mathfrak{N}\left[e^{zXD^2}\right] = \exp\left(z\frac{X^2}{1-zX}D\right).$$

The semilinear form $\phi(X)D$

Gives rise to **increasing trees**, with $\phi(X)$ the **basic constructor**.

- Case (XD) : threads (unary trees) \rightsquigarrow set partitions.
- Case (X^2D) : binary trees.
- Case (X^rD) : r -ary trees, ...

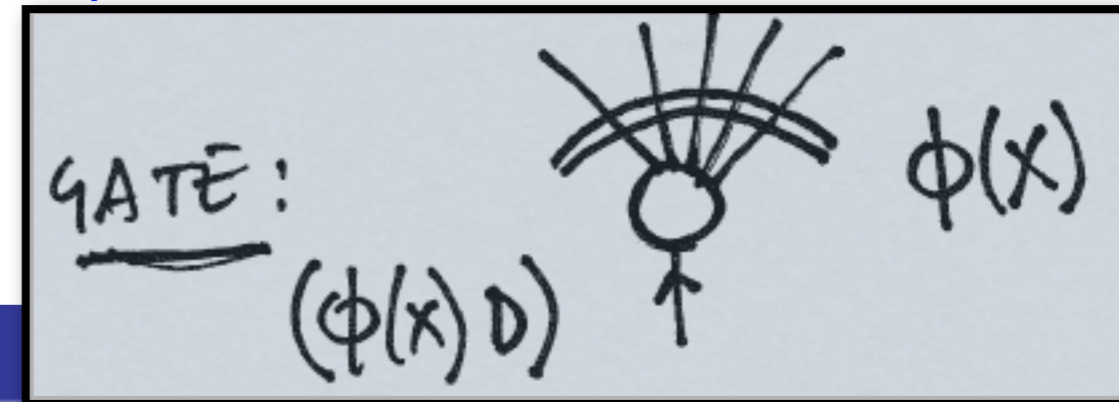

Proposition

The EGF of increasing trees with "rule" ϕ is

$$T(z) = \text{Inv} \int_0^t \frac{dw}{\phi(w)}.$$

Some exactly solvable models

[Bergeron-FI-Salvy, 1992]



Plane d -ary	$y' = (1+y)^d$	$y(z) = -1 + [1 - (d-1)z]^{-1/(d-1)}$
Plane Strict d -ary	$y' = 1 + y^d$	$d = 2 \quad y(z) = \tan z$ $d > 2 \quad -$
Non plane Strict d -ary	$y' = 1 + \frac{y^d}{d!}$	$d = 2 \quad y(z) = \sqrt{2} \tan \frac{z}{\sqrt{2}}$ $d > 2 \quad -$
Plane unary-binary	$y' = 1 + y + y^2$	$y(z) = \frac{\sqrt{3}}{2} \tan \left(\frac{\sqrt{3}}{2} z + \frac{\pi}{6} \right) - \frac{1}{2}$
Non plane unary-binary	$y' = 1 + y + y^2/2$	$y(z) = \tan \left(\frac{z}{2} + \frac{\pi}{4} \right) - 1$
Plane "Recursive"	$y' = \frac{1}{1-y}$	$y(z) = 1 - \sqrt{1-2z}$
(Non plane) "Recursive"	$y' = \exp(y)$	$y = \log \frac{1}{1-z}$

Example: XD^r , after Blasiak, Penson, Solomon

$$G(x, y, z) = \exp \left(\frac{xy}{(1 - \rho x^\rho z)^{1/\rho}} - xy \right), \quad \rho := r - 1.$$

- For $r = 3$, get $\exp \left(\frac{1}{\sqrt{1 - 2z}} - 1 \right)$, which is evocative of binary trees(?).
- Explicit binomial sums are available for \mathfrak{N} of powers of XD^r .



6. The $(X^a + D^a)$ forms

Dyck path, histories, & such

Paths and operators

In the **canonical basis** (x^k) , X and D become matrices:

$$\mathbf{D} = \begin{bmatrix} 0 & 1 & \cdot & \cdot & \cdot & \cdots \\ \cdot & 0 & 2 & \cdot & \cdot & \cdots \\ \cdot & \cdot & 0 & 3 & \cdot & \cdots \\ \cdot & \cdot & \cdot & 0 & 4 & \cdots \\ \vdots & \vdots & \vdots & \vdots & \vdots & \ddots \end{bmatrix}, \quad \mathbf{X} = \begin{bmatrix} 0 & \cdot & \cdot & \cdot & \cdot & \cdots \\ 1 & 0 & \cdot & \cdot & \cdot & \cdots \\ \cdot & 1 & 0 & \cdot & \cdot & \cdots \\ \cdot & \cdot & 1 & 0 & \cdot & \cdots \\ \vdots & \vdots & \vdots & \vdots & \vdots & \ddots \end{bmatrix}.$$

Schematically, effect on basis (x^k) is described by the “Weyl graph”:

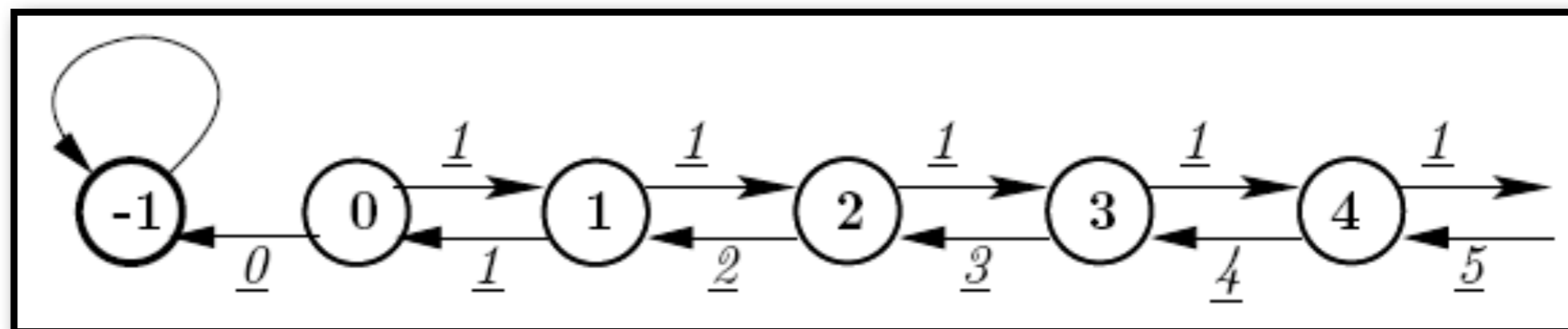

Proposition

Consider a monomial f in X, D . The constant term (of its normal form) is nonzero if and only if the associated path $\pi(f)$ in the Weyl graph, starting from vertex 0, returns to vertex 0. In that case, this constant term is equal to the multiplicative weight of the path $\pi(f)$.

Constant Terms (C.T.) = weighted Dyck paths

Theorem F-1980]

$$F(\mathbf{a}, \mathbf{d}, \ell) = \frac{1}{1 - \ell_0 - \frac{a_0 d_1}{1 - \ell_1 - \frac{a_1 d_2}{1 - \ell_2 - \frac{a_2 d_3}{\ddots}}}}$$

Dyck paths

level steps

ascents

descents

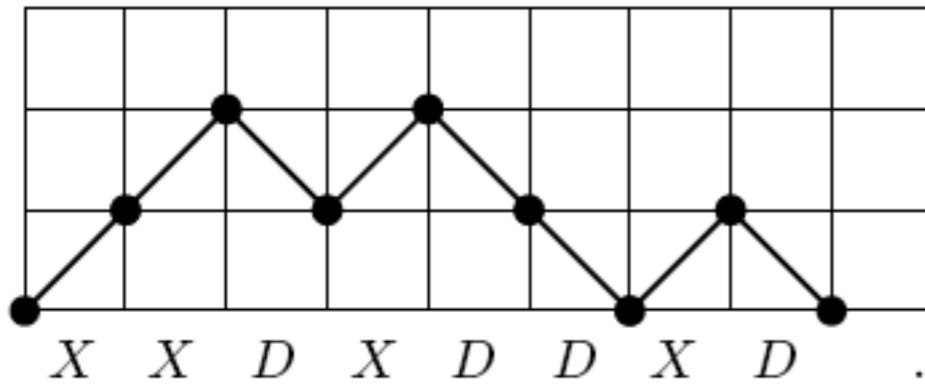

$$h = DXDDXDXX$$

$$C.T.(h) = 1 \times 1 \times 2 \times 1 \times 2 \times 1 \times 1 \times 1 = 4.$$

Proposition 2. *The normal ordering of $(X + D)$ corresponds to the continued fraction expansion*

$$C.T. \left(\frac{1}{1 - z(X + D)} \right) \equiv C.T. \left(\mathcal{L} \left[e^{z(X+D)} \right] \right) \equiv \sum_{n \geq 0} [1 \cdot 3 \cdots (2n - 1)] z^{2n} = \frac{1}{1 - \frac{1 \cdot z^2}{1 - \frac{2 \cdot z^2}{1 - \frac{3 \cdot z^2}{\ddots}}}}$$

(X+D)





Laplace transform (L)

$$(X^2 + D^2)$$

$$\mathcal{L} \left[\frac{1}{\sqrt{\cos(2z)}} \right] = \frac{1}{1 - \frac{1 \cdot 2 \cdot z^2}{1 - \frac{3 \cdot 4 \cdot z^2}{1 - \frac{5 \cdot 6 \cdot z^2}{\ddots}}}}$$

$$\Phi_3(z) = \frac{1}{1 - \frac{1 \cdot 2 \cdot 3 \cdot z^2}{1 - \frac{4 \cdot 5 \cdot 6 \cdot z^2}{1 - \frac{7 \cdot 8 \cdot 9 \cdot z^2}{\ddots}}}}$$

$$= 1 + 6z^2 + 756z^4 + 458136z^6 + 76534113z^8 + \dots$$

??

$$(X^3 + D^3)$$

Identify? Cf Dixonian elliptic functions; Apéry's $z(3)$

Openings

Partial difference equations, q-analogues,...

MISC.

- Relation with PDEs?
Eg. *Duchon's Clubs* and the *cubic oscillator*.
- *Difference equations* and q-analogues
- Relation with *Rook Polynomials* [Varvak]...
- Relation with various *tableaux*? exclusion...?
Cf Viennot, Corteel, Josuat-Verges, ...