

Subshifts in groups: From square-free words on graphs to aperiodic subshifts

Sebastián Barbieri
LIP, ENS de Lyon

Séminaire Combinatoire et Algorithmes de Rouen
October, 2015

Subshifts in \mathbb{Z}

\mathbb{Z} -Subshifts

- ▶ \mathcal{A} is a finite alphabet. Ex : $\mathcal{A} = \{0, 1\}$.
- ▶ $\mathcal{A}^{\mathbb{Z}}$ is the set of functions from \mathbb{Z} to \mathcal{A}
- ▶ $\sigma : \mathbb{Z} \times \mathcal{A}^{\mathbb{Z}} \rightarrow \mathcal{A}^{\mathbb{Z}}$ is the shift action given by :

$$\sigma_k(x)_i = x_{i+k}.$$

\mathbb{Z} -Subshifts

- ▶ \mathcal{A} is a finite alphabet. Ex : $\mathcal{A} = \{0, 1\}$.
- ▶ $\mathcal{A}^{\mathbb{Z}}$ is the set of functions from \mathbb{Z} to \mathcal{A}
- ▶ $\sigma : \mathbb{Z} \times \mathcal{A}^{\mathbb{Z}} \rightarrow \mathcal{A}^{\mathbb{Z}}$ is the shift action given by :

$$\sigma_k(x)_i = x_{i+k}.$$

Definition : \mathbb{Z} -subshift

$X \subset \mathcal{A}^{\mathbb{Z}}$ is a \mathbb{Z} -subshift if and only if it is invariant under the action of σ and closed for the product topology on $\mathcal{A}^{\mathbb{Z}}$.

\mathbb{Z} -Subshifts

- ▶ \mathcal{A} is a finite alphabet. Ex : $\mathcal{A} = \{0, 1\}$.
- ▶ $\mathcal{A}^{\mathbb{Z}}$ is the set of functions from \mathbb{Z} to \mathcal{A}
- ▶ $\sigma : \mathbb{Z} \times \mathcal{A}^{\mathbb{Z}} \rightarrow \mathcal{A}^{\mathbb{Z}}$ is the shift action given by :

$$\sigma_k(x)_i = x_{i+k}.$$

Definition : \mathbb{Z} -subshift

$X \subset \mathcal{A}^{\mathbb{Z}}$ is a \mathbb{Z} -subshift if and only if it is invariant under the action of σ and closed for the product topology on $\mathcal{A}^{\mathbb{Z}}$.

Alternative definition : \mathbb{Z} -subshift

X is a \mathbb{Z} -subshift if and only if it can be defined as the set of bi-infinite words which avoid a set forbidden words : $\exists \mathcal{F} \subset \mathcal{A}^*$ such that :

$$X = X_{\mathcal{F}} := \{x \in \mathcal{A}^{\mathbb{Z}} \mid \forall w \in \mathcal{F} : w \not\subset x\}.$$

\mathbb{Z} -Subshift examples

Example : full shift. Let $\mathcal{A} = \{0, 1\}$ and $\mathcal{F} = \emptyset$. Then $X_{\mathcal{F}} = \mathcal{A}^{\mathbb{Z}}$ is the set of all bi-infinite words.

\mathbb{Z} -Subshift examples

Example : full shift. Let $\mathcal{A} = \{0, 1\}$ and $\mathcal{F} = \emptyset$. Then $X_{\mathcal{F}} = \mathcal{A}^{\mathbb{Z}}$ is the set of all bi-infinite words.

Example : Fibonacci shift. Let $\mathcal{A} = \{0, 1\}$ and $\mathcal{F} = \{11\}$. Then X_{Fib} is the set of all bi-infinite words which have no pairs of consecutive 1's.

$$x = \dots 010100010100100100100 \dots \in X_{Fib}$$

\mathbb{Z} -Subshift examples

Example : full shift. Let $\mathcal{A} = \{0, 1\}$ and $\mathcal{F} = \emptyset$. Then $X_{\mathcal{F}} = \mathcal{A}^{\mathbb{Z}}$ is the set of all bi-infinite words.

Example : Fibonacci shift. Let $\mathcal{A} = \{0, 1\}$ and $\mathcal{F} = \{11\}$. Then X_{Fib} is the set of all bi-infinite words which have no pairs of consecutive 1's.

$$x = \dots 010100010100100100100 \dots \in X_{Fib}$$

Consider the Thue-Morse morphism $0 \rightarrow 01$ and $1 \rightarrow 10$.

$$0 \rightarrow 01 \rightarrow 0110 \rightarrow 01101001 \rightarrow 0110100110010110 \rightarrow \dots$$

\mathbb{Z} -Subshift examples

Example : full shift. Let $\mathcal{A} = \{0, 1\}$ and $\mathcal{F} = \emptyset$. Then $X_{\mathcal{F}} = \mathcal{A}^{\mathbb{Z}}$ is the set of all bi-infinite words.

Example : Fibonacci shift. Let $\mathcal{A} = \{0, 1\}$ and $\mathcal{F} = \{11\}$. Then X_{Fib} is the set of all bi-infinite words which have no pairs of consecutive 1's.

$$x = \dots 010100010100100100100 \dots \in X_{Fib}$$

Example : Thue-Morse subshift Consider the morphism $0 \rightarrow 01$ and $1 \rightarrow 10$. The Thue-Morse subshift X_{TM} is the set of bi-infinite sequences such that every subword appears as a substring in some iteration of the morphism.

$$x = \dots 101001100101101001011001101001 \dots \in X_{TM}$$

Periodicity

Definition : periodic point

We say $x \in X$ is periodic if there exists $z \in \mathbb{Z} \setminus \{0\}$ such that :

$$\sigma_z(x) = x$$

Definition : periodic point

We say $x \in X$ is periodic if there exists $z \in \mathbb{Z} \setminus \{0\}$ such that :

$$\sigma_z(x) = x$$

Example : period 4

$$x = \dots 1110111011101110111011101 \dots = (0111)^\infty$$

Definition : periodic point

We say $x \in X$ is periodic if there exists $z \in \mathbb{Z} \setminus \{0\}$ such that :

$$\sigma_z(x) = x$$

Example : period 4

$$x = \dots 1110111011101110111011101 \dots = (0111)^\infty$$

Definition : aperiodic \mathbb{Z} -subshift

We say $X \subset \mathcal{A}^{\mathbb{Z}}$ is aperiodic if for every configuration $x \in X$ then x is not periodic.

Periodicity examples

Example : full shift. The full-shift over $\{0, 1\}$ cannot be aperiodic, it contains for example the constant configuration 0^∞ .

Periodicity examples

Example : full shift. The full-shift over $\{0, 1\}$ cannot be aperiodic, it contains for example the constant configuration 0^∞ .

Example : Fibonacci shift. The Fibonacci shift is also not aperiodic, it contains for example :

$$x = \dots 01010101010101 \dots = (01)^\infty \in X_{\mathcal{F}}$$

Periodicity examples

Example : full shift. The full-shift over $\{0, 1\}$ cannot be aperiodic, it contains for example the constant configuration 0^∞ .

Example : Fibonacci shift. The Fibonacci shift is also not aperiodic, it contains for example :

$$x = \dots 01010101010101 \dots = (01)^\infty \in X_{\mathcal{F}}$$

Example : Thue-Morse subshift The Thue-Morse subshift is indeed aperiodic !

Aperiodicity of the Thue-Morse subshift

Recall the Thue-Morse morphism that acts by $0 \rightarrow 01$ and $1 \rightarrow 10$.

$0 \rightarrow 01 \rightarrow 0110 \rightarrow 01101001 \rightarrow 0110100110010110 \rightarrow \dots$

Aperiodicity of the Thue-Morse subshift

Recall the Thue-Morse morphism that acts by $0 \rightarrow 01$ and $1 \rightarrow 10$.

$0 \rightarrow 01 \rightarrow 0110 \rightarrow 01101001 \rightarrow 0110100110010110 \rightarrow \dots$

Property :

The Thue-Morse sequence is cube-free.

Aperiodicity of the Thue-Morse subshift

Recall the Thue-Morse morphism that acts by $0 \rightarrow 01$ and $1 \rightarrow 10$.

$0 \rightarrow 01 \rightarrow 0110 \rightarrow 01101001 \rightarrow 0110100110010110 \rightarrow \dots$

Property :

The Thue-Morse sequence is cube-free.

Suppose there is $x \in X_{\text{TM}}$ and $z \in \mathbb{Z} \setminus \{0\}$ such that $\sigma_z(x) = x$. Then $x|_{\{1,2,\dots,3|z|\}}$ is a cube-word, therefore not contained in any iteration of the morphism. This yields a contradiction.

Subshifts of finite type.

- ▶ What about if we only consider local rules?

Definition : subshift of finite type.

A \mathbb{Z} -subshift is of finite type (SFT) if it can be defined by a finite set \mathcal{F} of forbidden words.

Example : Both the full-shift and the Fibonacci shift are of finite type.

Subshifts of finite type.

- ▶ What about if we only consider local rules?

Definition : subshift of finite type.

A \mathbb{Z} -subshift is of finite type (SFT) if it can be defined by a finite set \mathcal{F} of forbidden words.

Example : Both the full-shift and the Fibonacci shift are of finite type.

- ▶ What can we say about periodicity? Is the Thue-Morse subshift of finite type?

Subshifts of finite type.

Theorem :

The set of configurations of a \mathbb{Z} -SFT can be characterized as the set of bi-infinite walks in a finite graph.

Subshifts of finite type.

Theorem :

The set of configurations of a \mathbb{Z} -SFT can be characterized as the set of bi-infinite walks in a finite graph.

Example : Consider the Fibonacci shift given by $\mathcal{F} = \{11\}$.

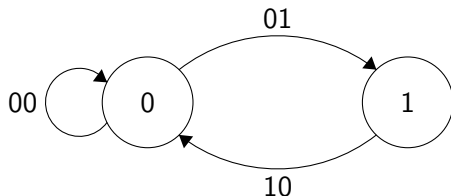

Subshifts of finite type.

Theorem :

The set of configurations of a \mathbb{Z} -SFT can be characterized as the set of bi-infinite walks in a finite graph.

Example : Consider the Fibonacci shift given by $\mathcal{F} = \{11\}$.

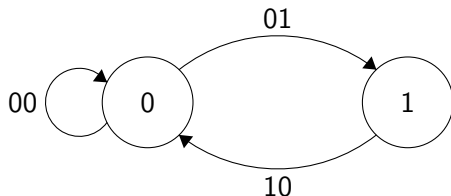

As the graph is finite, an SFT X is non-empty if and only if the graph contains a cycle, thus every \mathbb{Z} -SFT contains periodic configurations!

Therefore, the Thue-Morse subshift is not of finite type.

Subshifts in \mathbb{Z}^2

\mathbb{Z}^2 -Subshifts

Now configurations are on the plane.

- ▶ $\mathcal{A}^{\mathbb{Z}^2}$ is the set of functions from \mathbb{Z}^2 to \mathcal{A}
- ▶ $\sigma : \mathbb{Z}^2 \times \mathcal{A}^{\mathbb{Z}^2} \rightarrow \mathcal{A}^{\mathbb{Z}^2}$ is the shift action given by :

$$\sigma_k(x)_i = x_{i+k}.$$

Now configurations are on the plane.

- ▶ $\mathcal{A}^{\mathbb{Z}^2}$ is the set of functions from \mathbb{Z}^2 to \mathcal{A}
- ▶ $\sigma : \mathbb{Z}^2 \times \mathcal{A}^{\mathbb{Z}^2} \rightarrow \mathcal{A}^{\mathbb{Z}^2}$ is the shift action given by :

$$\sigma_k(x)_i = x_{i+k}.$$

Instead of a set of forbidden words, we have a set of forbidden patterns. In the same way as in \mathbb{Z} , a \mathbb{Z}^2 -subshift is of finite type if it is defined by a finite set of forbidden patterns.

Now configurations are on the plane.

- ▶ $\mathcal{A}^{\mathbb{Z}^2}$ is the set of functions from \mathbb{Z}^2 to \mathcal{A}
- ▶ $\sigma : \mathbb{Z}^2 \times \mathcal{A}^{\mathbb{Z}^2} \rightarrow \mathcal{A}^{\mathbb{Z}^2}$ is the shift action given by :

$$\sigma_k(x)_i = x_{i+k}.$$

Instead of a set of forbidden words, we have a set of forbidden patterns. In the same way as in \mathbb{Z} , a \mathbb{Z}^2 -subshift is of finite type if it is defined by a finite set of forbidden patterns.

Are there any aperiodic \mathbb{Z}^2 -SFTs?

Example in \mathbb{Z}^2 : Fibonacci shift

Example : Fibonacci shift. X_{Fib} is the set of assignments of \mathbb{Z}^2 to $\{0, 1\}$ such that there are no two adjacent ones.

Example in \mathbb{Z}^2 : Fibonacci shift

Example : Fibonacci shift. X_{Fib} is the set of assignments of \mathbb{Z}^2 to $\{0, 1\}$ such that there are no two adjacent ones.

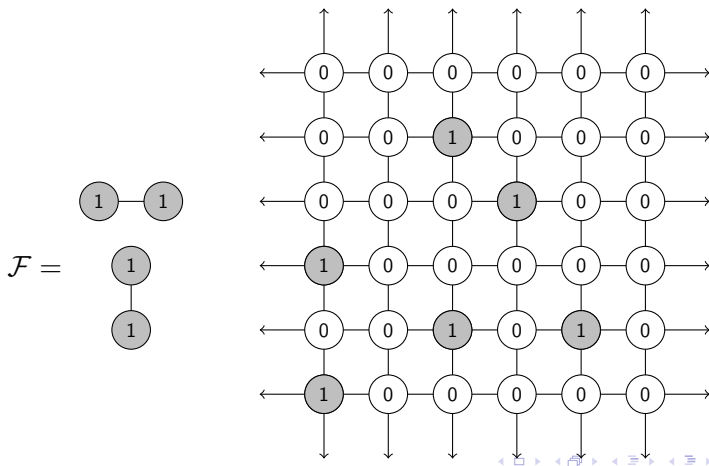

Wang's conjecture

Wang's conjecture

There are no non-empty aperiodic \mathbb{Z}^2 -SFT.

Note : Wang actually formulated an equivalent version using square colored tiles (Wang tiles)

Wang's conjecture

Wang's conjecture

There are no non-empty aperiodic \mathbb{Z}^2 -SFT.

Note : Wang actually formulated an equivalent version using square colored tiles (Wang tiles)

Theorem[Berger 1966]

Wang's conjecture is FALSE

Wang's conjecture

Wang's conjecture

There are no non-empty aperiodic \mathbb{Z}^2 -SFT.

Note : Wang actually formulated an equivalent version using square colored tiles (Wang tiles)

Theorem[Berger 1966]

Wang's conjecture is FALSE

His construction encodes a Turing machine using an alphabet of size 20426.

His proof was later simplified by Robinson[1971].

Robinson tileset

The Robinson tileset, where tiles can be rotated.

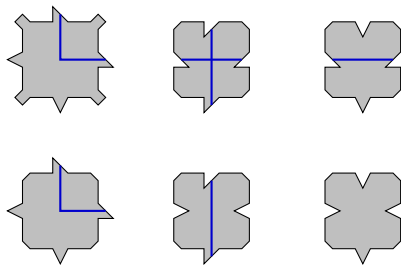

Existence of a valid tiling

Proposition

Robinson's tileset admits at least one valid tiling.

Macro-tiles of level 1.

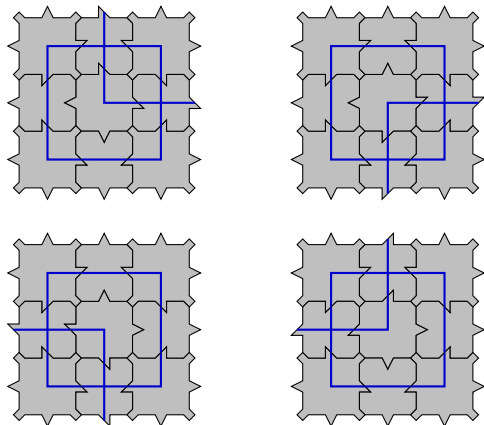

Existence of a valid tiling

Proposition

Robinson's tileset admits at least one valid tiling.

Macro-tiles of level 1.

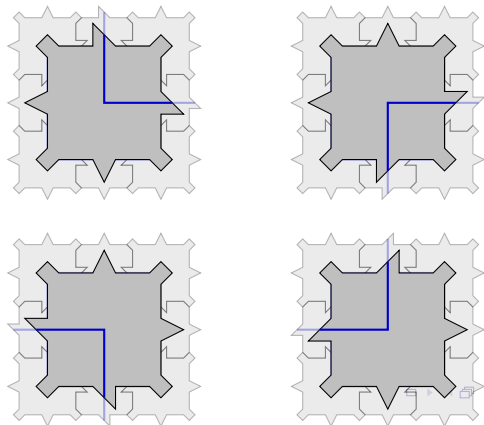

From macro-tiles of level 1 to macro-tiles of level 2

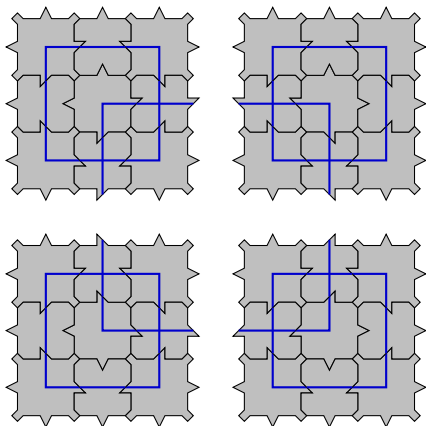

From macro-tiles of level 1 to macro-tiles of level 2

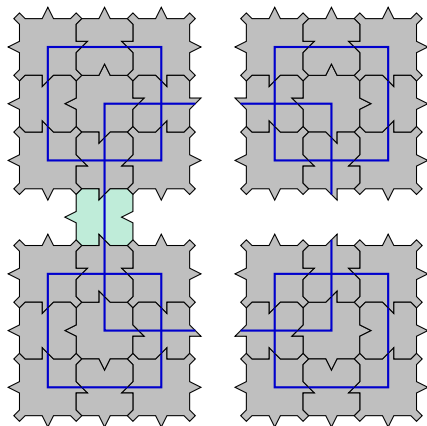

From macro-tiles of level 1 to macro-tiles of level 2

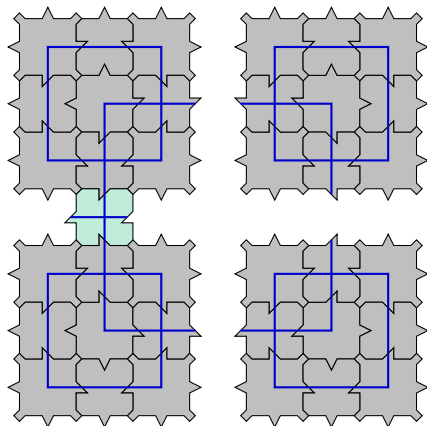

From macro-tiles of level 1 to macro-tiles of level 2

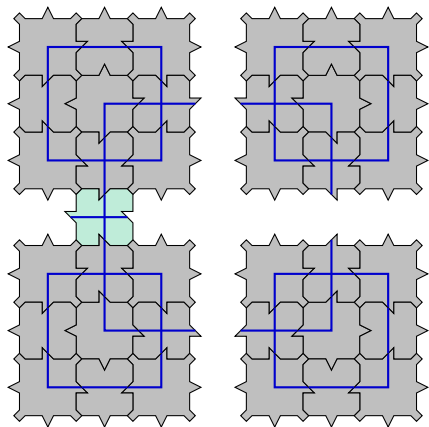

From macro-tiles of level 1 to macro-tiles of level 2

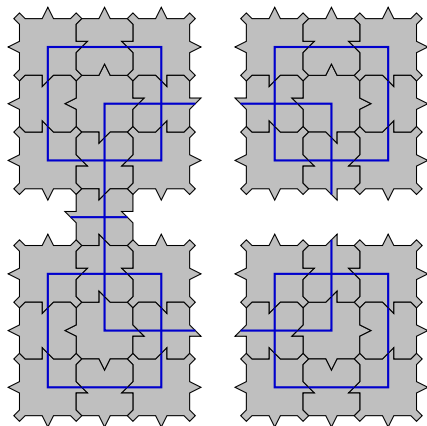

From macro-tiles of level 1 to macro-tiles of level 2

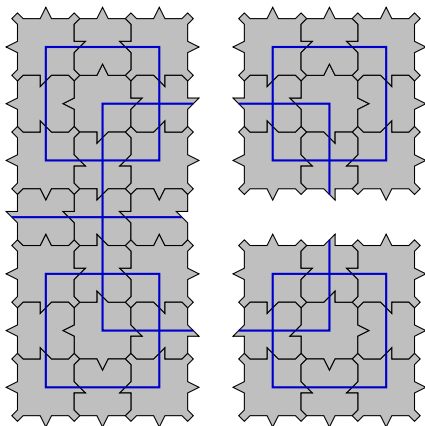

From macro-tiles of level 1 to macro-tiles of level 2

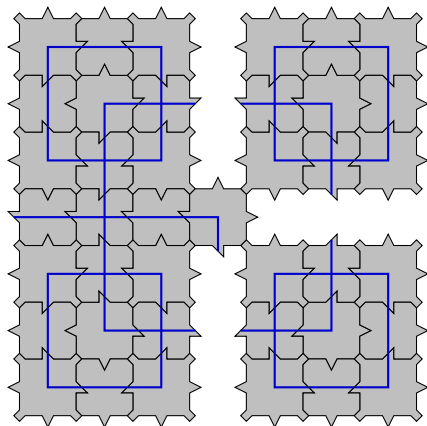

From macro-tiles of level 1 to macro-tiles of level 2

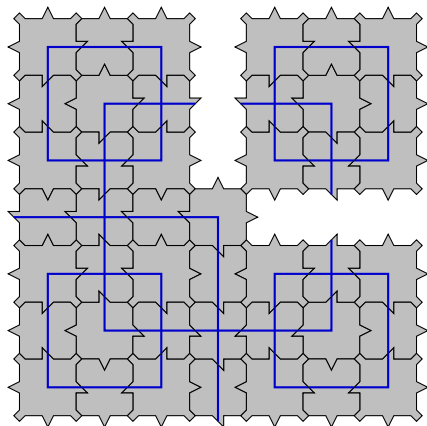

From macro-tiles of level 1 to macro-tiles of level 2

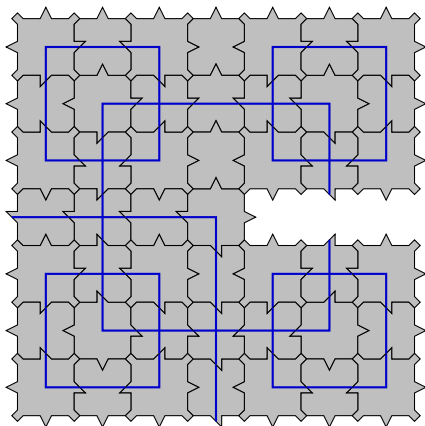

From macro-tiles of level 1 to macro-tiles of level 2

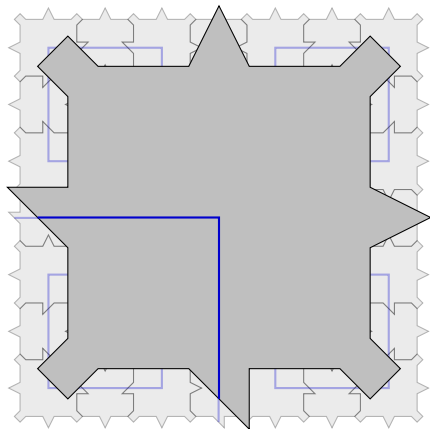

From macro-tiles of level n to macro-tiles of level $n + 1$

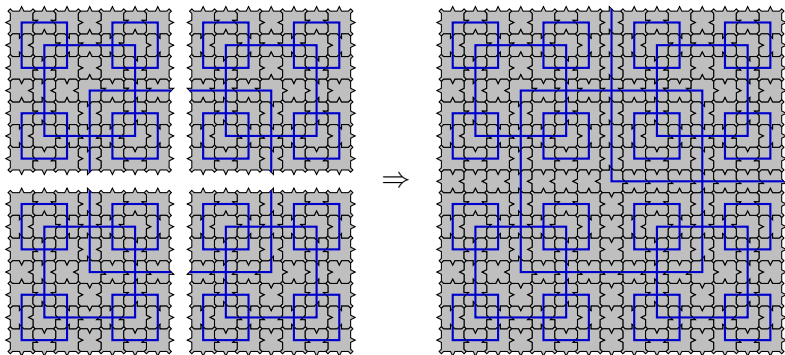

One can thus construct a valid tiling by a compactness argument.

This valid tiling is aperiodic

Proposition

The valid tiling x obtained by compactness is aperiodic.

Proof :

- Centers of macro-tiles of level n are located a $2^{n+1}\mathbb{Z} \times 2^{n+1}\mathbb{Z}$ -lattice.
- Suppose x admits a direction of periodicity \vec{u} .
- Then there exists an integer n s.t. $2^{n+1} > \|\vec{u}\|$.
- Thus a macro-tile of level n overlaps with its translation.
- \Rightarrow contradiction.

All valid tilings are aperiodic (I)

The two forms in Robinson tileset, cross (bumpy corners) and arms (dented corners).

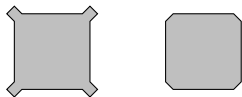

All valid tilings are aperiodic (I)

The two forms in Robinson tileset, cross (bumpy corners) and arms (dented corners).

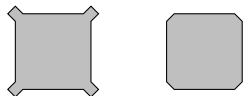

Obviously, two crosses cannot be in contact (neither through an edge nor a vertex) hence a cross must be surrounded by eight arms.

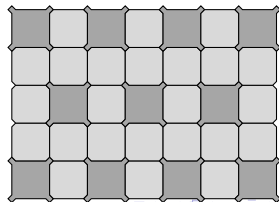
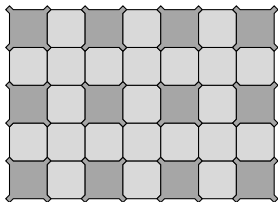

All valid tilings are aperiodic (II)

You cannot have things like

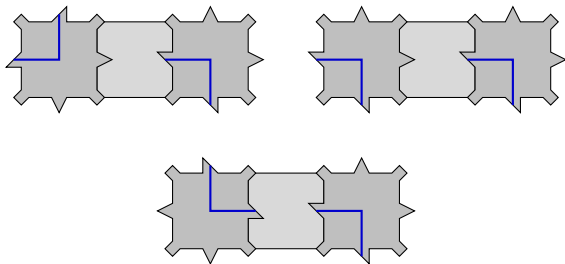

All valid tilings are aperiodic (II)

You cannot have things like

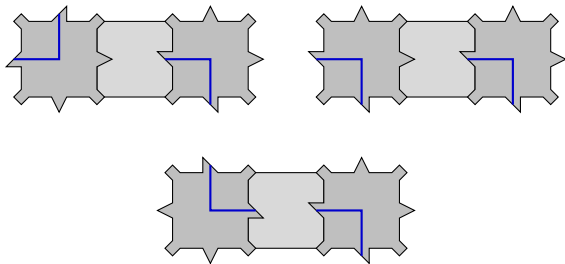

The only possibilities are

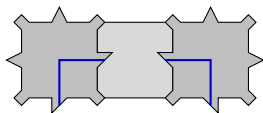

All valid tilings are aperiodic (II)

You cannot have things like

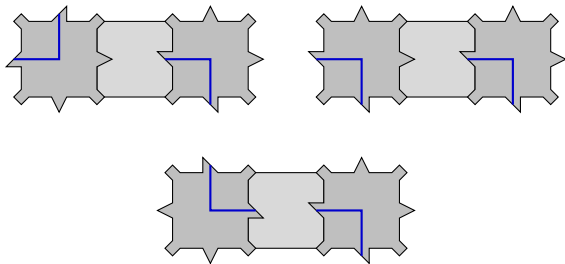

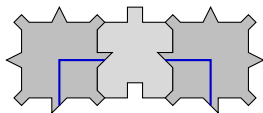

The only possibilities are

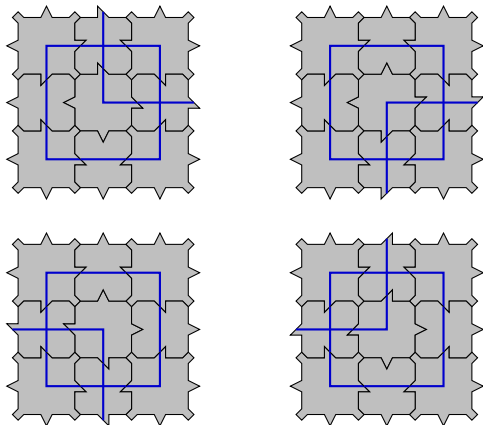

All valid tilings are aperiodic (III)

So each  is part of a macro tile of level 1



that behaves like a big , and so on...

Aperiodicity of the Robinson tiling

Therefore, any configuration in the Robinson tiling contains arbitrary level macro-tiles and the previous argument shows they cannot have any periodic behavior.

Aperiodicity of the Robinson tiling

Therefore, any configuration in the Robinson tiling contains arbitrary level macro-tiles and the previous argument shows they cannot have any periodic behavior.

Therefore, there exist non-empty aperiodic \mathbb{Z}^2 -SFTs.

Aperiodicity of the Robinson tiling

Therefore, any configuration in the Robinson tiling contains arbitrary level macro-tiles and the previous argument shows they cannot have any periodic behavior.

Therefore, there exist non-empty aperiodic \mathbb{Z}^2 -SFTs.

So far, we have shown...

- ▶ \mathbb{Z} -SFTs are never aperiodic.
- ▶ There exist aperiodic \mathbb{Z}^2 -SFTs. (1966 Berger, 1971 Robinson, 1996 Kari)

Subshifts in finitely generated groups

Finitely generated groups

Now configurations are on a group G .

- ▶ \mathcal{A}^G is the set of functions from G to \mathcal{A}
- ▶ $\sigma : G \times \mathcal{A}^G \rightarrow \mathcal{A}^G$ is the shift action given by :

$$\sigma_g(x)_h = x_{g^{-1}h}.$$

- G -subshifts are defined analogously.

Finitely generated groups

Now configurations are on a group G .

- ▶ \mathcal{A}^G is the set of functions from G to \mathcal{A}
- ▶ $\sigma : G \times \mathcal{A}^G \rightarrow \mathcal{A}^G$ is the shift action given by :

$$\sigma_g(x)_h = x_{g^{-1}h}.$$

- G -subshifts are defined analogously.

Are there any aperiodic G -SFTs?

Finitely generated groups

Now configurations are on a group G .

- ▶ \mathcal{A}^G is the set of functions from G to \mathcal{A}
- ▶ $\sigma : G \times \mathcal{A}^G \rightarrow \mathcal{A}^G$ is the shift action given by :

$$\sigma_g(x)_h = x_{g^{-1}h}.$$

- G -subshifts are defined analogously.

Are there any aperiodic G -SFTs?

There is no general characterization of which groups admit aperiodic SFTs.

Some recent partial results

- ▶ There are weakly aperiodic SFTs in Baumslag Solitar groups (2013 Aubrun-Kari)
- ▶ There are aperiodic SFTs in the Heisenberg group (2014 Sahin-Schraudner)
- ▶ The existence of an aperiodic SFT in G implies that G is one ended (2014 Cohen)
- ▶ The existence of an aperiodic SFT is a quasi-isometry invariant for finitely presented torsion-free groups. (2014 Cohen)
- ▶ A recursively presented group which admits an aperiodic SFT has decidable word problem (2015 Jeandel)

Some recent partial results

It is even hard to come up with examples of aperiodic subshifts in general groups if we retreat the finite type property of the list of forbidden patterns.

Question by Glasner and Uspenskij 2009

Is there any countable group which does not admit any aperiodic subshift on a two symbol alphabet?

Some recent partial results

It is even hard to come up with examples of aperiodic subshifts in general groups if we retreat the finite type property of the list of forbidden patterns.

Question by Glasner and Uspenskij 2009

Is there any countable group which does not admit any aperiodic subshift on a two symbol alphabet?

Theorem by Gao, Jackson and Seward 2009

No. All do.

And the proof is a quite technical construction.

However...

However! It is possible to show the same result by using tools from probabilities and combinatorics.

However...

However! It is possible to show the same result by using tools from probabilities and combinatorics.

Theorem by Aubrun, B, Thomassé

No. All do.

But now the proof is short. It uses the asymmetrical version of Lovász Local Lemma.

However...

However! It is possible to show the same result by using tools from probabilities and combinatorics.

Theorem by Aubrun, B, Thomassé

No. All do.

But now the proof is short. It uses the asymmetrical version of Lovász Local Lemma.

We will present here a slightly different version which uses a generalization of square free words. It will only work for finitely generated groups and it will use a larger alphabet.

Lovász Local Lemma

Lovász Local Lemma (Asymmetrical version)

Let $\mathcal{A} := \{A_1, A_2, \dots, A_n\}$ be a finite collection of measurable sets in a probability space $(X, \mathbb{P}, \mathcal{B})$. For $A \in \mathcal{A}$, let $\Gamma(A)$ be the subset of \mathcal{A} such that A is independent of the collection $\mathcal{A} \setminus (\{A\} \cup \Gamma(A))$. Suppose there exists a function $x : \mathcal{A} \rightarrow (0, 1)$ such that :

$$\forall A \in \mathcal{A} : \mathbb{P}(A) \leq x(A) \prod_{B \in \Gamma(A)} (1 - x(B))$$

then the probability of avoiding all events in \mathcal{A} is positive, in particular :

$$\mathbb{P} \left(X \setminus \bigcup_{i=1}^n A_i \right) \geq \prod_{A \in \mathcal{A}} (1 - x(A)) > 0.$$

Back to Thue-Morse

Recall the Thue-Morse morphism $0 \rightarrow 01$ and $1 \rightarrow 10$.

$0 \rightarrow 01 \rightarrow 0110 \rightarrow 01101001 \rightarrow 0110100110010110 \rightarrow \dots$

Back to Thue-Morse

Recall the Thue-Morse morphism $0 \rightarrow 01$ and $1 \rightarrow 10$.

$$0 \rightarrow 01 \rightarrow 0110 \rightarrow 01101001 \rightarrow 0110100110010110 \rightarrow \dots$$

It is not hard to modify it so that it avoids squares.

$$0 \rightarrow 01210$$
$$1 \rightarrow 12021$$
$$2 \rightarrow 20102$$
$$0 \rightarrow 01210 \rightarrow 0121012021201021202101210\dots$$

We can interpret this sequence of words as colorings without squares over a path graph.

Square-free vertex coloring

Square-free vertex coloring

Let $G = (V, E)$ be a graph. A vertex coloring is a function $x : V \rightarrow \mathcal{A}$. We say it is square-free if for every odd-length path $p = v_1 \dots v_{2n}$ then there exists $1 \leq j \leq n$ such that $x(v_j) \neq x(v_{j+n})$.

Square-free vertex coloring

Square-free vertex coloring

Let $G = (V, E)$ be a graph. A vertex coloring is a function $x : V \rightarrow \mathcal{A}$. We say it is square-free if for every odd-length path $p = v_1 \dots v_{2n}$ then there exists $1 \leq j \leq n$ such that $x(v_j) \neq x(v_{j+n})$.

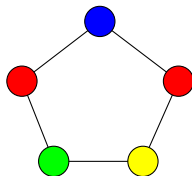
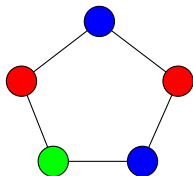

C_5 has a square-free vertex coloring with 4 colors, but not with 3.

Square-free vertex coloring

For our purposes, we are interested in coloring infinite graphs. This can not always be done with a finite number of colors : $K_{\mathbb{N}}$.

Square-free vertex coloring

For our purposes, we are interested in coloring infinite graphs. This can not always be done with a finite number of colors : $K_{\mathbb{N}}$.

Theorem : Alon, Grytczuk, Haluszczak and Riordan

Every finite graph with maximum degree Δ can be colored with $2e^{16}\Delta^2$ colors.

Square-free vertex coloring

For our purposes, we are interested in coloring infinite graphs. This can not always be done with a finite number of colors : $K_{\mathbb{N}}$.

Theorem : Alon, Grytczuk, Haluszczak and Riordan

Every finite graph with maximum degree Δ can be colored with $2e^{16}\Delta^2$ colors.

It is possible to adapt the proof in order to obtain the following :
Let G be a group which is generated by a finite set S and let $\Gamma(G, S) = (G, \{\{g, gs\}, g \in G, s \in S\})$ be its undirected right Cayley graph.

Theorem

G admits a coloring of its undirected Cayley graph $\Gamma(G, S)$ with $2^{19}|S|^2$ colors.

Proof sketch

- Choose a coloring of the graph uniformly :
 $\forall g \in G, a \in \mathcal{A}, \mathbb{P}(\{x \in \mathcal{A}^{\Gamma(G,S)} \mid x_g = a\}) = 1/|\mathcal{A}|.$

Proof sketch

- Choose a coloring of the graph uniformly :
 $\forall g \in G, a \in \mathcal{A}, \mathbb{P}(\{x \in \mathcal{A}^{\Gamma(G,S)} \mid x_g = a\}) = 1/|\mathcal{A}|.$
- The probability of the event : A_p : a configuration has a square path p of length $2n - 1$ is $|\mathcal{A}|^{-n}.$

Proof sketch

- Choose a coloring of the graph uniformly :
 $\forall g \in G, a \in \mathcal{A}, \mathbb{P}(\{x \in \mathcal{A}^{\Gamma(G,S)} \mid x_g = a\}) = 1/|\mathcal{A}|.$
- The probability of the event : A_p : a configuration has a square path p of length $2n - 1$ is $|\mathcal{A}|^{-n}.$
- Setting $x(A_p) = (8|S|^2)^{-n}$ for a path of length $2n - 1$ satisfies LLL if $|\mathcal{A}| > 2^{19}|S|^2.$

The construction

Let $|\mathcal{A}| \geq 2^{19}|\mathcal{S}|^2$ and $X \subset \mathcal{A}^G$ be the subshift such that every square in $\Gamma(G, \mathcal{S})$ is forbidden.

The construction

Let $|\mathcal{A}| \geq 2^{19}|\mathcal{S}|^2$ and $X \subset \mathcal{A}^G$ be the subshift such that every square in $\Gamma(G, \mathcal{S})$ is forbidden.

- The previous result implies that $X \neq \emptyset$.

The construction

Let $|\mathcal{A}| \geq 2^{19}|\mathcal{S}|^2$ and $X \subset \mathcal{A}^G$ be the subshift such that every square in $\Gamma(G, \mathcal{S})$ is forbidden.

- The previous result implies that $X \neq \emptyset$.
- Let $g \in G$ such that $\sigma_g(x) = x$ for some $x \in X$.

The construction

Let $|\mathcal{A}| \geq 2^{19}|S|^2$ and $X \subset \mathcal{A}^G$ be the subshift such that every square in $\Gamma(G, S)$ is forbidden.

- The previous result implies that $X \neq \emptyset$.
- Let $g \in G$ such that $\sigma_g(x) = x$ for some $x \in X$.
- Factorize g as uvw with $u = v^{-1}$ and $|w|$ minimal (as a word on $(S \cup S^{-1})^*$). If $|w| = 0$, then $g = 1$.
- If not, let $w = w_1 \dots w_n$ and consider the odd length walk $\pi = v_0 v_1 \dots v_{2n-1}$ on $\Gamma(G, S)$ defined by :

$$v_i = \begin{cases} 1 & \text{if } i = 0 \\ w_1 \dots w_i & \text{if } i \in \{1, \dots, n\} \\ ww_1 \dots w_{i-n} & \text{if } i \in \{n+1, \dots, 2n-1\} \end{cases}$$

The construction

Let $|\mathcal{A}| \geq 2^{19}|S|^2$ and $X \subset \mathcal{A}^G$ be the subshift such that every square in $\Gamma(G, S)$ is forbidden.

- The previous result implies that $X \neq \emptyset$.
- Let $g \in G$ such that $\sigma_g(x) = x$ for some $x \in X$.
- Factorize g as uvw with $u = v^{-1}$ and $|w|$ minimal (as a word on $(S \cup S^{-1})^*$). If $|w| = 0$, then $g = 1$.
- If not, let $w = w_1 \dots w_n$ and consider the odd length walk $\pi = v_0 v_1 \dots v_{2n-1}$ on $\Gamma(G, S)$ defined by :

$$v_i = \begin{cases} 1 & \text{if } i = 0 \\ w_1 \dots w_i & \text{if } i \in \{1, \dots, n\} \\ ww_1 \dots w_{i-n} & \text{if } i \in \{n+1, \dots, 2n-1\} \end{cases}$$

- One can prove that π is a path. and that $x_{v_i} = x_{v_{i+n}}$. Yielding a contradiction.

The construction

Let $|\mathcal{A}| \geq 2^{19}|\mathcal{S}|^2$ and $X \subset \mathcal{A}^G$ be the subshift such that every square in $\Gamma(G, \mathcal{S})$ is forbidden.

- The previous result implies that $X \neq \emptyset$.
- Let $g \in G$ such that $\sigma_g(x) = x$ for some $x \in X$.
- Factorize g as uvw with $u = v^{-1}$ and $|w|$ minimal (as a word on $(\mathcal{S} \cup \mathcal{S}^{-1})^*$). If $|w| = 0$, then $g = 1$.
- If not, let $w = w_1 \dots w_n$ and consider the odd length walk $\pi = v_0 v_1 \dots v_{2n-1}$ on $\Gamma(G, \mathcal{S})$ defined by :

$$v_i = \begin{cases} 1 & \text{if } i = 0 \\ w_1 \dots w_i & \text{if } i \in \{1, \dots, n\} \\ ww_1 \dots w_{i-n} & \text{if } i \in \{n+1, \dots, 2n-1\} \end{cases}$$

- One can prove that π is a path. and that $x_{v_i} = x_{v_{i+n}}$. Yielding a contradiction.
- Therefore, $g = 1$.

Conclusion

What we have shown here :

Every finitely generated group admits a non-empty aperiodic subshift over (a big) alphabet.

Conclusion

What we have shown here :

Every finitely generated group admits a non-empty aperiodic subshift over (a big) alphabet.

Actually, we can prove the original result and add some extra spice.

Theorem : Aubrun, B, Thomassé

Every countable group G admits a non-empty aperiodic subshift over $\{0, 1\}$. Moreover, if G is finitely generated and has decidable word problem then the subshift is defined by a recursively enumerable set of forbidden patterns

Conclusion

What we have shown here :

Every finitely generated group admits a non-empty aperiodic subshift over (a big) alphabet.

Actually, we can prove the original result and add some extra spice.

Theorem : Aubrun, B, Thomassé

Every countable group G admits a non-empty aperiodic subshift over $\{0, 1\}$. Moreover, if G is finitely generated and has decidable word problem then the subshift is defined by a recursively enumerable set of forbidden patterns

Is it possible to use this construction to produce aperiodic SFTs?

Merci beaucoup pour votre attention !