

Strongly aperiodic subshifts in countable groups.

Sebastián Barbieri

LIP, ENS de Lyon – CNRS – INRIA – UCBL – Université de Lyon

Séminaire de Combinatoire et Théorie de Nombres
March, 2016

A dynamical system is a pair (X, T) where X is a topological space and $T : G \curvearrowright X$ is a group action by homeomorphisms of X .

A dynamical system is a pair (X, T) where X is a topological space and $T : G \curvearrowright X$ is a group action by homeomorphisms of X .

A \mathbb{Z} -action by homeomorphisms.

$T : \mathbb{R}^2/\mathbb{Z}^2 \rightarrow \mathbb{R}^2/\mathbb{Z}^2$ given by $T(x, y) = (2x + y, x + y) \pmod{1}$.

A dynamical system is a pair (X, T) where X is a topological space and $T : G \curvearrowright X$ is a group action by homeomorphisms of X .

A \mathbb{Z} -action by homeomorphisms.

$T : \mathbb{R}^2/\mathbb{Z}^2 \rightarrow \mathbb{R}^2/\mathbb{Z}^2$ given by $T(x, y) = (2x + y, x + y) \pmod{1}$.

A dynamical system is a pair (X, T) where X is a topological space and $T : G \curvearrowright X$ is a group action by homeomorphisms of X .

A \mathbb{Z} -action by homeomorphisms.

$T : \mathbb{R}^2/\mathbb{Z}^2 \rightarrow \mathbb{R}^2/\mathbb{Z}^2$ given by $T(x, y) = (2x + y, x + y) \pmod{1}$.



A dynamical system is a pair (X, T) where X is a topological space and $T : G \curvearrowright X$ is a group action by homeomorphisms of X .

A \mathbb{Z} -action by homeomorphisms.

$T : \mathbb{R}^2/\mathbb{Z}^2 \rightarrow \mathbb{R}^2/\mathbb{Z}^2$ given by $T(x, y) = (2x + y, x + y) \pmod{1}$.

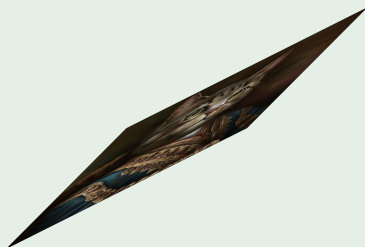

Motivation

A dynamical system is a pair (X, T) where X is a topological space and $T : G \curvearrowright X$ is a group action by homeomorphisms of X .

A \mathbb{Z} -action by homeomorphisms.

$T : \mathbb{R}^2/\mathbb{Z}^2 \rightarrow \mathbb{R}^2/\mathbb{Z}^2$ given by $T(x, y) = (2x + y, x + y) \pmod{1}$.

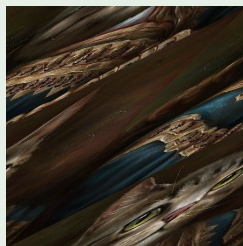
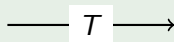

Motivation

A dynamical system is a pair (X, T) where X is a topological space and $T : G \curvearrowright X$ is a group action by homeomorphisms of X .

A \mathbb{Z} -action by homeomorphisms.

$T : \mathbb{R}^2/\mathbb{Z}^2 \rightarrow \mathbb{R}^2/\mathbb{Z}^2$ given by $T(x, y) = (2x + y, x + y) \pmod{1}$.



$\longrightarrow T^2 \longrightarrow$

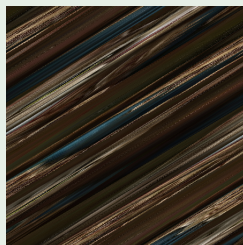

Motivation

A dynamical system is a pair (X, T) where X is a topological space and $T : G \curvearrowright X$ is a group action by homeomorphisms of X .

A \mathbb{Z} -action by homeomorphisms.

$T : \mathbb{R}^2/\mathbb{Z}^2 \rightarrow \mathbb{R}^2/\mathbb{Z}^2$ given by $T(x, y) = (2x + y, x + y) \pmod{1}$.



$\longrightarrow T^3 \longrightarrow$

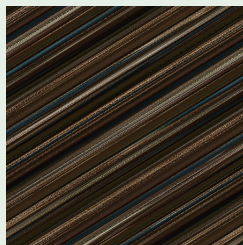

A dynamical system might be complicated. A good idea is to code its trajectories using a partition.

A \mathbb{Z} -action by homeomorphisms.

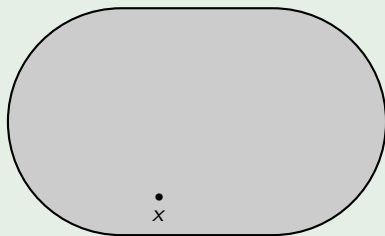

Coding of an orbit

A dynamical system might be complicated. A good idea is to code its trajectories using a partition.

A \mathbb{Z} -action by homeomorphisms.

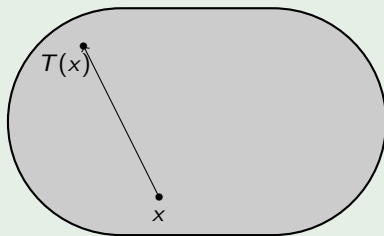

Coding of an orbit

A dynamical system might be complicated. A good idea is to code its trajectories using a partition.

A \mathbb{Z} -action by homeomorphisms.

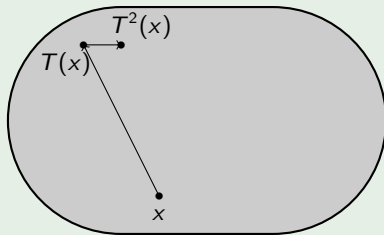

Coding of an orbit

A dynamical system might be complicated. A good idea is to code its trajectories using a partition.

A \mathbb{Z} -action by homeomorphisms.

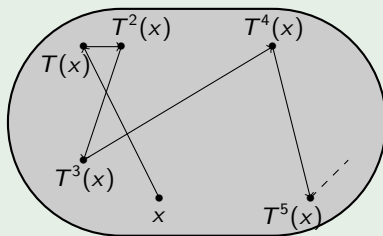

Coding of an orbit

A dynamical system might be complicated. A good idea is to code its trajectories using a partition.

A \mathbb{Z} -action by homeomorphisms.

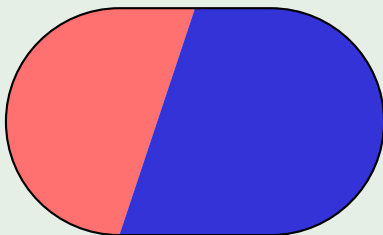

Coding of an orbit

A dynamical system might be complicated. A good idea is to code its trajectories using a partition.

A \mathbb{Z} -action by homeomorphisms.

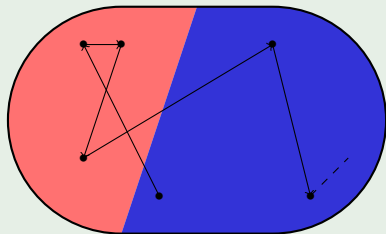

$$\varphi(x) = \cdots \text{ [blue] [red] [red] [red] [blue] } \cdots \in \{\bullet, \bullet\}^{\mathbb{Z}}$$

Coding of an orbit

A dynamical system might be complicated. A good idea is to code its trajectories using a partition.

A \mathbb{Z} -action by homeomorphisms.

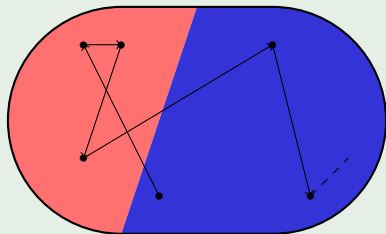

$$\varphi(x) = \cdots \text{ [blue] [red] [red] [red] [blue] } \cdots \in \{\bullet, \bullet\}^{\mathbb{Z}}$$

- ▷ Note that shifting $\varphi(x)$ yields $\varphi(T(x))$ and so on...
- ▷ In the case of a group action, $\varphi(x) \in \{\bullet, \bullet\}^G$.

Why would coding be a good idea?

- Instead of a complicated group action we get a shift action.
- If the coding is “good”, dynamical properties are preserved.
- Easier to describe, run algorithms, etc.

Why would coding be a good idea?

- Instead of a complicated group action we get a shift action.
- If the coding is “good”, dynamical properties are preserved.
- Easier to describe, run algorithms, etc.

Theorem

*If X is a Cantor space and T is an **expansive** action then (X, T) is conjugate to a symbolic system (a subshift).*

- ▶ G is a countable group.
- ▶ \mathcal{A} is a finite alphabet. Ex : $\mathcal{A} = \{0, 1\}$.
- ▶ \mathcal{A}^G is the set of configurations, $x : G \rightarrow \mathcal{A}$
- ▶ $\sigma : G \times \mathcal{A}^G \rightarrow \mathcal{A}^G$ is the left shift action given by :

$$\sigma(h, x)_g := \sigma^h(x)_g = x_{h^{-1}g}.$$

- ▶ G is a countable group.
- ▶ \mathcal{A} is a finite alphabet. Ex : $\mathcal{A} = \{0, 1\}$.
- ▶ \mathcal{A}^G is the set of configurations, $x : G \rightarrow \mathcal{A}$
- ▶ $\sigma : G \times \mathcal{A}^G \rightarrow \mathcal{A}^G$ is the left shift action given by :

$$\sigma(h, x)_g := \sigma^h(x)_g = x_{h^{-1}g}.$$

Definition : full G -shift

The pair (\mathcal{A}^G, σ) is called the *full G -shift*.

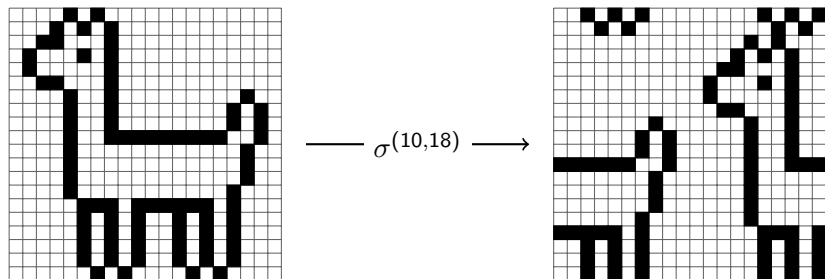

FIGURE: A configuration $x \in \{\blacksquare, \square\}^{\mathbb{Z}^2/20\mathbb{Z}^2}$ and its image by $\sigma^{(10,18)}$.

Definition : G -subshift

$X \subset \mathcal{A}^G$ is a *subshift* if and only if it is invariant under the action of σ and closed for the product topology on \mathcal{A}^G .

Definition : G -subshift

$X \subset \mathcal{A}^G$ is a *subshift* if and only if it is invariant under the action of σ and closed for the product topology on \mathcal{A}^G .

Examples :

- ▶ $X = \{x \in \{0,1\}^{\mathbb{Z}} \mid \text{no two consecutive 1's in } x\}$
- ▶ $X = \{x \in \{0,1\}^G \mid \text{finite CC of 1's are of even length}\}$

Luckily, subshifts can also be described in a combinatorial way.

- A *pattern* is a finite configuration, i.e. $p \in \mathcal{A}^F$ where $F \subset G$ and $|F| < \infty$. We denote $\text{supp}(p) = F$.
- A *cylinder* is the set $[a]_g := \{x \in \mathcal{A}^G \mid x_g = a\}$.
-

$$[p] := \bigcap_{g \in \text{supp}(p)} [p_g]_g.$$

Luckily, subshifts can also be described in a combinatorial way.

- A *pattern* is a finite configuration, i.e. $p \in \mathcal{A}^F$ where $F \subset G$ and $|F| < \infty$. We denote $\text{supp}(p) = F$.
- A *cylinder* is the set $[a]_g := \{x \in \mathcal{A}^G \mid x_g = a\}$.
-

$$[p] := \bigcap_{g \in \text{supp}(p)} [p_g]_g.$$

Proposition

A subshift is a set of configurations avoiding patterns from a set \mathcal{F} .

$$X = X_{\mathcal{F}} := \mathcal{A}^G \setminus \bigcup_{g \in G, p \in \mathcal{F}} \sigma^g([p])$$

Example in \mathbb{Z}^2 : Hard-square shift

Example : Hard-square shift. X is the set of assignments of \mathbb{Z}^2 to $\{0, 1\}$ such that there are no two adjacent ones.

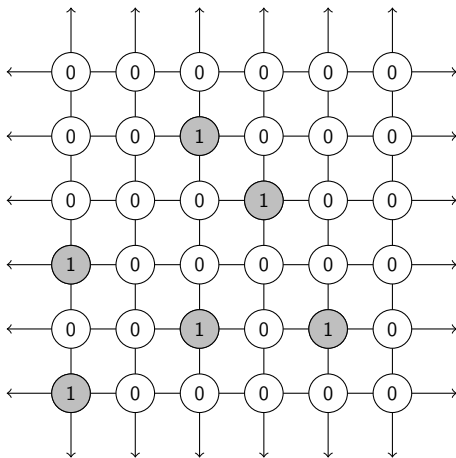
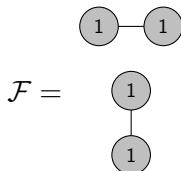

Example : one-or-less subshift

Example : one-or-less subshift.

$$X_{\leq 1} := \{x \in \{0, 1\}^G \mid 0 \notin \{x_u, x_v\} \implies u = v\}.$$

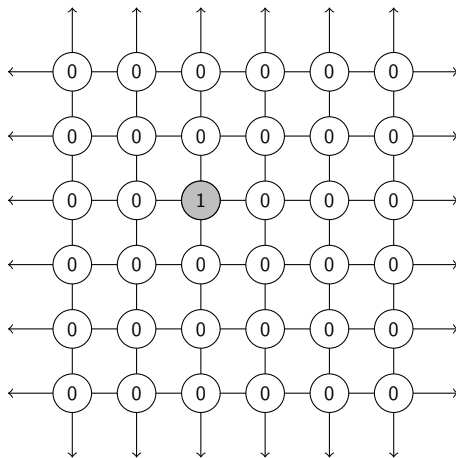

Example : Fibonacci in F_2 .

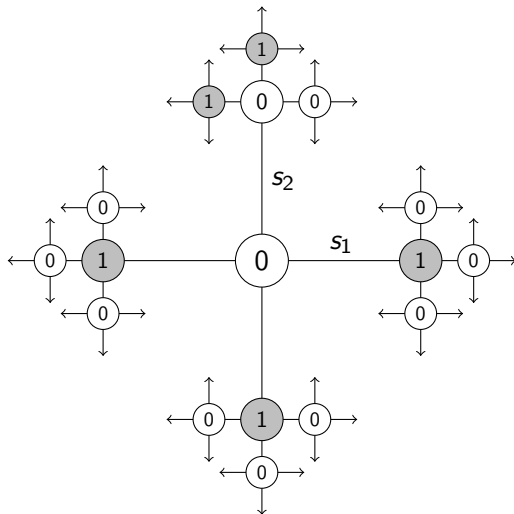
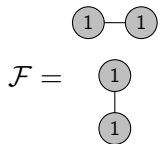

Example : Wang tiling

A subshift defined by Wang tiles : two tiles can be put next to each other only their adjacent colors match.

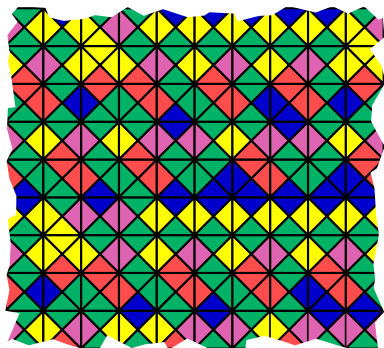
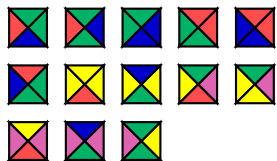

Subshifts of finite type (SFT)

Definition : subshift of finite type (SFT)

A *subshift of finite type (SFT)* is a subshift that can be defined by a finite set of forbidden patterns.

Subshifts of finite type (SFT)

Definition : subshift of finite type (SFT)

A *subshift of finite type (SFT)* is a subshift that can be defined by a finite set of forbidden patterns.

- ▶ A simple class with respect to the combinatorial definition
- ▶ 2D-SFT \equiv Wang tilings.

Strongly aperiodic subshifts

Definition (Strongly aperiodic subshift)

A subshift $X \subset A^G$ is *strongly aperiodic* if all its configurations have trivial stabilizer

$$\forall x \in X, \forall g \in G, \sigma^g(x) = x \Rightarrow g = 1_G.$$

Strongly aperiodic subshifts

Definition (Strongly aperiodic subshift)

A subshift $X \subset A^G$ is *strongly aperiodic* if all its configurations have trivial stabilizer

$$\forall x \in X, \forall g \in G, \sigma^g(x) = x \Rightarrow g = 1_G.$$

Proposition

Every 1D non-empty SFT contains a periodic configuration.

Strongly aperiodic subshifts

Definition (Strongly aperiodic subshift)

A subshift $X \subset A^G$ is *strongly aperiodic* if all its configurations have trivial stabilizer

$$\forall x \in X, \forall g \in G, \sigma^g(x) = x \Rightarrow g = 1_G.$$

Proposition

Every 1D non-empty SFT contains a periodic configuration.

Theorem (Berger 1966, Robinson 1971, Kari & Culik 1996, Jeandel & Rao 2015)

There exist strongly aperiodic SFTs on \mathbb{Z}^2 .

Example of strongly aperiodic \mathbb{Z}^2 -SFT : Robinson tileset

The Robinson tileset, where tiles can be rotated.

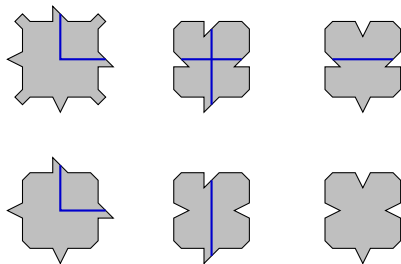

Example of strongly aperiodic \mathbb{Z}^2 -SFT : Robinson tileset

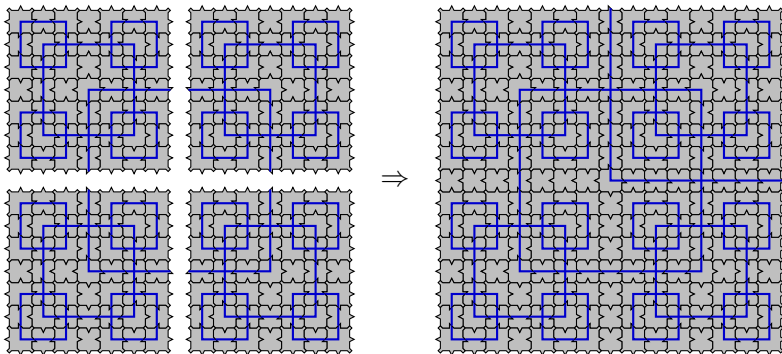

- ▶ If G is r.p. with a strongly aperiodic SFT, then G has decidable **WP** (Jeandel, 2015).

- ▶ If G is r.p. with a strongly aperiodic SFT, then G has decidable **WP** (Jeandel, 2015).
- ▶ If G has at least two ends, then it has no strongly aperiodic SFTs (Cohen, 2015)

- ▶ If G is r.p. with a strongly aperiodic SFT, then G has decidable **WP** (Jeandel, 2015).
- ▶ If G has at least two ends, then it has no strongly aperiodic SFTs (Cohen, 2015)
- ▶ Generalization of Kari's construction to some $G \times \mathbb{Z}$ (Jeandel, 2015).

- ▶ If G is r.p. with a strongly aperiodic SFT, then G has decidable **WP** (Jeandel, 2015).
- ▶ If G has at least two ends, then it has no strongly aperiodic SFTs (Cohen, 2015)
- ▶ Generalization of Kari's construction to some $G \times \mathbb{Z}$ (Jeandel, 2015).
- ▶ Discrete Heisenberg group (Sahin, Schraudner & Ugarcovici, 2015).

- ▶ If G is r.p. with a strongly aperiodic SFT, then G has decidable **WP** (Jeandel, 2015).
- ▶ If G has at least two ends, then it has no strongly aperiodic SFTs (Cohen, 2015)
- ▶ Generalization of Kari's construction to some $G \times \mathbb{Z}$ (Jeandel, 2015).
- ▶ Discrete Heisenberg group (Sahin, Schraudner & Ugarcovici, 2015).
- ▶ Surface groups (Cohen & Goodman-Strauss, 2015).

- ▶ If G is r.p. with a strongly aperiodic SFT, then G has decidable **WP** (Jeandel, 2015).
- ▶ If G has at least two ends, then it has no strongly aperiodic SFTs (Cohen, 2015)
- ▶ Generalization of Kari's construction to some $G \times \mathbb{Z}$ (Jeandel, 2015).
- ▶ Discrete Heisenberg group (Sahin, Schraudner & Ugarcovici, 2015).
- ▶ Surface groups (Cohen & Goodman-Strauss, 2015).
- ▶ groups $\mathbb{Z}^2 \rtimes H$ where H has decidable **WP** (B & Sablik, 2016).

Some recent partial results

It is not obvious to come up with examples of aperiodic subshifts in general groups even if no restrictions are supposed on the list of forbidden patterns.

Question by Glasner and Uspenskij 2009

Is there any countable group which does not admit any non-empty strongly aperiodic subshift on a two symbol alphabet?

Some recent partial results

It is not obvious to come up with examples of aperiodic subshifts in general groups even if no restrictions are supposed on the list of forbidden patterns.

Question by Glasner and Uspenskij 2009

Is there any countable group which does not admit any non-empty strongly aperiodic subshift on a two symbol alphabet?

Theorem by Gao, Jackson and Seward 2009

No. All do.

And their proof is a quite technical construction.

A new short proof

However! It is possible to show the same result by using tools from probability and combinatorics.

However! It is possible to show the same result by using tools from probability and combinatorics.

Theorem by Aubrun, B, Thomassé

No. All do.

But now the proof is short. It uses the asymmetrical version of Lovász Local Lemma.

Lovász Local Lemma (Asymmetrical version)

Let $\mathcal{A} := \{A_1, A_2, \dots, A_n\}$ be a finite collection of measurable sets in a probability space (X, μ, \mathcal{B}) . For $A \in \mathcal{A}$, let $\Gamma(A)$ be the smallest subset of \mathcal{A} such that A is independent of the collection $\mathcal{A} \setminus (\{A\} \cup \Gamma(A))$. Suppose there exists a function $x : \mathcal{A} \rightarrow (0, 1)$ such that :

$$\forall A \in \mathcal{A} : \mu(A) \leq x(A) \prod_{B \in \Gamma(A)} (1 - x(B))$$

then the probability of avoiding all events in \mathcal{A} is positive, in particular :

$$\mu \left(X \setminus \bigcup_{i=1}^n A_i \right) \geq \prod_{A \in \mathcal{A}} (1 - x(A)) > 0.$$

A sufficient condition for being non-empty

Let G a countable group and $X \subset \mathcal{A}^G$ a subshift defined by the set of forbidden patterns $\mathcal{F} = \bigcup_{n \geq 1} \mathcal{F}_n$, where $\mathcal{F}_n \subset \mathcal{A}^{S_n}$. Suppose that there exists a function $x : \mathbb{N} \times G \rightarrow (0, 1)$ such that :

$$\forall n \in \mathbb{N}, g \in G, \mu(A_{n,g}) \leq x(n, g) \prod_{\substack{gS_n \cap hS_k \neq \emptyset \\ (k,h) \neq (n,g)}} (1 - x(k, h)),$$

where $A_{n,g} = \{x \in \mathcal{A}^G : x|_{gS_n} \in \mathcal{F}_n\}$ and μ is any Bernoulli probability measure on \mathcal{A}^G . Then the subshift X is non-empty.

Proof of the theorem

We say $x \in \{0, 1\}^G$ has *the distinct neighborhood property* if for every $h \in G \setminus \{1_G\}$ there exists a finite subset $T \subset G$ such that :

$$\forall g \in G : x|_{ghT} \neq x|_{gT}.$$

We say $x \in \{0, 1\}^G$ has *the distinct neighborhood property* if for every $h \in G \setminus \{1_G\}$ there exists a finite subset $T \subset G$ such that :

$$\forall g \in G : x|_{ghT} \neq x|_{gT}.$$

Proposition

If x has the distinct neighborhood property then $\overline{\text{orb}_\sigma(x)}$ is strongly aperiodic.

Proof of the theorem

It suffices to show that there is $x \in \{0, 1\}^G$ with the distinct neighborhood property.

Proof of the theorem

It suffices to show that there is $x \in \{0, 1\}^G$ with the distinct neighborhood property.

Ingredients

- ▶ A constant $C \in \mathbb{N}$.
- ▶ An enumeration s_1, s_2, \dots of G .
- ▶ $(T_i)_{i \in \mathbb{N}}$ a sequence of finite subsets of G such that for every $i \in \mathbb{N}$, $T_i \cap s_i T_i = \emptyset$ and $|T_i| = C \cdot i$.
- ▶ The uniform Bernoulli measure μ
- ▶ $\mathcal{A} := \{A_{n,g}\}_{n \geq 1, g \in G}$
- ▶ $A_{n,g} = \{x \in \{0, 1\}^G \mid x|_{gT_n} = x|_{gs_n T_n}\}$
- ▶ $x(A_{n,g}) := 2^{-\frac{Cn}{2}}$

Proof : On the blackboard.

We have shown :

Theorem

Every countable group has a non-empty, strongly aperiodic subshift on the alphabet $\{0, 1\}$.

We have shown :

Theorem

Every countable group has a non-empty, strongly aperiodic subshift on the alphabet $\{0, 1\}$.

But we can show something more :

Theorem (Aubrun, B, Thomassé)

Every finitely generated group G with decidable word problem has a non-empty, effectively closed strongly aperiodic subshift.

Effectively closed subshift

Definition : Effectively closed subshift.

A subshift is *effectively closed* if it can be defined by a recursively enumerable coding of a set of forbidden patterns \mathcal{F} .

Effectively closed subshift

Definition : Effectively closed subshift.

A subshift is *effectively closed* if it can be defined by a recursively enumerable coding of a set of forbidden patterns \mathcal{F} .

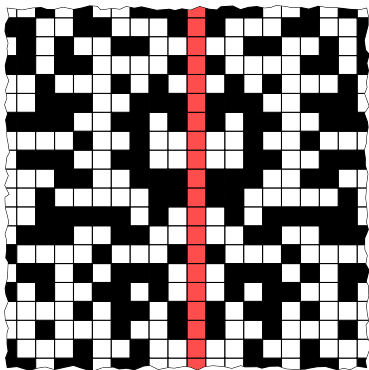

Square-free vertex coloring

Let $G = (V, E)$ be a graph. A vertex coloring is a function $x : V \rightarrow \mathcal{A}$. We say it is square-free if for every odd-length path $p = v_1 \dots v_{2n}$ then there exists $1 \leq j \leq n$ such that $x(v_j) \neq x(v_{j+n})$.

Square-free vertex coloring

Square-free vertex coloring

Let $G = (V, E)$ be a graph. A vertex coloring is a function $x : V \rightarrow \mathcal{A}$. We say it is square-free if for every odd-length path $p = v_1 \dots v_{2n}$ then there exists $1 \leq j \leq n$ such that $x(v_j) \neq x(v_{j+n})$.

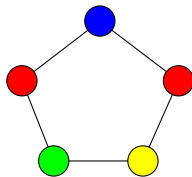
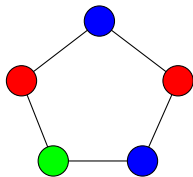

C_5 has a square-free vertex coloring with 4 colors, but not with 3.

Square-free vertex coloring

For our purposes, we are interested in coloring infinite graphs. This can not always be done with a finite number of colors : $K_{\mathbb{N}}$.

Square-free vertex coloring

For our purposes, we are interested in coloring infinite graphs. This can not always be done with a finite number of colors : $K_{\mathbb{N}}$.

Theorem : Alon, Grytczuk, Haluszczak and Riordan

Every finite graph with maximum degree Δ can be colored with $2e^{16}\Delta^2$ colors.

Square-free vertex coloring

For our purposes, we are interested in coloring infinite graphs. This can not always be done with a finite number of colors : $K_{\mathbb{N}}$.

Theorem : Alon, Grytczuk, Haluszczak and Riordan

Every finite graph with maximum degree Δ can be colored with $2e^{16}\Delta^2$ colors.

It is possible to adapt the proof in order to obtain the following :
Let G be a group which is generated by a finite set S and let $\Gamma(G, S) = (G, \{\{g, gs\}, g \in G, s \in S\})$ be its undirected right Cayley graph.

Theorem

G admits a coloring of its undirected Cayley graph $\Gamma(G, S)$ with $2^{19}|S|^2$ colors.

The proof idea

Let $|\mathcal{A}| \geq 2^{19}|S|^2$ and $X \subset \mathcal{A}^G$ be the subshift such that every square in $\Gamma(G, S)$ is forbidden.

The proof idea

Let $|\mathcal{A}| \geq 2^{19}|S|^2$ and $X \subset \mathcal{A}^G$ be the subshift such that every square in $\Gamma(G, S)$ is forbidden.

- The previous result implies that $X \neq \emptyset$.

The proof idea

Let $|\mathcal{A}| \geq 2^{19}|S|^2$ and $X \subset \mathcal{A}^G$ be the subshift such that every square in $\Gamma(G, S)$ is forbidden.

- The previous result implies that $X \neq \emptyset$.
- Let $g \in G$ such that $\sigma^g(x) = x$ for some $x \in X$.

The proof idea

Let $|\mathcal{A}| \geq 2^{19}|S|^2$ and $X \subset \mathcal{A}^G$ be the subshift such that every square in $\Gamma(G, S)$ is forbidden.

- The previous result implies that $X \neq \emptyset$.
- Let $g \in G$ such that $\sigma^g(x) = x$ for some $x \in X$.
- Factorize g as uvw with $u = v^{-1}$ and $|w|$ minimal (as a word on $(S \cup S^{-1})^*$). If $|w| = 0$, then $g = 1_G$.

The proof idea

Let $|\mathcal{A}| \geq 2^{19}|S|^2$ and $X \subset \mathcal{A}^G$ be the subshift such that every square in $\Gamma(G, S)$ is forbidden.

- The previous result implies that $X \neq \emptyset$.
- Let $g \in G$ such that $\sigma^g(x) = x$ for some $x \in X$.
- Factorize g as uvw with $u = v^{-1}$ and $|w|$ minimal (as a word on $(S \cup S^{-1})^*$). If $|w| = 0$, then $g = 1_G$.
- If not, let $w = w_1 \dots w_n$ and consider the odd length walk $\pi = v_0 v_1 \dots v_{2n-1}$ on $\Gamma(G, S)$ defined by :

$$v_i = \begin{cases} 1_G & \text{if } i = 0 \\ w_1 \dots w_i & \text{if } i \in \{1, \dots, n\} \\ ww_1 \dots w_{i-n} & \text{if } i \in \{n+1, \dots, 2n-1\} \end{cases}$$

The proof idea

Let $|\mathcal{A}| \geq 2^{19}|S|^2$ and $X \subset \mathcal{A}^G$ be the subshift such that every square in $\Gamma(G, S)$ is forbidden.

- The previous result implies that $X \neq \emptyset$.
- Let $g \in G$ such that $\sigma^g(x) = x$ for some $x \in X$.
- Factorize g as uvw with $u = v^{-1}$ and $|w|$ minimal (as a word on $(S \cup S^{-1})^*$). If $|w| = 0$, then $g = 1_G$.
- If not, let $w = w_1 \dots w_n$ and consider the odd length walk $\pi = v_0 v_1 \dots v_{2n-1}$ on $\Gamma(G, S)$ defined by :

$$v_i = \begin{cases} 1_G & \text{if } i = 0 \\ w_1 \dots w_i & \text{if } i \in \{1, \dots, n\} \\ ww_1 \dots w_{i-n} & \text{if } i \in \{n+1, \dots, 2n-1\} \end{cases}$$

- One can prove that π is a path. and that $x_{v_i} = x_{v_{i+n}}$. Yielding a contradiction.

The proof idea

Let $|\mathcal{A}| \geq 2^{19}|S|^2$ and $X \subset \mathcal{A}^G$ be the subshift such that every square in $\Gamma(G, S)$ is forbidden.

- The previous result implies that $X \neq \emptyset$.
- Let $g \in G$ such that $\sigma^g(x) = x$ for some $x \in X$.
- Factorize g as uvw with $u = v^{-1}$ and $|w|$ minimal (as a word on $(S \cup S^{-1})^*$). If $|w| = 0$, then $g = 1_G$.
- If not, let $w = w_1 \dots w_n$ and consider the odd length walk $\pi = v_0 v_1 \dots v_{2n-1}$ on $\Gamma(G, S)$ defined by :

$$v_i = \begin{cases} 1_G & \text{if } i = 0 \\ w_1 \dots w_i & \text{if } i \in \{1, \dots, n\} \\ ww_1 \dots w_{i-n} & \text{if } i \in \{n+1, \dots, 2n-1\} \end{cases}$$

- One can prove that π is a path. and that $x_{v_i} = x_{v_{i+n}}$. Yielding a contradiction.
- Therefore, $g = 1_G$.

Theorem (Aubrun, B, Thomassé)

Every finitely generated group with decidable word problem admits a non-empty, effectively closed, strongly aperiodic subshift.

Theorem (Aubrun, B, Thomassé)

Every finitely generated group with decidable word problem admits a non-empty, effectively closed, strongly aperiodic subshift.

Putting it together with a result from Jeandel we get :

Theorem

Let G be a recursively presented group. There exists a non-empty effectively closed strongly aperiodic G -subshift if and only if the word problem of G is decidable.

Another application is producing strongly aperiodic SFTs. Using a simulation theorem (A generalization of Hochman's result from 2008). We can prove the following :

Another application is producing strongly aperiodic SFTs. Using a simulation theorem (A generalization of Hochman's result from 2008). We can prove the following :

Theorem (B, Sablik (2017))

Let G be a finitely generated group with decidable word problem. Then $\mathbb{Z}^2 \rtimes G$ admits a non-empty strongly aperiodic SFT.

Thank you for your attention !