

Symbolic dynamics and simulation theorems

Sebastián Barbieri Lemp

LIP, ENS de Lyon – CNRS – INRIA – UCBL – Université de Lyon

Séminaire AUTOMATA, IRIF

May, 2017

A dynamical system is a pair (X, T) where X is a topological space and $T : G \curvearrowright X$ is a group action by homeomorphisms of X .

A dynamical system is a pair (X, T) where X is a topological space and $T : G \curvearrowright X$ is a group action by homeomorphisms of X .

A \mathbb{Z} -action by homeomorphisms.

$T : \mathbb{R}^2/\mathbb{Z}^2 \rightarrow \mathbb{R}^2/\mathbb{Z}^2$ given by $T(x, y) = (2x + y, x + y) \pmod{1}$.

A dynamical system is a pair (X, T) where X is a topological space and $T : G \curvearrowright X$ is a group action by homeomorphisms of X .

A \mathbb{Z} -action by homeomorphisms.

$T : \mathbb{R}^2/\mathbb{Z}^2 \rightarrow \mathbb{R}^2/\mathbb{Z}^2$ given by $T(x, y) = (2x + y, x + y) \pmod{1}$.

A dynamical system is a pair (X, T) where X is a topological space and $T : G \curvearrowright X$ is a group action by homeomorphisms of X .

A \mathbb{Z} -action by homeomorphisms.

$T : \mathbb{R}^2/\mathbb{Z}^2 \rightarrow \mathbb{R}^2/\mathbb{Z}^2$ given by $T(x, y) = (2x + y, x + y) \pmod{1}$.



A dynamical system is a pair (X, T) where X is a topological space and $T : G \curvearrowright X$ is a group action by homeomorphisms of X .

A \mathbb{Z} -action by homeomorphisms.

$T : \mathbb{R}^2/\mathbb{Z}^2 \rightarrow \mathbb{R}^2/\mathbb{Z}^2$ given by $T(x, y) = (2x + y, x + y) \pmod{1}$.

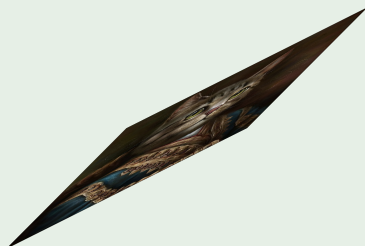

Motivation

A dynamical system is a pair (X, T) where X is a topological space and $T : G \curvearrowright X$ is a group action by homeomorphisms of X .

A \mathbb{Z} -action by homeomorphisms.

$T : \mathbb{R}^2/\mathbb{Z}^2 \rightarrow \mathbb{R}^2/\mathbb{Z}^2$ given by $T(x, y) = (2x + y, x + y) \pmod{1}$.

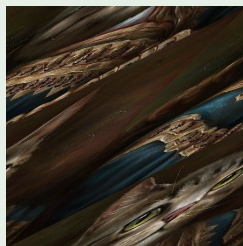
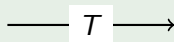

Motivation

A dynamical system is a pair (X, T) where X is a topological space and $T : G \curvearrowright X$ is a group action by homeomorphisms of X .

A \mathbb{Z} -action by homeomorphisms.

$T : \mathbb{R}^2/\mathbb{Z}^2 \rightarrow \mathbb{R}^2/\mathbb{Z}^2$ given by $T(x, y) = (2x + y, x + y) \pmod{1}$.



$\longrightarrow T^2 \longrightarrow$

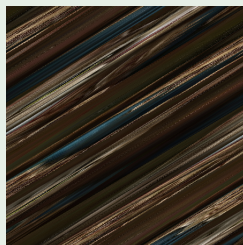

Motivation

A dynamical system is a pair (X, T) where X is a topological space and $T : G \curvearrowright X$ is a group action by homeomorphisms of X .

A \mathbb{Z} -action by homeomorphisms.

$T : \mathbb{R}^2/\mathbb{Z}^2 \rightarrow \mathbb{R}^2/\mathbb{Z}^2$ given by $T(x, y) = (2x + y, x + y) \pmod{1}$.



$\longrightarrow T^3 \longrightarrow$

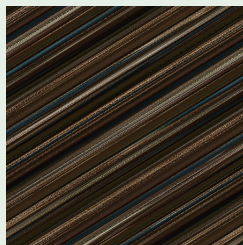

Coding of an orbit

A dynamical system might be complicated. A good idea is to code its trajectories using a partition.

A \mathbb{Z} -action by homeomorphisms.

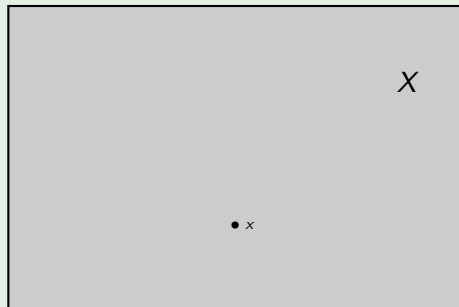

Coding of an orbit

A dynamical system might be complicated. A good idea is to code its trajectories using a partition.

A \mathbb{Z} -action by homeomorphisms.

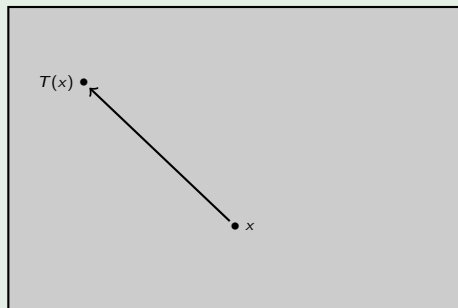

Coding of an orbit

A dynamical system might be complicated. A good idea is to code its trajectories using a partition.

A \mathbb{Z} -action by homeomorphisms.

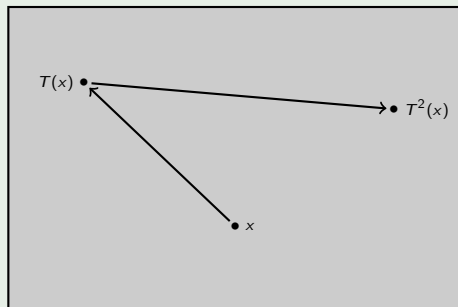

Coding of an orbit

A dynamical system might be complicated. A good idea is to code its trajectories using a partition.

A \mathbb{Z} -action by homeomorphisms.

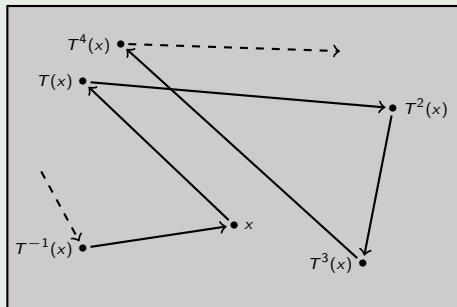

Coding of an orbit

A dynamical system might be complicated. A good idea is to code its trajectories using a partition.

A \mathbb{Z} -action by homeomorphisms.

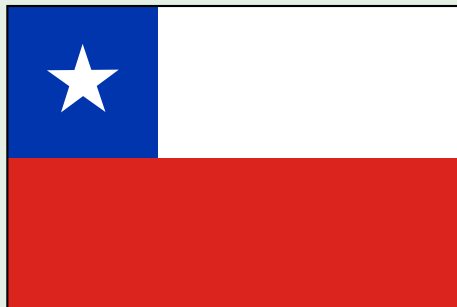

Coding of an orbit

A dynamical system might be complicated. A good idea is to code its trajectories using a partition.

A \mathbb{Z} -action by homeomorphisms.

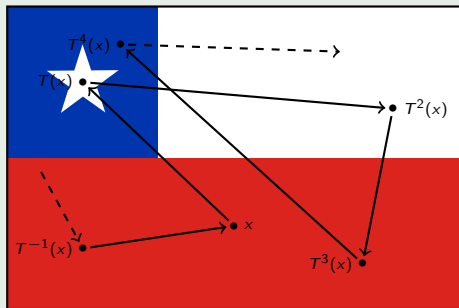

$$\varphi(x) = \cdots \begin{array}{cccccc} \color{red}\blacksquare & \color{red}\blacksquare & \color{white}\blacksquare & \color{white}\blacksquare & \color{red}\blacksquare & \color{blue}\blacksquare \\ -1 & 0 & 1 & 2 & 3 & 4 \end{array} \cdots \in \{\color{red}\blacksquare, \color{blue}\blacksquare, \color{white}\blacksquare\}^{\mathbb{Z}}$$

Coding of an orbit

A dynamical system might be complicated. A good idea is to code its trajectories using a partition.

A \mathbb{Z} -action by homeomorphisms.

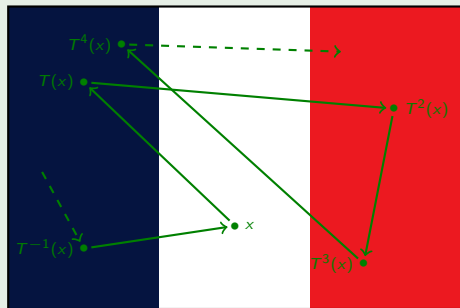

$$\varphi(x) = \cdots \begin{array}{cccc} \blacksquare & \square & \blacksquare & \color{red}\square & \color{red}\square & \blacksquare \end{array} \cdots \in \{\color{red}\square, \blacksquare, \square\}^{\mathbb{Z}}$$

-1 0 1 2 3 4

Why would coding be a good idea?

- Instead of a complicated homeomorphism we get a shift action.
- If the coding is “good”, dynamical properties are preserved.
- Easier to describe, run algorithms, etc.

Why would coding be a good idea?

- Instead of a complicated homeomorphism we get a shift action.
- If the coding is “good”, dynamical properties are preserved.
- Easier to describe, run algorithms, etc.

Theorem

*If X is a Cantor space and T is an **expansive** action then (X, T) is conjugate to a symbolic system (a subshift).*

- ▶ G is a countable group.
- ▶ \mathcal{A} is a finite alphabet. Ex: $\mathcal{A} = \{0, 1\}$.
- ▶ \mathcal{A}^G is the set of configurations, $x : G \rightarrow \mathcal{A}$
- ▶ $\sigma : G \times \mathcal{A}^G \rightarrow \mathcal{A}^G$ is the left shift action given by:

$$\sigma(h, x)_g := \sigma^h(x)_g = x_{h^{-1}g}.$$

- ▶ G is a countable group.
- ▶ \mathcal{A} is a finite alphabet. Ex: $\mathcal{A} = \{0, 1\}$.
- ▶ \mathcal{A}^G is the set of configurations, $x : G \rightarrow \mathcal{A}$
- ▶ $\sigma : G \times \mathcal{A}^G \rightarrow \mathcal{A}^G$ is the left shift action given by:

$$\sigma(h, x)_g := \sigma^h(x)_g = x_{h^{-1}g}.$$

Definition: full G -shift

The pair (\mathcal{A}^G, σ) is called the *full G -shift*.

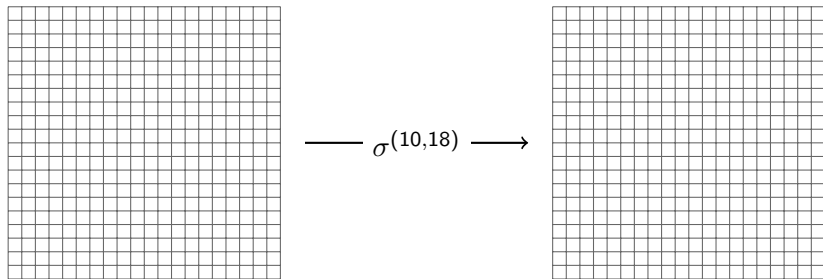

Figure: A random configuration $x \in \{\blacksquare, \square\}^{\mathbb{Z}^2/20\mathbb{Z}^2}$ and its image by $\sigma^{(10,18)}$.

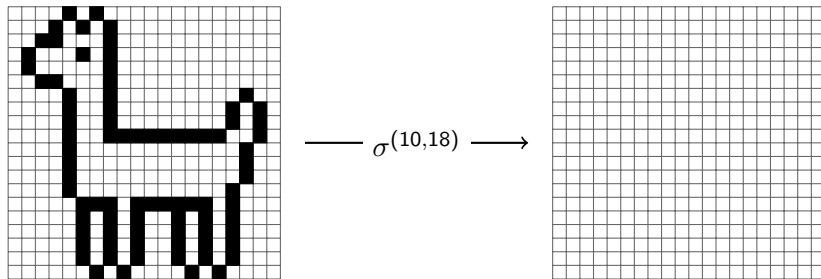

Figure: A random configuration $x \in \{\blacksquare, \square\}^{\mathbb{Z}^2/20\mathbb{Z}^2}$ and its image by $\sigma(10,18)$.

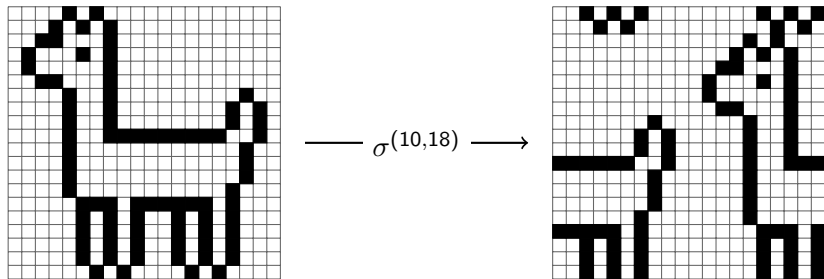

Figure: A random configuration $x \in \{\blacksquare, \square\}^{\mathbb{Z}^2/20\mathbb{Z}^2}$ and its image by $\sigma^{(10,18)}$.

Definition: G -subshift

$X \subset \mathcal{A}^G$ is a *subshift* if and only if it is invariant under the action of σ and closed for the product topology on \mathcal{A}^G .

Definition: G -subshift

$X \subset \mathcal{A}^G$ is a *subshift* if and only if it is invariant under the action of σ and closed for the product topology on \mathcal{A}^G .

Examples:

- ▶ $X = \{x \in \{0,1\}^{\mathbb{Z}} \mid \text{no two consecutive 1's in } x\}$
- ▶ $X = \{x \in \{0,1\}^G \mid \text{finite CC of 1's are of even length}\}$

Luckily, subshifts can also be described in a combinatorial way.

- A *pattern* is a finite configuration, i.e. $p \in \mathcal{A}^F$ where $F \subset G$ and $|F| < \infty$. We denote $\text{supp}(p) = F$.
- A *cylinder* is the set $[a]_g := \{x \in \mathcal{A}^G \mid x_g = a\}$.
-

$$[p] := \bigcap_{g \in \text{supp}(p)} [p_g]_g.$$

Luckily, subshifts can also be described in a combinatorial way.

- A *pattern* is a finite configuration, i.e. $p \in \mathcal{A}^F$ where $F \subset G$ and $|F| < \infty$. We denote $\text{supp}(p) = F$.
- A *cylinder* is the set $[a]_g := \{x \in \mathcal{A}^G \mid x_g = a\}$.
-

$$[p] := \bigcap_{g \in \text{supp}(p)} [p_g]_g.$$

Proposition

A subshift is a set of configurations avoiding patterns from a set \mathcal{F} .

$$X = X_{\mathcal{F}} := \mathcal{A}^G \setminus \bigcup_{g \in G, p \in \mathcal{F}} \sigma^g([p])$$

Example in \mathbb{Z}^2 : Hard-square shift

Example: Hard-square shift. X is the set of assignments of \mathbb{Z}^2 to $\{0, 1\}$ such that there are no two adjacent ones.

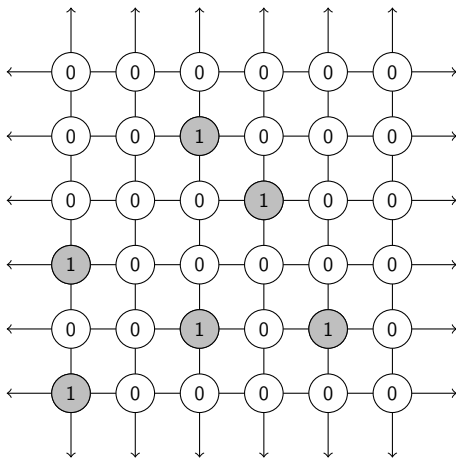
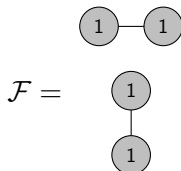

Example: one-or-less subshift

Example: one-or-less subshift.

$$X_{\leq 1} := \{x \in \{0, 1\}^G \mid 0 \notin \{x_u, x_v\} \implies u = v\}.$$

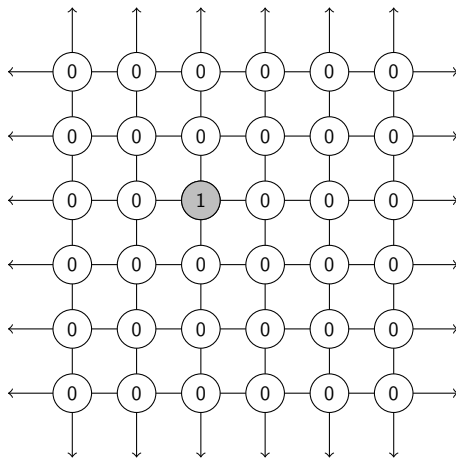

Example: Fibonacci in F_2 .

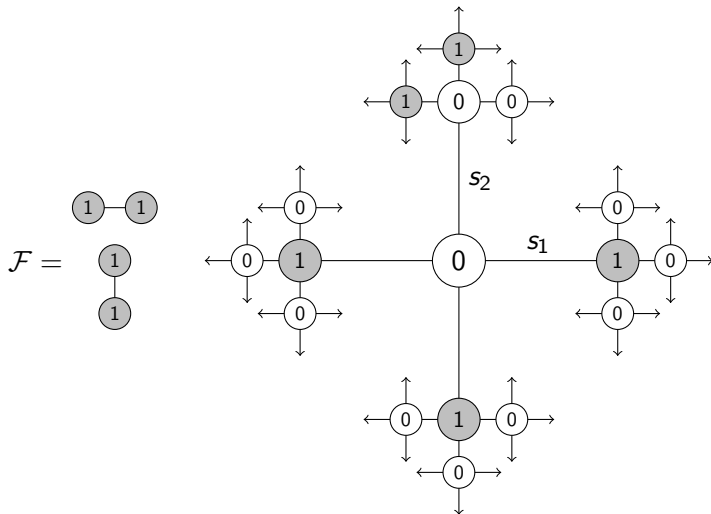

Example: Wang tiling

A subshift defined by Wang tiles: two tiles can be put next to each other only if their adjacent colors match.

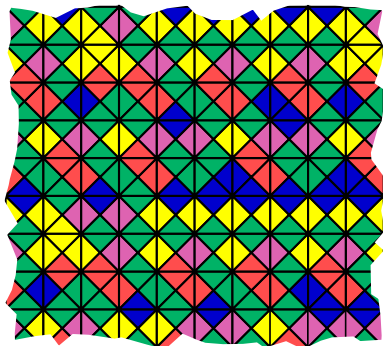
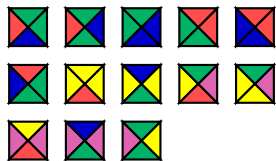

Subshifts of finite type (SFT)

Definition: subshift of finite type (SFT)

A *subshift of finite type (SFT)* is a subshift that can be defined by a finite set of forbidden patterns.

Subshifts of finite type (SFT)

Definition: subshift of finite type (SFT)

A *subshift of finite type (SFT)* is a subshift that can be defined by a finite set of forbidden patterns.

- ▶ A simple class with respect to the combinatorial definition
- ▶ 2D-SFT \equiv Wang tilings.

Definition (Strongly aperiodic subshift)

A subshift $X \subset A^G$ is *strongly aperiodic* if all its configurations have trivial stabilizer

$$\forall x \in X, \forall g \in G, \sigma^g(x) = x \Rightarrow g = 1_G.$$

Strongly aperiodic subshifts

Definition (Strongly aperiodic subshift)

A subshift $X \subset A^G$ is *strongly aperiodic* if all its configurations have trivial stabilizer

$$\forall x \in X, \forall g \in G, \sigma^g(x) = x \Rightarrow g = 1_G.$$

Proposition

Every 1D non-empty SFT contains a periodic configuration.

Strongly aperiodic subshifts

Definition (Strongly aperiodic subshift)

A subshift $X \subset A^G$ is *strongly aperiodic* if all its configurations have trivial stabilizer

$$\forall x \in X, \forall g \in G, \sigma^g(x) = x \Rightarrow g = 1_G.$$

Proposition

Every 1D non-empty SFT contains a periodic configuration.

Theorem (Berger 1966, Robinson 1971, Kari 1996, Jeandel & Rao 2015)

There exist strongly aperiodic SFTs on \mathbb{Z}^2 .

Example of strongly aperiodic \mathbb{Z}^2 -SFT: Robinson tileset

The Robinson tileset, where tiles can be rotated and reflected.

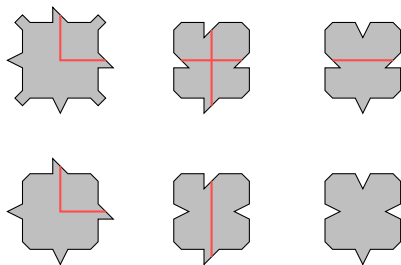

Example of strongly aperiodic \mathbb{Z}^2 -SFT: Robinson tileset

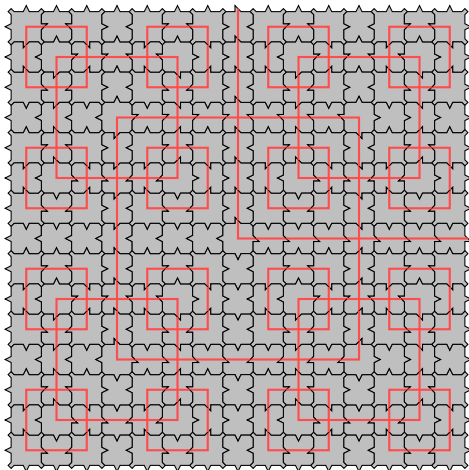

- ▶ If G is r.p. with a strongly aperiodic SFT, then G has decidable **WP** (Jeandel, 2015).

- ▶ If G is r.p. with a strongly aperiodic SFT, then G has decidable **WP** (Jeandel, 2015).
- ▶ If G has at least two ends, then it has no strongly aperiodic SFTs (Cohen, 2015)

- ▶ If G is r.p. with a strongly aperiodic SFT, then G has decidable **WP** (Jeandel, 2015).
- ▶ If G has at least two ends, then it has no strongly aperiodic SFTs (Cohen, 2015)
- ▶ Generalization of Kari's construction to some $G \times \mathbb{Z}$ (Jeandel, 2015).

- ▶ If G is r.p. with a strongly aperiodic SFT, then G has decidable **WP** (Jeandel, 2015).
- ▶ If G has at least two ends, then it has no strongly aperiodic SFTs (Cohen, 2015)
- ▶ Generalization of Kari's construction to some $G \times \mathbb{Z}$ (Jeandel, 2015).
- ▶ Discrete Heisenberg group (Sahin, Schraudner & Ugarcovici, 2015).

- ▶ If G is r.p. with a strongly aperiodic SFT, then G has decidable **WP** (Jeandel, 2015).
- ▶ If G has at least two ends, then it has no strongly aperiodic SFTs (Cohen, 2015)
- ▶ Generalization of Kari's construction to some $G \times \mathbb{Z}$ (Jeandel, 2015).
- ▶ Discrete Heisenberg group (Sahin, Schraudner & Ugarcovici, 2015).
- ▶ Surface groups (Cohen & Goodman-Strauss, 2015).

- ▶ If G is r.p. with a strongly aperiodic SFT, then G has decidable **WP** (Jeandel, 2015).
- ▶ If G has at least two ends, then it has no strongly aperiodic SFTs (Cohen, 2015)
- ▶ Generalization of Kari's construction to some $G \times \mathbb{Z}$ (Jeandel, 2015).
- ▶ Discrete Heisenberg group (Sahin, Schraudner & Ugarcovici, 2015).
- ▶ Surface groups (Cohen & Goodman-Strauss, 2015).
- ▶ groups $\mathbb{Z}^2 \rtimes H$ where H has decidable **WP** (B & Sablik, 2016).

Simulation Theorems

What is a simulation theorem?

Finitely presented group

A group G is finitely presented if it can be described as $G = \langle S | R \rangle$ where both S and $R \subset (S \cup S^{-1})^*$ are finite.

$$\mathbb{Z}^2 = \langle a, b \mid aba^{-1}b^{-1} \rangle$$

What is a simulation theorem?

Finitely presented group

A group G is finitely presented if it can be described as $G = \langle S | R \rangle$ where both S and $R \subset (S \cup S^{-1})^*$ are finite.

$$\mathbb{Z}^2 = \langle a, b \mid aba^{-1}b^{-1} \rangle$$

Recursively presented group

A group G is recursively presented if it can be described as $G = \langle S | R \rangle$ where $S \subset \mathbb{N}$ and $R \subset (S \cup S^{-1})^*$ are recursive sets.

$$L = \langle a, t \mid (at^n at^{-n})^2, n \in \mathbb{N} \rangle$$

What is a simulation theorem?

Theorem (Highman 1961)

For every recursively presented group H there exists a finitely presented group G such that H is isomorphic to a subgroup of G .

What is a simulation theorem?

Theorem (Highman 1961)

For every recursively presented group H there exists a finitely presented group G such that H is isomorphic to a subgroup of G .

“A complicated object is realized inside another object which admits a much simpler presentation.”

What is a simulation theorem?

Theorem (Highman 1961)

For every recursively presented group H there exists a finitely presented group G such that H is isomorphic to a subgroup of G .

“A complicated object is realized inside another object which admits a much simpler presentation.”

Corollary [Theorem: Novikov 1955, Boone 1958]

There are finitely presented groups with undecidable word problem

Apply Highman's theorem to

$$G = \langle a, b, c, d \mid b^{-n}ab^n = c^{-n}dc^n, n \in \text{HALT} \rangle.$$

A dynamical simulation theorem

Effectively closed dynamical system

An action $T : \mathbb{Z} \curvearrowright \{0, 1\}^{\mathbb{N}}$ is *effectively closed* if there exists a Turing machine which on entry $w \in \{0, 1\}^*$ enumerates a language L such that:

$$T([w]) = \{0, 1\}^{\mathbb{N}} \setminus \bigcup_{u \in L} [u].$$

A dynamical simulation theorem

Effectively closed dynamical system

An action $T : \mathbb{Z} \curvearrowright \{0, 1\}^{\mathbb{N}}$ is *effectively closed* if there exists a Turing machine which on entry $w \in \{0, 1\}^*$ enumerates a language L such that:

$$T([w]) = \{0, 1\}^{\mathbb{N}} \setminus \bigcup_{u \in L} [u].$$

Theorem (Hochman, 2009)

Let $T : \mathbb{Z} \curvearrowright \{0, 1\}^{\mathbb{N}}$ be an effectively closed action. There exists a \mathbb{Z}^3 -SFT such that its \mathbb{Z} -subaction is an almost 1-1 extension (very close) of T .

The case of subshifts

sofic subshift

A subshift is called *sofic* if it is the image of an SFT by a local recoding.

Effectively closed subshift

A \mathbb{Z} -subshift is *effectively closed* if it can be described by a recursively enumerable set of forbidden words.

The case of subshifts

sofic subshift

A subshift is called *sofic* if it is the image of an SFT by a local recoding.

Effectively closed subshift

A \mathbb{Z} -subshift is *effectively closed* if it can be described by a recursively enumerable set of forbidden words.

Theorem (Aubrun-Sablik, Durand-Romaschenko-Shen 2010)

For effectively closed \mathbb{Z} -subshift X there exists a \mathbb{Z}^2 -sofic subshift Y such that every $y \in Y$ is a periodic vertical extension of a configuration $x \in X$.

The case of subshifts

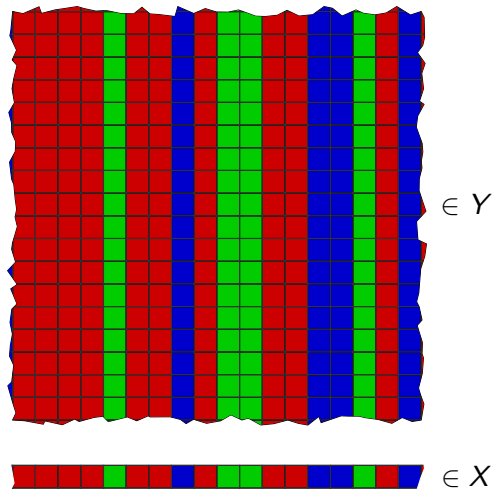

So... why is simulation important?

It is complicated to come up with \mathbb{Z}^2 -SFTs which are strongly aperiodic, however, finding a \mathbb{Z} -effectively closed subshift which is aperiodic is easy.

So... why is simulation important?

It is complicated to come up with \mathbb{Z}^2 -SFTs which are strongly aperiodic, however, finding a \mathbb{Z} -effectively closed subshift which is aperiodic is easy.

Example

Let x be a fixed point of the Thue-Morse substitution.

$$0 \rightarrow 01 \rightarrow 0110 \rightarrow 01101001 \rightarrow 0110100110010110 \rightarrow \dots$$

Then $X = \overline{\text{Orb}_\sigma(x)}$ is strongly aperiodic and effectively closed.

So... why is simulation important?

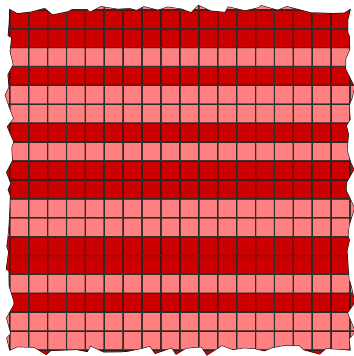
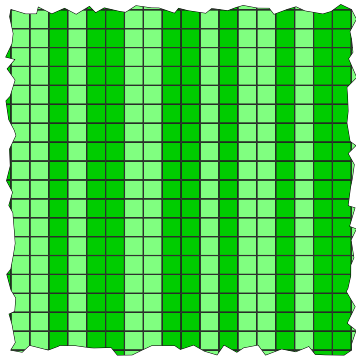

So... why is simulation important?

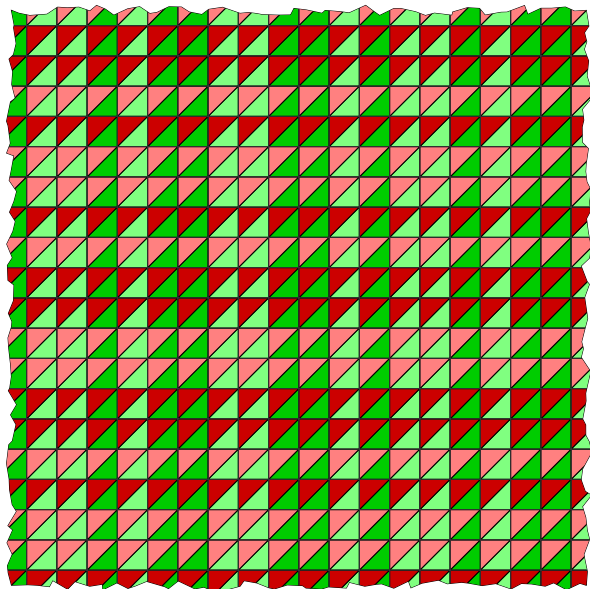

Examples

- ▶ Easy construction of strongly aperiodic \mathbb{Z}^2 -SFTs

Examples

- ▶ Easy construction of strongly aperiodic \mathbb{Z}^2 -SFTs
- ▶ \mathbb{Z}^2 -SFTs with no computable configurations (Original result by Hanf-Myers 1974)

So... why is simulation important?

Examples

- ▶ Easy construction of strongly aperiodic \mathbb{Z}^2 -SFTs
- ▶ \mathbb{Z}^2 -SFTs with no computable configurations (Original result by Hanf-Myers 1974)
- ▶ Classifying the entropies of \mathbb{Z}^2 -SFTs (Original result by Hochman-Meyerovitch 2010)

Two new results in general groups

Let $T : G \curvearrowright \{0, 1\}^{\mathbb{N}}$ be an effectively closed action of a finitely generated group.

Theorem (B-Sablik, 2016)

For any semidirect product $\mathbb{Z}^2 \rtimes G$ there exists a $\mathbb{Z}^2 \rtimes G$ -SFT such that its G -subaction is an extension of T .

Two new results in general groups

Let $T : G \curvearrowright \{0, 1\}^{\mathbb{N}}$ be an effectively closed action of a finitely generated group.

Theorem (B-Sablik, 2016)

For any semidirect product $\mathbb{Z}^2 \rtimes G$ there exists a $\mathbb{Z}^2 \rtimes G$ -SFT such that its G -subaction is an extension of T .

Theorem (B, 2017)

For any pair of infinite and finitely generated groups H_1, H_2 there exists a $(G \times H_1 \times H_2)$ -SFT such that its G -subaction is an extension of T .

How does one prove such a thing?

Let's keep it simple, let's do $G \times \mathbb{Z}^2$.

How does one prove such a thing?

Let's keep it simple, let's do $G \times \mathbb{Z}^2$. Consider

$\Psi : \{0, 1\}^{\mathbb{N}} \rightarrow \{0, 1, \$\}^{\mathbb{Z}}$ given by:

$$\Psi(x)_j = \begin{cases} x_n & \text{if } j = 3^n \pmod{3^{n+1}} \\ \$ & \text{in the contrary case.} \end{cases}$$

How does one prove such a thing?

Let's keep it simple, let's do $G \times \mathbb{Z}^2$. Consider

$\Psi : \{0, 1\}^{\mathbb{N}} \rightarrow \{0, 1, \$\}^{\mathbb{Z}}$ given by:

$$\Psi(x)_j = \begin{cases} x_n & \text{if } j = 3^n \pmod{3^{n+1}} \\ \$ & \text{in the contrary case.} \end{cases}$$

Example

If we write $x = x_0x_1x_2x_3 \dots$ we obtain,

$$\Psi(x) = \dots \$x_0\$x_1x_0\$ \$x_0\$x_2x_0\$x_1x_0\$ \$x_0\$ \$x_0\$x_1x_0\$ \$x_0\$x_3x_0 \dots$$

How does one prove such a thing?

... $x_0 x_1 x_0 x_0 x_2 x_0 x_1 x_0 x_0 x_0 x_1 x_0 x_0 x_3 x_0$...

How does one prove such a thing?

... $x_0 x_1 x_0 x_0 x_2 x_0 x_1 x_0 x_0 x_0 x_1 x_0 x_0 x_3 x_0$...



... $x_0 x_1 x_0 x_0 x_2 x_0 x_1 x_0 x_0 x_0 x_1 x_0 x_0 x_3 x_0$...

How does one prove such a thing?

... $x_0 x_1 x_0 x_0 x_2 x_0 x_1 x_0 x_0 x_0 x_1 x_0 x_0 x_3 x_0$...

↓

... $x_0 x_1 x_0 x_0 x_2 x_0 x_1 x_0 x_0 x_0 x_1 x_0 x_0 x_3 x_0$...

↓

... $x_0 x_1 x_0 x_2 x_1 x_0 x_0 x_1 x_0 x_3$...

How does one prove such a thing?

... $x_0 x_1 x_0 x_0 x_2 x_0 x_1 x_0 x_0 x_0 x_1 x_0 x_0 x_3 x_0$...

↓

... $x_0 x_1 x_0 x_0 x_2 x_0 x_1 x_0 x_0 x_0 x_1 x_0 x_0 x_3 x_0$...

↓

... $x_1 x_2 x_1 x_0 x_1 x_0 x_1 x_3$...

↓

... $x_1 x_2 x_1 x_3 x_1 x_2 x_1 x_1 x_2 x_1 x_4 x_1$...

How does one prove such a thing?

- ▷ pick a finite set of generators S of G .
- ▷ construct a subshift Π where every configuration is (up to shifts and a set of measure 0) an S -tuple of configurations of the previous form.

$$S = \{1_G, s_1, \dots, s_n\}$$

$$(\Psi(x), \Psi(T^{s_1}(x)), \dots, \Psi(T^{s_n}(x))) \in \Pi$$

How does one prove such a thing?

- ▷ pick a finite set of generators S of G .
- ▷ construct a subshift Π where every configuration is (up to shifts and a set of measure 0) an S -tuple of configurations of the previous form.

$$S = \{1_G, s_1, \dots, s_n\}$$

$$(\Psi(x), \Psi(T^{s_1}(x)), \dots, \Psi(T^{s_n}(x))) \in \Pi$$

Claim

If T is an effectively closed action, Π is effectively closed.

How does one prove such a thing?

- ▷ Take Π and construct a sofic \mathbb{Z}^2 subshift $\tilde{\Pi}$ having Π in every horizontal row.

How does one prove such a thing?

- ▷ Take Π and construct a sofic \mathbb{Z}^2 subshift $\tilde{\Pi}$ having Π in every horizontal row.
- ▷ Using the decoding argument, construct a map from Π to X .

How does one prove such a thing?

- ▷ Take Π and construct a sofic \mathbb{Z}^2 subshift $\tilde{\Pi}$ having Π in every horizontal row.
- ▷ Using the decoding argument, construct a map from Π to X .
- ▷ Put in every G -coset of $G \times \mathbb{Z}^2$ a configuration of $\tilde{\Pi}$.

How does one prove such a thing?

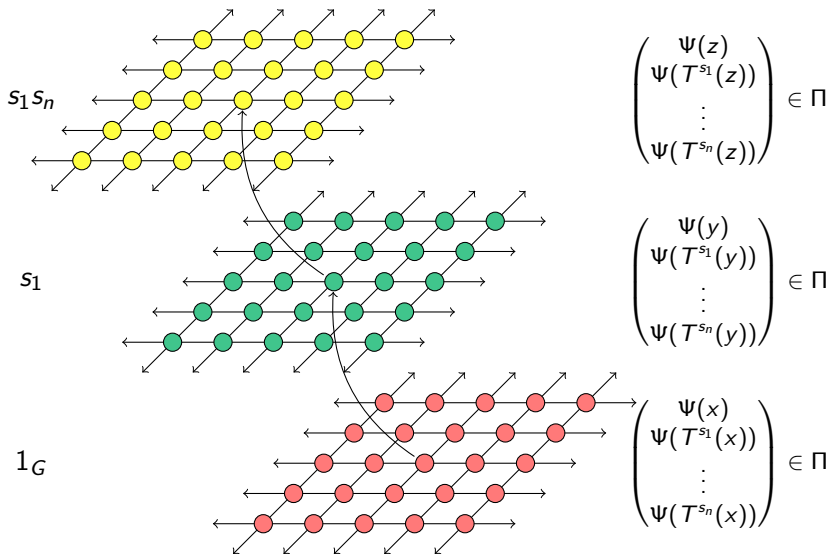

How does one prove such a thing?

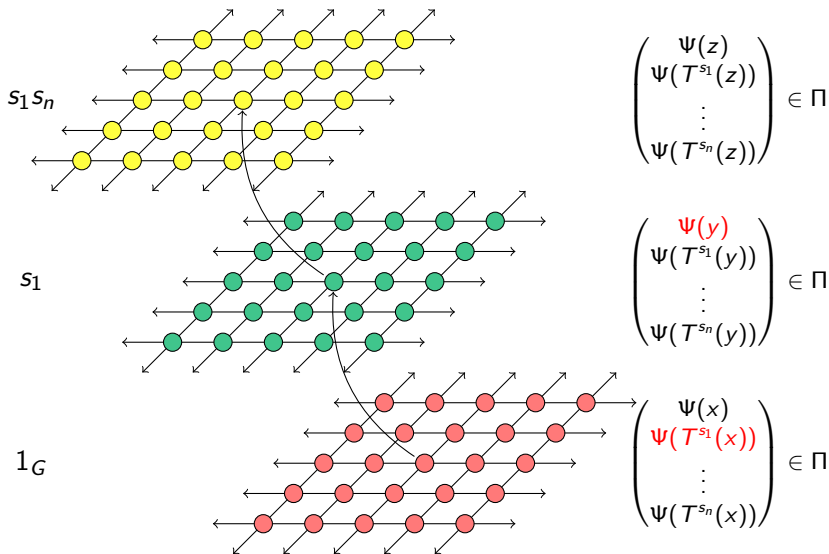

How does one prove such a thing?

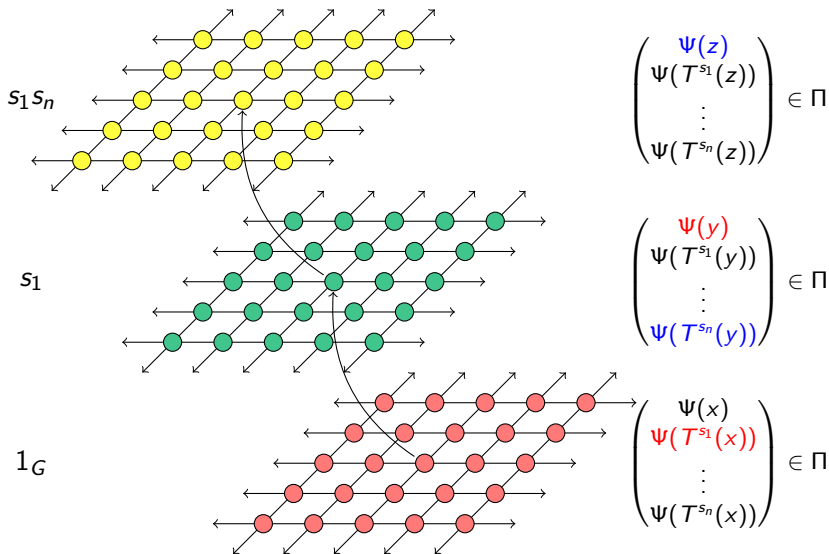

How does one prove such a thing?

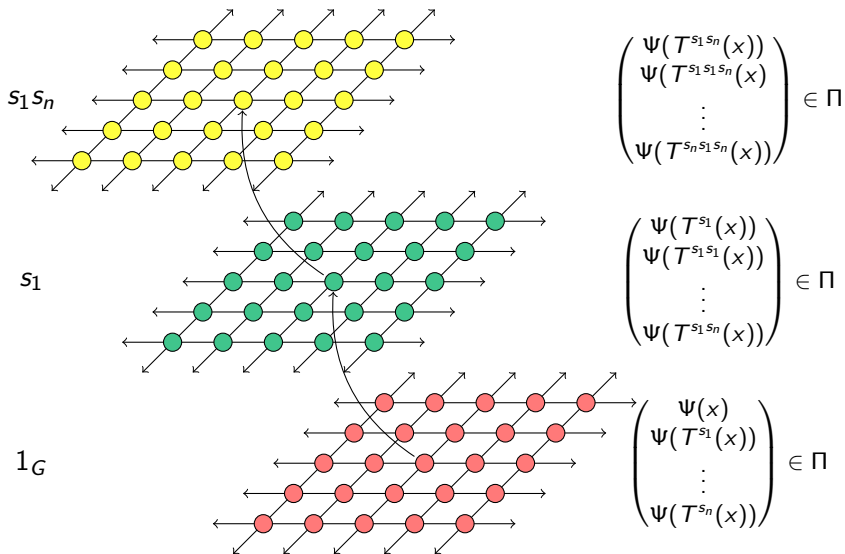

Theorem (B, Sablik 2016)

If G is finitely generated, $WP(G)$ is decidable and $d > 1$. Then $G \times \mathbb{Z}^d$ admits a SA SFT.

Theorem (B, Sablik 2016)

If G is finitely generated, $WP(G)$ is decidable and $d > 1$. Then $G \times \mathbb{Z}^d$ admits a SA SFT.

Theorem (B 2017)

If G_i are at least three infinite and finitely generated groups with decidable word problem. Then $G_1 \times \cdots \times G_n$ admits a SA SFT.

What about the Grigorchuk group?

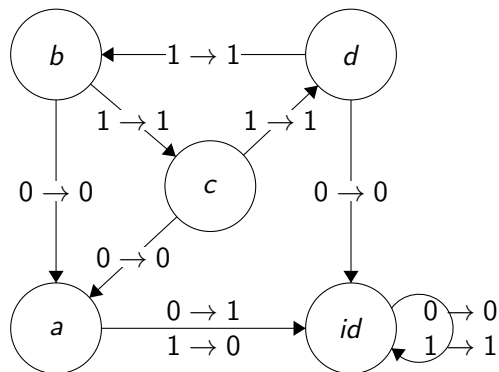

The Grigorchuk group is generated by the actions a, b, c, d over $\{0, 1\}^{\mathbb{N}}$.

What about the Grigorchuk group?

- The Grigorchuk group is infinite and finitely generated.
- It contains no copy of \mathbb{Z} as a subgroup. For every $g \in G$, there is $n \in \mathbb{N}$ such that $g^n = 1_G$.
- Decidable word problem (and conjugacy problem).
- It has intermediate growth.
- It is commensurable to its square. ie: G and $G \times G$ have an isomorphic finite index subgroup.

What about the Grigorchuk group?

▷ If G is commensurable to $G \times G$, then G is also commensurable to $G \times G \times G$.

What about the Grigorchuk group?

▷ If G is commensurable to $G \times G$, then G is also commensurable to $G \times G \times G$.

Theorem (Carroll-Penland, 2015)

Admitting a strongly aperiodic SFT is a commensurability invariant.

What about the Grigorchuk group?

▷ If G is commensurable to $G \times G$, then G is also commensurable to $G \times G \times G$.

Theorem (Carroll-Penland, 2015)

Admitting a strongly aperiodic SFT is a commensurability invariant.

Theorem (B, 2017)

The Grigorchuk group admits a strongly aperiodic SFT.

Thank you for your attention!

