

Self-simulable groups

Sebastián **Barbieri Lemp**

Joint work with Mathieu **Sablik** and Ville **Salo**

Universidad de Santiago de Chile

Séminaire Teich

April, 2021

- ▷ Finitely presented group.

$$\Gamma = \langle s_1, \dots, s_n \mid r_1, \dots, r_k \rangle.$$

- ▷ Finitely presented group.

$$\Gamma = \langle s_1, \dots, s_n \mid r_1, \dots, r_k \rangle.$$

- ▷ Finitely generated recursively presented group.

$$\Gamma = \langle s_1, \dots, s_n \mid (r_i)_{i \in \mathbb{N}} \rangle.$$

Where the sequence $(r_i)_{i \in \mathbb{N}}$ can be enumerated by a Turing machine.

- ▷ Finitely presented group.

$$\Gamma = \langle s_1, \dots, s_n \mid r_1, \dots, r_k \rangle.$$

- ▷ Finitely generated recursively presented group.

$$\Gamma = \langle s_1, \dots, s_n \mid (r_i)_{i \in \mathbb{N}} \rangle.$$

Where the sequence $(r_i)_{i \in \mathbb{N}}$ can be enumerated by a Turing machine.

Theorem (Higman 1961)

Every (finitely generated) recursively presented group occurs as a subgroup of a finitely presented group.

- ▷ Topological dynamics.

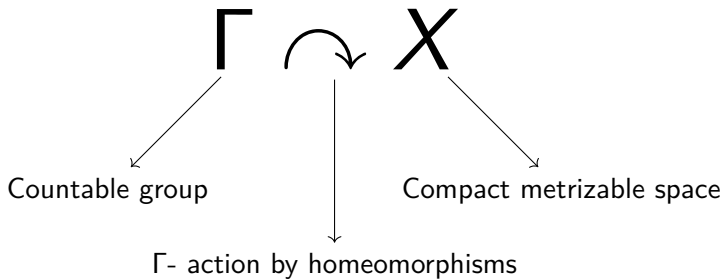

What would a dynamical analogue of Higman's theorem look like?

What would a dynamical analogue of Higman's theorem look like?

Finitely presented group



- Subshift of finite type

Recursively presented group



- X can be described by a Turing machine.
- The action $\Gamma \curvearrowright X$ can be described by a Turing machine.

What would a dynamical analogue of Higman's theorem look like?

Finitely presented group



- Subshift of finite type

Recursively presented group



- X can be described by a Turing machine.
- The action $\Gamma \curvearrowright X$ can be described by a Turing machine.

▷ We want something like: “every action which can be described by a Turing machine is the topological factor of a subshift of finite type.”

Subshift of finite type

Let A be a finite set and consider $A^\Gamma = \{x: \Gamma \rightarrow A\}$ with the prodiscrete topology and the action $\Gamma \curvearrowright A^\Gamma$ given by

$$(gx)(h) = x(g^{-1}h) \text{ for every } g, h \in \Gamma.$$

Subshift of finite type

Let A be a finite set and consider $A^\Gamma = \{x: \Gamma \rightarrow A\}$ with the prodiscrete topology and the action $\Gamma \curvearrowright A^\Gamma$ given by

$$(gx)(h) = x(g^{-1}h) \text{ for every } g, h \in \Gamma.$$

A subset $X \subseteq A^\Gamma$ is called a Γ -**subshift** if it is closed and Γ -invariant.

Subshift of finite type

Let A be a finite set and consider $A^\Gamma = \{x: \Gamma \rightarrow A\}$ with the prodiscrete topology and the action $\Gamma \curvearrowright A^\Gamma$ given by

$$(gx)(h) = x(g^{-1}h) \text{ for every } g, h \in \Gamma.$$

A subset $X \subseteq A^\Gamma$ is called a Γ -**subshift** if it is closed and Γ -invariant.

Subshift of finite type

A set $Z \subseteq A^\Gamma$ is a Γ -**subshift of finite type** (SFT) if there is a finite set $F \subseteq \Gamma$ and $\mathcal{F} \subseteq A^F$ such that $z \in Z$ if and only if

$$(gz)|_F \notin \mathcal{F} \text{ for every } g \in \Gamma.$$

A subshift is of finite type if it is the set of configurations $x \in A^\Gamma$ which avoid a finite list of forbidden patterns (represented by \mathcal{F}).

Hard-square shift. $Z = \{x : \mathbb{Z}^2 \rightarrow \{0, 1\}\}$ such that there are no vertical or horizontally adjacent 1s.

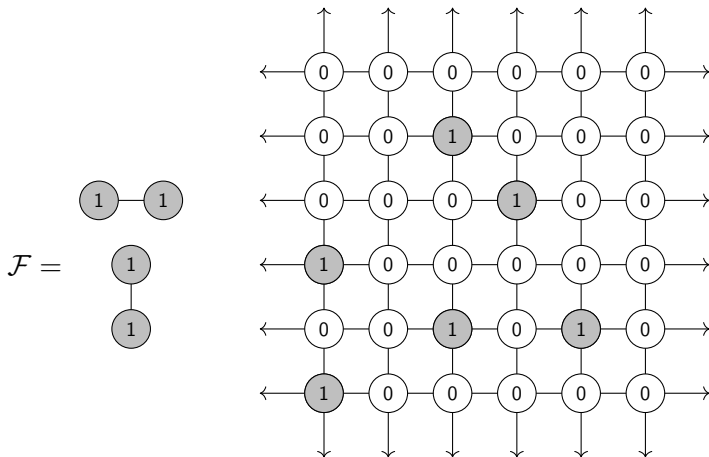

Hard-square in F_2 .

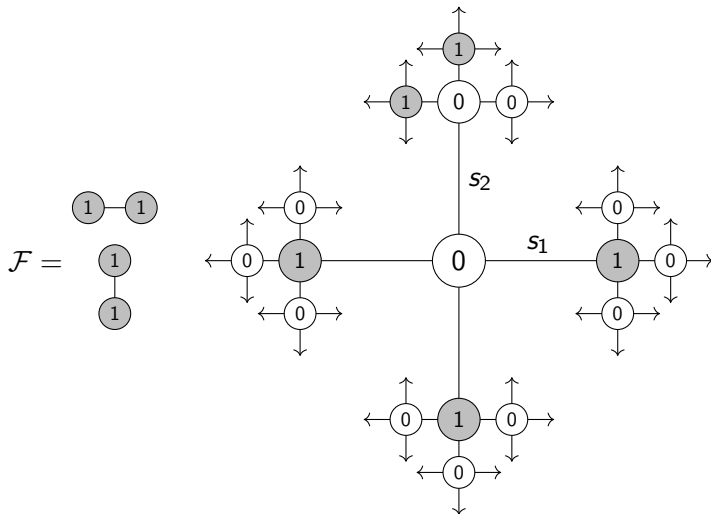

X can be described by a Turing machine

For a word $w = w_0 w_1 \dots w_{n-1} \in \{0, 1\}^n$ consider the cylinder set

$$[w] = \{x \in \{0, 1\}^{\mathbb{N}} : x|_{\{0, \dots, n-1\}} = w\}.$$

Effectively closed set

A set $X \subseteq \{0, 1\}^{\mathbb{N}}$ is called **effectively closed** if it is closed and there is a Turing machine which enumerates a sequence of words $(w_n)_{n \in \mathbb{N}}$ such that

$$X = \{0, 1\}^{\mathbb{N}} \setminus \bigcup_{n \in \mathbb{N}} [w_n].$$

$\Gamma \curvearrowright X$ can be described by a Turing machine

Let Γ be finitely generated by a symmetric set $S \ni 1_\Gamma$ and $X \subseteq \{0, 1\}^{\mathbb{N}}$. Given $\Gamma \curvearrowright X$ consider the set

$$Y = \{y \in (\{0, 1\}^S)^{\mathbb{N}} : \pi_s(y) = s \cdot \pi_{1_\Gamma}(y) \in X \text{ for every } s \in S\}.$$

Where $\pi_s(y) \in \{0, 1\}^{\mathbb{N}}$ is such that $\pi_s(y)(n) = y(n)(s)$.

$\Gamma \curvearrowright X$ can be described by a Turing machine

Let Γ be finitely generated by a symmetric set $S \ni 1_\Gamma$ and $X \subseteq \{0, 1\}^{\mathbb{N}}$. Given $\Gamma \curvearrowright X$ consider the set

$$Y = \{y \in (\{0, 1\}^S)^{\mathbb{N}} : \pi_s(y) = s \cdot \pi_{1_\Gamma}(y) \in X \text{ for every } s \in S\}.$$

Where $\pi_s(y) \in \{0, 1\}^{\mathbb{N}}$ is such that $\pi_s(y)(n) = y(n)(s)$.

Effectively closed action

An action $\Gamma \curvearrowright X \subseteq \{0, 1\}^{\mathbb{N}}$ is effectively closed if Y is an effectively closed set.

Intuitively: there is an algorithm telling me (1) when $x \notin X$ and (2) when $x \neq s \cdot y$.

$\Gamma \curvearrowright X$ can be described by a Turing machine

Let Γ be finitely generated by a symmetric set $S \ni 1_\Gamma$ and $X \subseteq \{0, 1\}^{\mathbb{N}}$. Given $\Gamma \curvearrowright X$ consider the set

$$Y = \{y \in (\{0, 1\}^S)^{\mathbb{N}} : \pi_s(y) = s \cdot \pi_{1_\Gamma}(y) \in X \text{ for every } s \in S\}.$$

Where $\pi_s(y) \in \{0, 1\}^{\mathbb{N}}$ is such that $\pi_s(y)(n) = y(n)(s)$.

Effectively closed action

An action $\Gamma \curvearrowright X \subseteq \{0, 1\}^{\mathbb{N}}$ is effectively closed if Y is an effectively closed set.

Intuitively: there is an algorithm telling me (1) when $x \notin X$ and (2) when $x \neq s \cdot y$.

Note: In this talk we will always suppose that Γ has decidable word problem to avoid certain technicalities.



Odometer

$\mathbb{Z} \curvearrowright (\mathbb{Z}/2\mathbb{Z})^{\mathbb{N}}$ given by $x \mapsto x + 1$ in binary.

Odometer

$\mathbb{Z} \curvearrowright (\mathbb{Z}/2\mathbb{Z})^{\mathbb{N}}$ given by $x \mapsto x + 1$ in binary.

Subshifts of finite type

SFTs are topologically conjugate to effectively closed actions.

Odometer

$\mathbb{Z} \curvearrowright (\mathbb{Z}/2\mathbb{Z})^{\mathbb{N}}$ given by $x \mapsto x + 1$ in binary.

Subshifts of finite type

SFTs are topologically conjugate to effectively closed actions.

Topological factors

Topological factors of effectively closed actions are effectively closed.

Recall that $\Gamma \curvearrowright Y$ is a topological factor of $\Gamma \curvearrowright X$ if there exists a continuous surjective map $\phi: X \rightarrow Y$ which is Γ -equivariant ($g\phi(x) = \phi(gx)$ for every $g \in \Gamma, x, y \in X$).

Examples

Consider $X = \{0, 1\}^{\mathbb{N}}$ and let u_1, \dots, u_n and v_1, \dots, v_n be non-empty words in $\{0, 1\}^*$ such that

$$X = [u_1] \sqcup [u_2] \sqcup \dots \sqcup [u_n] = [v_1] \sqcup [v_2] \sqcup \dots \sqcup [v_n].$$

Let φ be the homeomorphism of $\{0, 1\}^{\mathbb{N}}$ which maps every cylinder $[u_i]$ to $[v_i]$ by replacing prefixes, that is

$$\varphi(u_i x) = v_i x \text{ for every } x \in \{0, 1\}^{\mathbb{N}}.$$

Examples

Consider $X = \{0, 1\}^{\mathbb{N}}$ and let u_1, \dots, u_n and v_1, \dots, v_n be non-empty words in $\{0, 1\}^*$ such that

$$X = [u_1] \sqcup [u_2] \sqcup \dots \sqcup [u_n] = [v_1] \sqcup [v_2] \sqcup \dots \sqcup [v_n].$$

Let φ be the homeomorphism of $\{0, 1\}^{\mathbb{N}}$ which maps every cylinder $[u_i]$ to $[v_i]$ by replacing prefixes, that is

$$\varphi(u_i x) = v_i x \text{ for every } x \in \{0, 1\}^{\mathbb{N}}.$$

$u_1 = 00, u_2 = 01, u_3 = 1$ and $v_1 = 0, v_2 = 10, v_3 = 11$.

$$\varphi(0101010\dots) = 1001010\dots \quad \varphi(0000000\dots) = 0000000\dots$$

$$\varphi(1111111\dots) = 1111111\dots \quad \varphi(0011001\dots) = 011001\dots$$

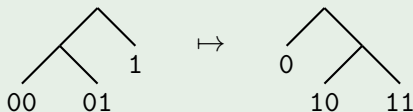



Natural action of Thompson's groups

- F is the group of all such homeomorphisms where u_1, \dots, u_n and v_1, \dots, v_n are given in lexicographical order.
- T is the group of all such homeomorphisms where u_1, \dots, u_n and v_1, \dots, v_n are given in lexicographical order up to a cyclic permutation.
- V is the group of all such homeomorphisms.



Natural action of Thompson's groups

- F is the group of all such homeomorphisms where u_1, \dots, u_n and v_1, \dots, v_n are given in lexicographical order.
- T is the group of all such homeomorphisms where u_1, \dots, u_n and v_1, \dots, v_n are given in lexicographical order up to a cyclic permutation.
- V is the group of all such homeomorphisms.

Then $F \leq T \leq V$ are the Thompson's groups.



Natural action of Thompson's groups

- F is the group of all such homeomorphisms where u_1, \dots, u_n and v_1, \dots, v_n are given in lexicographical order.
- T is the group of all such homeomorphisms where u_1, \dots, u_n and v_1, \dots, v_n are given in lexicographical order up to a cyclic permutation.
- V is the group of all such homeomorphisms.

Then $F \leq T \leq V$ are the Thompson's groups.

▷ these groups are finitely presented and have decidable word problem.



Natural action of Thompson's groups

- F is the group of all such homeomorphisms where u_1, \dots, u_n and v_1, \dots, v_n are given in lexicographical order.
- T is the group of all such homeomorphisms where u_1, \dots, u_n and v_1, \dots, v_n are given in lexicographical order up to a cyclic permutation.
- V is the group of all such homeomorphisms.

Then $F \leq T \leq V$ are the Thompson's groups.

▷ these groups are finitely presented and have decidable word problem.

Their natural action on $\{0, 1\}^{\mathbb{N}}$ is effectively closed.

What results are known?

Hochman's theorem, 2009

Every effectively closed action $\mathbb{Z} \curvearrowright X$ is the topological factor of a subaction of a \mathbb{Z}^3 -subshift of finite type Z .

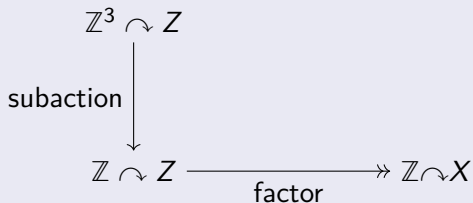

What results are known?

Hochman's theorem, 2009

Every effectively closed action $\mathbb{Z} \curvearrowright X$ is the topological factor of a subaction of a \mathbb{Z}^3 -subshift of finite type Z .

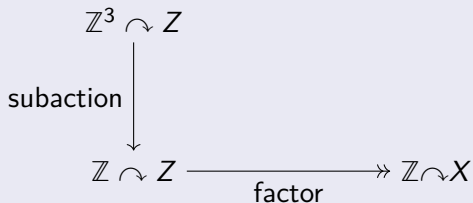

Moreover, the factor is nice (mod a group rotation, 1-1 in a set of full measure with respect to any invariant measure.)

Hochman's theorem, 2009

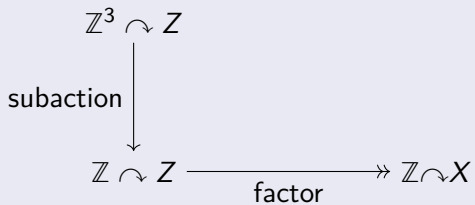

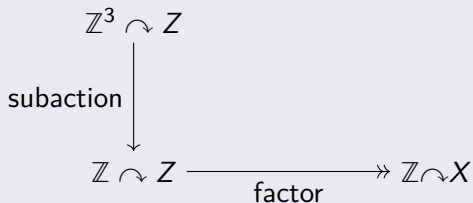

▷ The dimension is optimal: there are effectively closed \mathbb{Z} -actions that cannot be obtained from \mathbb{Z}^2 -SFTs.

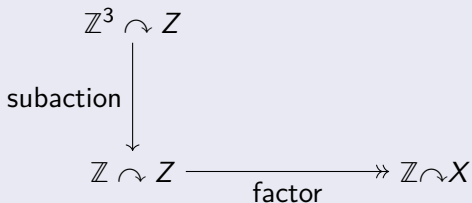

▷ The dimension is optimal: there are effectively closed \mathbb{Z} -actions that cannot be obtained from \mathbb{Z}^2 -SFTs.

(unless the \mathbb{Z} -effectively closed action is **expansive**)

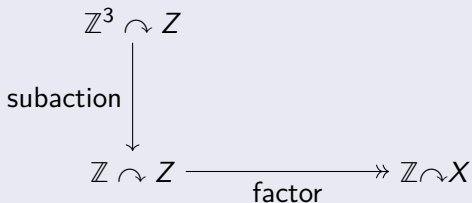

▷ The dimension is optimal: there are effectively closed \mathbb{Z} -actions that cannot be obtained from \mathbb{Z}^2 -SFTs.

(unless the \mathbb{Z} -effectively closed action is **expansive**)

An action $\Gamma \curvearrowright X$ on a metric space is expansive if there is $C > 0$ such that whenever $d(gx, gy) \leq C$ for every $g \in \Gamma$ then $x = y$.

expansive + zero-dimensional \iff subshift.

Every effectively closed expansive action $\mathbb{Z} \curvearrowright X$ is topologically conjugate to the \mathbb{Z} -subaction of a symbolic factor of a \mathbb{Z}^2 -SFT Z .

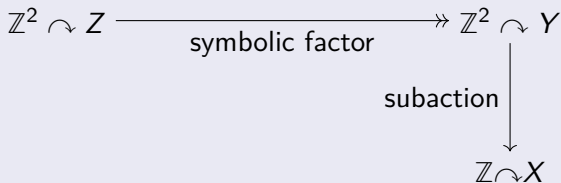

Every effectively closed expansive action $\mathbb{Z} \curvearrowright X$ is topologically conjugate to the \mathbb{Z} -subaction of a symbolic factor of a \mathbb{Z}^2 -SFT Z .

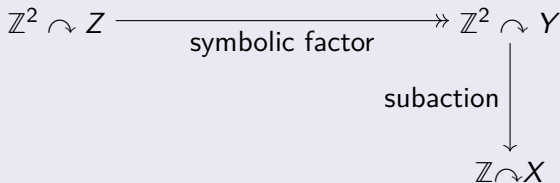

Many classical results are easy corollaries from this:

Every effectively closed expansive action $\mathbb{Z} \curvearrowright X$ is topologically conjugate to the \mathbb{Z} -subaction of a symbolic factor of a \mathbb{Z}^2 -SFT Z .

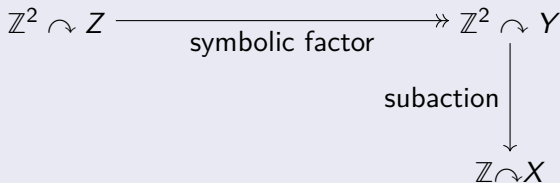

Many classical results are easy corollaries from this:

- Existence of \mathbb{Z}^2 -SFTs where the action is free (Berger, Robinson)

Every effectively closed expansive action $\mathbb{Z} \curvearrowright X$ is topologically conjugate to the \mathbb{Z} -subaction of a symbolic factor of a \mathbb{Z}^2 -SFT Z .

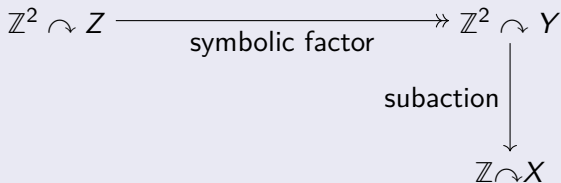

Many classical results are easy corollaries from this:

- Existence of \mathbb{Z}^2 -SFTs where the action is free (Berger, Robinson)
- Undecidability of whether a \mathbb{Z}^2 -SFT X given by a finite list of forbidden patterns is empty (Berger)

Every effectively closed expansive action $\mathbb{Z} \curvearrowright X$ is topologically conjugate to the \mathbb{Z} -subaction of a symbolic factor of a \mathbb{Z}^2 -SFT Z .

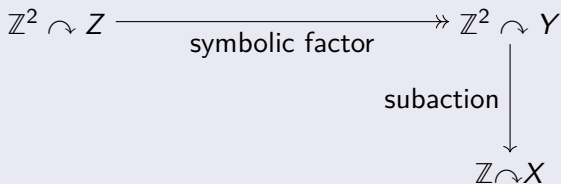

Many classical results are easy corollaries from this:

- Existence of \mathbb{Z}^2 -SFTs where the action is free (Berger, Robinson)
- Undecidability of whether a \mathbb{Z}^2 -SFT X given by a finite list of forbidden patterns is empty (Berger)
- Characterization of the topological entropies of \mathbb{Z}^2 -SFTs (Hochman-Meyerovitch).

B. Sablik, 2019

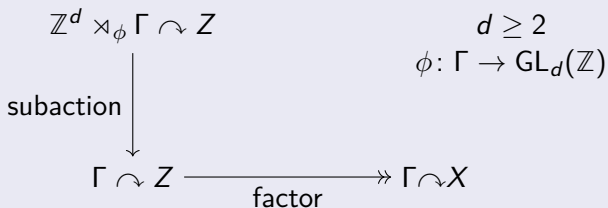

Similar results for actions of groups

B. Sablik, 2019



B, 2019

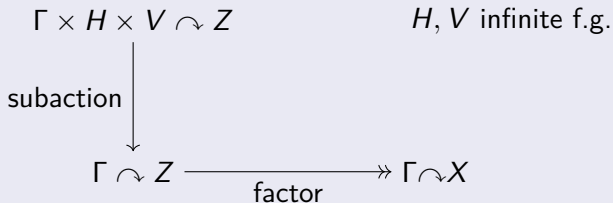

Are there any groups Γ such that the diagram is as simple as possible?

🐏 Holy grail 🐏

$$\Gamma \curvearrowright Z \xrightarrow{\text{factor}} \Gamma \curvearrowright X$$

In words: are there finitely generated groups Γ such that every effectively closed action $\Gamma \curvearrowright X$ is the factor of a Γ -SFT Z ?

Are there any groups Γ such that the diagram is as simple as possible?

🐐 Holy grail 🐐

$$\Gamma \curvearrowright Z \xrightarrow{\text{factor}} \Gamma \curvearrowright X$$

In words: are there finitely generated groups Γ such that every effectively closed action $\Gamma \curvearrowright X$ is the factor of a Γ -SFT Z ?

Theorem (B., Sablik, Salo 2021)

Yes.

Why is the question crazy?

Self-simulable group

A finitely generated group Γ is **self-simulable** if every effectively closed action $\Gamma \curvearrowright X$ is the factor of a Γ -SFT Z

Why is the question crazy?

Self-simulable group

A finitely generated group Γ is **self-simulable** if every effectively closed action $\Gamma \curvearrowright X$ is the factor of a Γ -SFT Z

- ▷ there are a lot of obstructions to self-simulability.
 - Amenable groups cannot be self-simulable (topological entropy is an obstruction).
 - Groups with infinitely many ends cannot be self-simulable.
 - Some one-ended non-amenable groups are not self-simulable (ex: $F_2 \times \mathbb{Z}$).

Theorem (B., Sablik, Salo 2021)

The direct product $\Gamma = \Gamma_1 \times \Gamma_2$ of any pair of non-amenable finitely generated groups is self-simulable.

Theorem (B., Sablik, Salo 2021)

The direct product $\Gamma = \Gamma_1 \times \Gamma_2$ of any pair of non-amenable finitely generated groups is self-simulable.

- No need for self-similar or hierarchical structures as in the other results in the literature.

Theorem (B., Sablik, Salo 2021)

The direct product $\Gamma = \Gamma_1 \times \Gamma_2$ of any pair of non-amenable finitely generated groups is self-simulable.

- No need for self-similar or hierarchical structures as in the other results in the literature.
- Proof based on the existence of paradoxical decompositions.

Theorem (B., Sablik, Salo 2021)

The direct product $\Gamma = \Gamma_1 \times \Gamma_2$ of any pair of non-amenable finitely generated groups is self-simulable.

- No need for self-similar or hierarchical structures as in the other results in the literature.
- Proof based on the existence of paradoxical decompositions.
- The technique is very flexible and allows for many other applications.

Amenable and non-amenable groups

Let Γ be a group and let $K \subseteq \Gamma$ be finite and $\delta > 0$.

▷ we say $F \subseteq \Gamma$ is (K, δ) -invariant if

$$|KF \Delta F| \leq \delta |F|.$$

Amenable and non-amenable groups

Let Γ be a group and let $K \subseteq \Gamma$ be finite and $\delta > 0$.

▷ we say $F \subseteq \Gamma$ is (K, δ) -invariant if

$$|KF \Delta F| \leq \delta |F|.$$

$$\begin{aligned}\Gamma &= \mathbb{Z}^2 \\ K &= \{(1, 1)\} \\ F &= \llbracket -n, n \rrbracket^2\end{aligned}$$

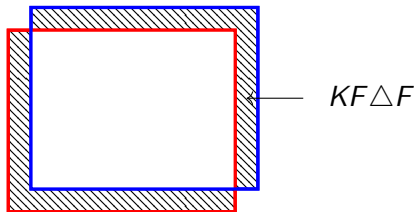

Amenable and non-amenable groups

Let Γ be a group and let $K \subseteq \Gamma$ be finite and $\delta > 0$.

▷ we say $F \subseteq \Gamma$ is (K, δ) -invariant if

$$|KF \Delta F| \leq \delta |F|.$$

$$\begin{aligned}\Gamma &= \mathbb{Z}^2 \\ K &= \{(1, 1)\} \\ F &= \llbracket -n, n \rrbracket^2\end{aligned}$$

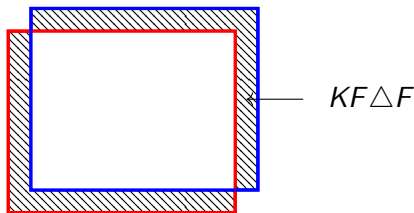

Amenable group

A group Γ is amenable if for every pair (K, δ) there exists a finite $F \subseteq \Gamma$ which is (K, δ) -invariant.

Amenable and non-amenable groups

- ▷ A non-amenable group is a group which is not amenable (duh!)

▷ A non-amenable group is a group which is not amenable (duh!)

Non-amenable group

A group Γ is non-amenable if and only if it admits a **paradoxical decomposition**.

There is a partition $\Gamma = A \sqcup B$ and subpartitions

$$A = \bigsqcup_{i=1}^n A_i, \quad B = \bigsqcup_{j=1}^k B_j,$$

and elements $a_1, \dots, a_n \in \Gamma$, $b_1, \dots, b_k \in \Gamma$ such that

$$\Gamma = \bigsqcup_{i=1}^n a_i A_i = \bigsqcup_{j=1}^k b_j B_j.$$

Example: $F_2 = \langle a, b \rangle$.

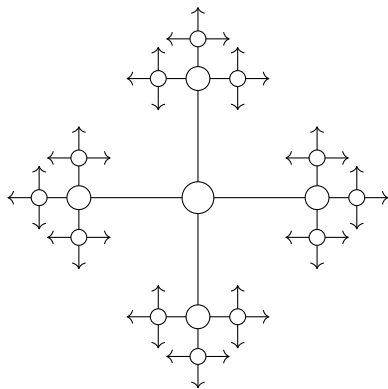

Amenable and non-amenable groups

Example: $F_2 = \langle a, b \rangle$.

$$\begin{aligned}\Gamma &= A \cup B \\ A &= A_1 \cup A_2 \\ B &= B_1 \cup B_2 \cup B_3\end{aligned}$$

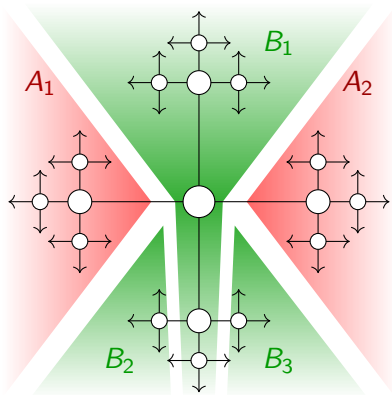

Amenable and non-amenable groups

Example: $F_2 = \langle a, b \rangle$.

$$\Gamma = A \sqcup B$$

$$A = A_1 \sqcup A_2$$

$$B = B_1 \sqcup B_2 \sqcup B_3$$

$$\Gamma = A_1 \sqcup a^{-1}A_2$$

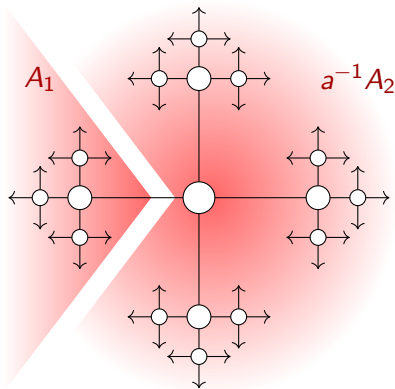

Amenable and non-amenable groups

Example: $F_2 = \langle a, b \rangle$.

$$\begin{aligned}\Gamma &= A \cup B \\ A &= A_1 \cup A_2 \\ B &= B_1 \cup B_2 \cup B_3 \\ \Gamma &= A_1 \sqcup a^{-1}A_2\end{aligned}$$

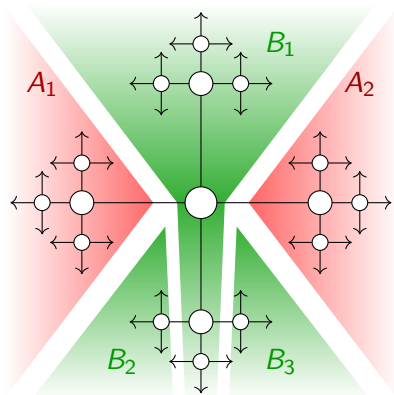

Amenable and non-amenable groups

Example: $F_2 = \langle a, b \rangle$.

$$\Gamma = A \sqcup B$$

$$A = A_1 \sqcup A_2$$

$$B = B_1 \sqcup B_2 \sqcup B_3$$

$$\Gamma = A_1 \sqcup a^{-1}A_2$$

$$\Gamma = b^{-1}B_1 \sqcup B_2 \sqcup B_3$$

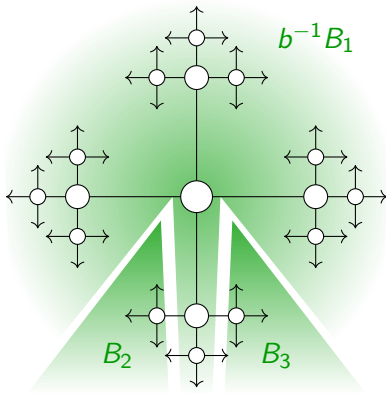

Amenable and non-amenable groups

▷ Paradoxical decompositions can be expressed analytically.

Non-amenable group

A group Γ is non-amenable if and only if there exists a finite set $K \subseteq \Gamma$ and a 2-to-1 map $\varphi: \Gamma \rightarrow \Gamma$ such that

$$g^{-1}\varphi(g) \in K \text{ for every } g \in \Gamma.$$

Amenable and non-amenable groups

▷ Paradoxical decompositions can be expressed analytically.

Non-amenable group

A group Γ is non-amenable if and only if there exists a finite set $K \subseteq \Gamma$ and a 2-to-1 map $\varphi: \Gamma \rightarrow \Gamma$ such that

$$g^{-1}\varphi(g) \in K \text{ for every } g \in \Gamma.$$

▷ The collection of all such maps can be coded using a Γ -subshift of finite type.

$$\mathbf{Alphabet} = K^3 \times \{G, B\}.$$

- Three directions K^3 : one pointing to $\varphi(g)$, the next two pointing to the two preimages
- A color (green or blue) (partitioning the elements of the group into two paradoxical sets).

The paradoxical subshift

In pictures, the alphabet represents the following structure.

$$(k_1, k_2, k_3, G) \in K^3 \times \{G, B\}$$

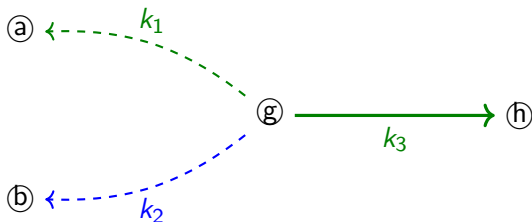

- $a \neq b$,
- $\varphi(a) = ak_1^{-1} = g$,
- $\varphi(b) = bk_2^{-1} = g$,
- $\varphi(g) = gk_3 = h$.

The paradoxical subshift

The local rules of the subshift impose that every node has two preimages of distinct color, and left arrows must match with right arrows.

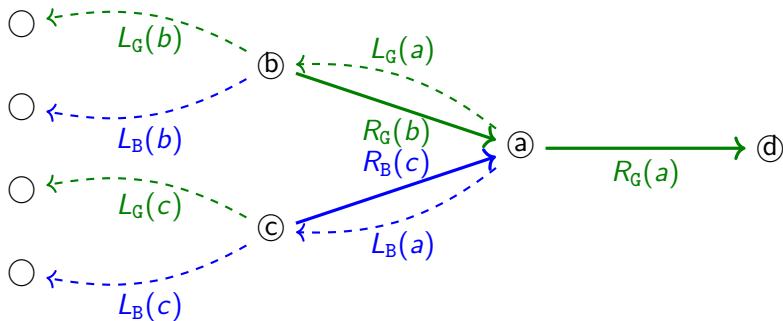

The paradoxical subshift

The local rules of the subshift impose that every node has two preimages of distinct color, and left arrows must match with right arrows.

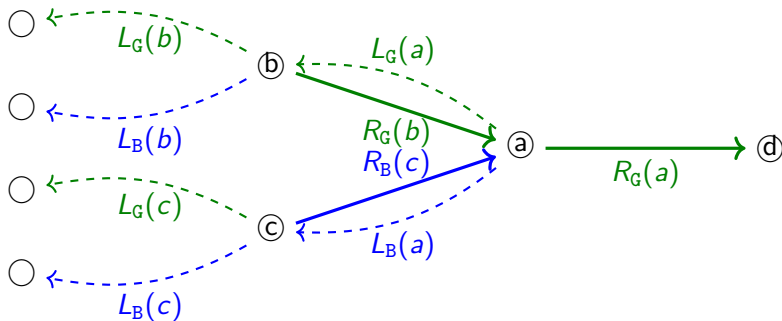

▷ This induces a binary tree structure.

▷ **Key observation:** In a bi-colored infinite binary tree, there is a canonical way to assign one-sided infinite paths to every node.

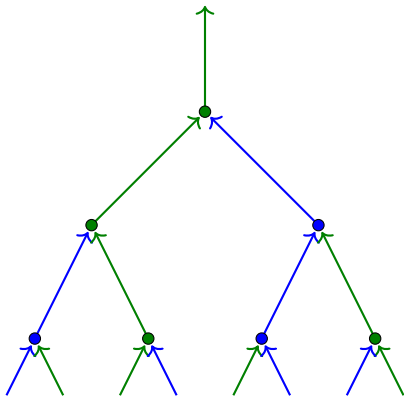

▷ **Key observation:** In a bi-colored infinite binary tree, there is a canonical way to assign one-sided infinite paths to every node.

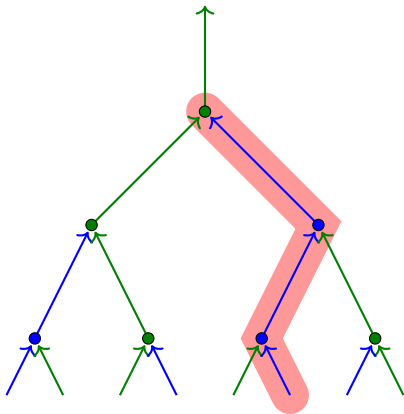

▷ **Key observation:** In a bi-colored infinite binary tree, there is a canonical way to assign one-sided infinite paths to every node.

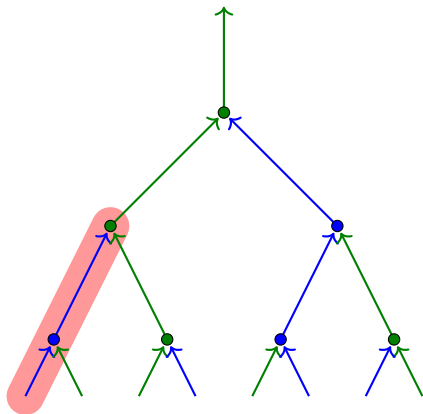

▷ **Key observation:** In a bi-colored infinite binary tree, there is a canonical way to assign one-sided infinite paths to every node.

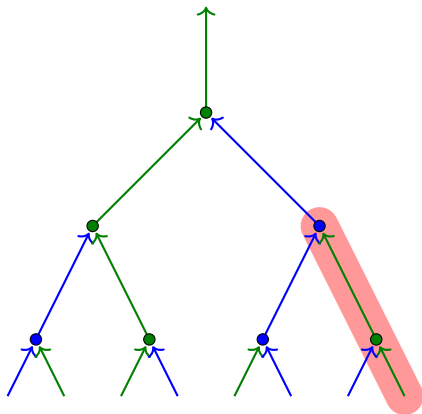

▷ **Key observation:** In a bi-colored infinite binary tree, there is a canonical way to assign one-sided infinite paths to every node.

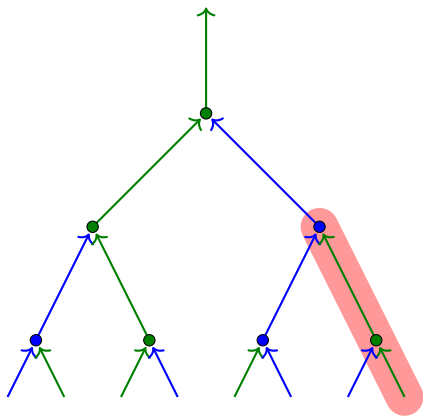

Follow the arrow tails of the opposite color!
The paths do not intersect.

Lemma

In every non-amenable group Γ there is a Γ -subshift of finite type \mathbf{P} called the **paradoxical shift** and a continuous function

$$\gamma: \mathbf{P} \times \mathbb{N} \times \Gamma \rightarrow \Gamma.$$

Such that for every $\rho \in \mathbf{P}$ the map

$$(n, g) \mapsto \gamma(\rho, n, g) \text{ for every } n \in \mathbb{N}, g \in \Gamma,$$

is 1-to-1.

Lemma

In every non-amenable group Γ there is a Γ -subshift of finite type \mathbf{P} called the **paradoxical shift** and a continuous function

$$\gamma: \mathbf{P} \times \mathbb{N} \times \Gamma \rightarrow \Gamma.$$

Such that for every $\rho \in \mathbf{P}$ the map

$$(n, g) \mapsto \gamma(\rho, n, g) \text{ for every } n \in \mathbb{N}, g \in \Gamma,$$

is 1-to-1.

In words: every configuration in the paradoxical shift encodes an assignment to every $g \in \Gamma$ of an infinite one-sided path with moves in a finite set $K \subseteq \Gamma$. Moreover, the paths do not intersect.

The paradoxical shift

Let $\Gamma = \Gamma_1 \times \Gamma_2$ be the product of two non-amenable groups.

The paradoxical shift

Let $\Gamma = \Gamma_1 \times \Gamma_2$ be the product of two non-amenable groups.

▷ taking the paradoxical subshift on each component, we obtain a subshift of finite type on Γ with the property that every configuration induces:

- a \mathbb{N}^2 -grid with moves in a finite set $K \subseteq \Gamma$ for every $g \in \Gamma$.
- The grids are pairwise disjoint.

The paradoxical shift

Let $\Gamma = \Gamma_1 \times \Gamma_2$ be the product of two non-amenable groups.

▷ taking the paradoxical subshift on each component, we obtain a subshift of finite type on Γ with the property that every configuration induces:

- a \mathbb{N}^2 -grid with moves in a finite set $K \subseteq \Gamma$ for every $g \in \Gamma$.
- The grids are pairwise disjoint.

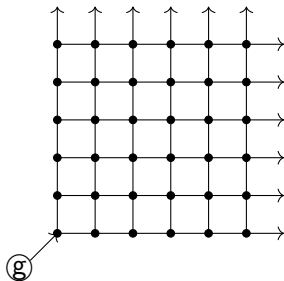

What do we do with grids? encode Turing machines

- ▷ We use the grids to encode computation using Wang tilings.

What do we do with grids? encode Turing machines

▷ We use the grids to encode computation using Wang tilings.

Given a Turing machine with alphabet Σ , states Q , starting state q_0 and transition function

$$\delta: Q \times \Sigma \rightarrow Q \times \Sigma \rightarrow \{-1, 0, 1\},$$

What do we do with grids? encode Turing machines

▷ We use the grids to encode computation using Wang tilings.

Given a Turing machine with alphabet Σ , states Q , starting state q_0 and transition function

$$\delta: Q \times \Sigma \rightarrow Q \times \Sigma \rightarrow \{-1, 0, 1\},$$

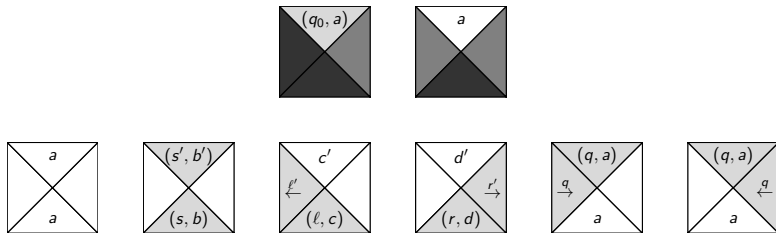

Where $\delta(s, b) = (s', b', 0)$, $\delta(l, c) = (l', c', -1)$ and $\delta(r, d) = (r', d', 1)$.

What do we do with grids? encode Turing machines

- ▷ We use the grids to encode computation using Wang tilings.

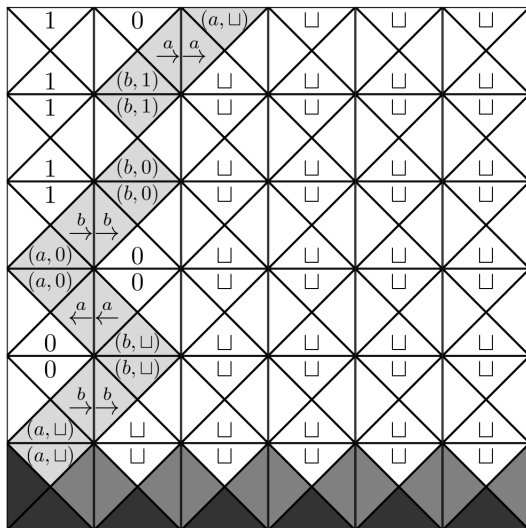

In our case:

- Take the alphabet of the set representation of $\Gamma \curvearrowright X$ and use it as tape alphabet.

In our case:

- Take the alphabet of the set representation of $\Gamma \curvearrowright X$ and use it as tape alphabet.
- Encode the Turing machine which enumerates all cylinders which are in the complement of the set representation.

In our case:

- Take the alphabet of the set representation of $\Gamma \curvearrowright X$ and use it as tape alphabet.
- Encode the Turing machine which enumerates all cylinders which are in the complement of the set representation.
- Take out the tiles containing the accepting state.

In our case:

- Take the alphabet of the set representation of $\Gamma \curvearrowright X$ and use it as tape alphabet.
- Encode the Turing machine which enumerates all cylinders which are in the complement of the set representation.
- Take out the tiles containing the accepting state.

Result: The only remaining configurations are the ones in the set representation.

Start with $x = x_0x_1x_2x_3 \cdots \in A^{\mathbb{N}}$

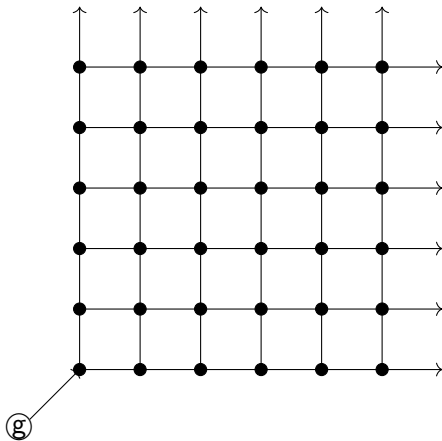

Start with $x = x_0x_1x_2x_3 \cdots \in A^{\mathbb{N}}$

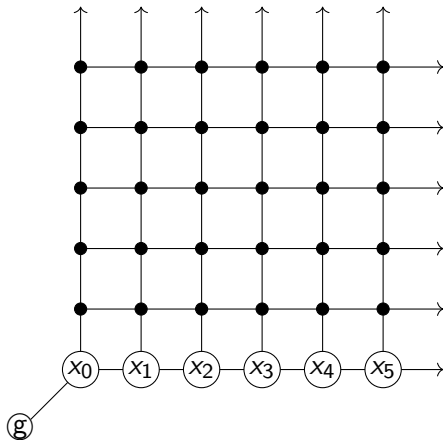

Start with $x = x_0x_1x_2x_3 \cdots \in A^{\mathbb{N}}$

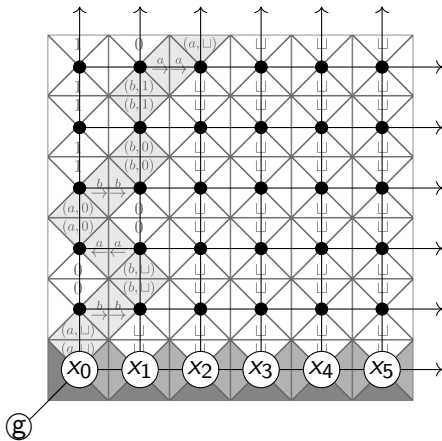

Start with $x = x_0x_1x_2x_3 \cdots \in A^{\mathbb{N}}$

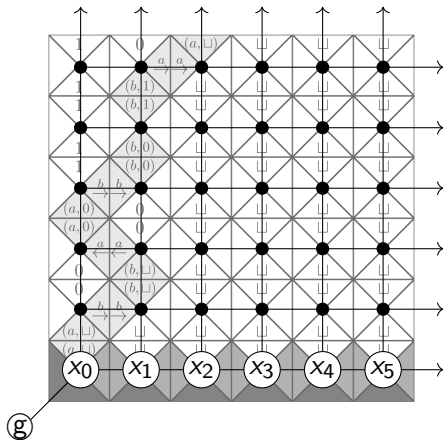

If the configuration survives (i.e. If the Turing machine does not stop), then x is in the set representation of $\Gamma \curvearrowright X$.

Now we have:

- A subshift which assigns to every $g \in \Gamma$ a \mathbb{N}^2 -grid.

Now we have:

- A subshift which assigns to every $g \in \Gamma$ a \mathbb{N}^2 -grid.
- For every $g \in \Gamma$, we have an element $y \in Y$ of the set representation of $\Gamma \curvearrowright X$.

Now we have:

- A subshift which assigns to every $g \in \Gamma$ a \mathbb{N}^2 -grid.
- For every $g \in \Gamma$, we have an element $y \in Y$ of the set representation of $\Gamma \curvearrowright X$.
- That is, for every $g \in \Gamma$ we have encoded $\{sx_g\}_{s \in S} \subseteq X$ for a generating set S of Γ .

Now we have:

- A subshift which assigns to every $g \in \Gamma$ a \mathbb{N}^2 -grid.
- For every $g \in \Gamma$, we have an element $y \in Y$ of the set representation of $\Gamma \curvearrowright X$.
- That is, for every $g \in \Gamma$ we have encoded $\{sx_g\}_{s \in S} \subseteq X$ for a generating set S of Γ .
- Weave together all the \mathbb{N}^2 -grids imposing that the configuration x_{gs} in gs coincides with $s^{-1}x_g$ through local rules.

Now we have:

- A subshift which assigns to every $g \in \Gamma$ a \mathbb{N}^2 -grid.
- For every $g \in \Gamma$, we have an element $y \in Y$ of the set representation of $\Gamma \curvearrowright X$.
- That is, for every $g \in \Gamma$ we have encoded $\{sx_g\}_{s \in S} \subseteq X$ for a generating set S of Γ .
- Weave together all the \mathbb{N}^2 -grids imposing that the configuration x_{gs} in gs coincides with $s^{-1}x_g$ through local rules.

Thus we obtain a natural factor map from this subshift of finite type to $\Gamma \curvearrowright X$.

Theorem (B., Sablik, Salo 2021)

The direct product $\Gamma = \Gamma_1 \times \Gamma_2$ of any pair of non-amenable finitely generated groups is self-simulable.

Theorem (B., Sablik, Salo 2021)

The direct product $\Gamma = \Gamma_1 \times \Gamma_2$ of any pair of non-amenable finitely generated groups is self-simulable.

But we have more!

- Self-simulable groups are stable under commensurability.

Theorem (B., Sablik, Salo 2021)

The direct product $\Gamma = \Gamma_1 \times \Gamma_2$ of any pair of non-amenable finitely generated groups is self-simulable.

But we have more!

- Self-simulable groups are stable under commensurability.
- Self-simulable groups are stable under quasi-isometries of finitely presented groups.

Theorem (B., Sablik, Salo 2021)

The direct product $\Gamma = \Gamma_1 \times \Gamma_2$ of any pair of non-amenable finitely generated groups is self-simulable.

But we have more!

- Self-simulable groups are stable under commensurability.
- Self-simulable groups are stable under quasi-isometries of finitely presented groups.
- Any group which has a normal self-simulable group is self-simulable.

Theorem (B., Sablik, Salo 2021)

The direct product $\Gamma = \Gamma_1 \times \Gamma_2$ of any pair of non-amenable finitely generated groups is self-simulable.

But we have more!

- Self-simulable groups are stable under commensurability.
- Self-simulable groups are stable under quasi-isometries of finitely presented groups.
- Any group which has a normal self-simulable group is self-simulable.
- Any group Γ generated by S which has a self-simulable group Δ with the property that $\Delta \cap s\Delta s^{-1}$ is non-amenable for every $s \in S$ is self-simulable.

Mixing the stability properties of this class, we obtain handy ways to show self-simulability:

Lemma

Let Γ be a group which acts faithfully on $X = \{0, 1\}^{\mathbb{N}}$ such that for any non-empty open set U the subgroup Γ_U which fixes every element of $X \setminus U$ is non-amenable. Then Γ is self-simulable.

Mixing the stability properties of this class, we obtain handy ways to show self-simulability:

Lemma

Let Γ be a group which acts faithfully on $X = \{0, 1\}^{\mathbb{N}}$ such that for any non-empty open set U the subgroup Γ_U which fixes every element of $X \setminus U$ is non-amenable. Then Γ is self-simulable.

Theorem: Thompson's V is self-simulable

Proof: Consider the natural action $V \curvearrowright \{0, 1\}^{\mathbb{N}}$ of Thompson's V . For any non-trivial word $w \in \{0, 1\}^*$ the subgroup of V which fixes $X \setminus [w]$ is isomorphic to V (which is non-amenable).

Very old and hard question: is Thompson's F amenable?

Very old and hard question: is Thompson's F amenable?

We get a computable reformulation of this open question:

Theorem: Thompson's F is self-simulable if and only if F is non-amenable.

Very old and hard question: is Thompson's F amenable?

We get a computable reformulation of this open question:

Theorem: Thompson's F is self-simulable if and only if F is non-amenable.

Proof: Amenable recursively presented groups are never self-simulable.

Consider the natural action $F \curvearrowright \{0, 1\}^{\mathbb{N}}$ of Thompson's F . For any non-trivial word $w \in \{0, 1\}^*$ the subgroup of F which fixes $X \setminus [w]$ is isomorphic to F . As we suppose that F is non-amenable, the lemma holds and we get that F is self-simulable.

Very old and hard question: is Thompson's F amenable?

We get a computable reformulation of this open question:

Theorem: Thompson's F is self-simulable if and only if F is non-amenable.

Proof: Amenable recursively presented groups are never self-simulable.

Consider the natural action $F \curvearrowright \{0, 1\}^{\mathbb{N}}$ of Thompson's F . For any non-trivial word $w \in \{0, 1\}^*$ the subgroup of F which fixes $X \setminus [w]$ is isomorphic to F . As we suppose that F is non-amenable, the lemma holds and we get that F is self-simulable.

To show that F is amenable, it would then suffice to construct an effectively closed F -action which is not the factor of an F -subshift of finite type (no idea how to do this).

The following groups are self-simulable:

- Finitely generated non-amenable branch groups.
- The finitely presented simple groups of Burger and Mozes.
- Thompson's group V and higher-dimensional Brin-Thompson's groups nV .
- The general linear groups $GL_n(\mathbb{Z})$ and special linear groups $SL_n(\mathbb{Z})$ for $n \geq 5$.
- The automorphism group $\text{Aut}(F_n)$ and outer automorphism group $\text{Out}(F_n)$ of the free group on at least $n \geq 5$ generators.
- Braid groups B_n on at least $n \geq 7$ strands.
- Right-angled Artin groups associated to the complement of a finite connected graph for which there are two edges at distance at least 3.

▷ Suppose $\Gamma \curvearrowright X$ admits a free effectively closed action (for every $x \in X$ then $gx = x$ implies that $g = 1_\Gamma$)

$$\text{(SFT)} \quad \Gamma \curvearrowright Z \xrightarrow{\text{factor}} \Gamma \curvearrowright X$$

▷ Suppose $\Gamma \curvearrowright X$ admits a free effectively closed action (for every $x \in X$ then $gx = x$ implies that $g = 1_\Gamma$)

$$\text{(SFT)} \quad \Gamma \curvearrowright Z \xrightarrow{\text{factor}} \Gamma \curvearrowright X$$

Then the shift action of Γ on Z is free.

▷ Suppose $\Gamma \curvearrowright X$ admits a free effectively closed action (for every $x \in X$ then $gx = x$ implies that $g = 1_\Gamma$)

$$\text{(SFT)} \quad \Gamma \curvearrowright Z \xrightarrow{\text{factor}} \Gamma \curvearrowright X$$

Then the shift action of Γ on Z is free.

Theorem (Aubrun, B., Thomassé 2019)

Every finitely generated group with decidable word problem Γ admits an effectively closed Γ -subshift on which Γ acts freely.

▷ Suppose $\Gamma \curvearrowright X$ admits a free effectively closed action (for every $x \in X$ then $gx = x$ implies that $g = 1_\Gamma$)

$$\text{(SFT)} \quad \Gamma \curvearrowright Z \xrightarrow{\text{factor}} \Gamma \curvearrowright X$$

Then the shift action of Γ on Z is free.

Theorem (Aubrun, B., Thomassé 2019)

Every finitely generated group with decidable word problem Γ admits an effectively closed Γ -subshift on which Γ acts freely.

Corollary

Every self-simulable group Γ with decidable word problem admits a Γ -SFT on which Γ acts freely.

Thank you for your attention!

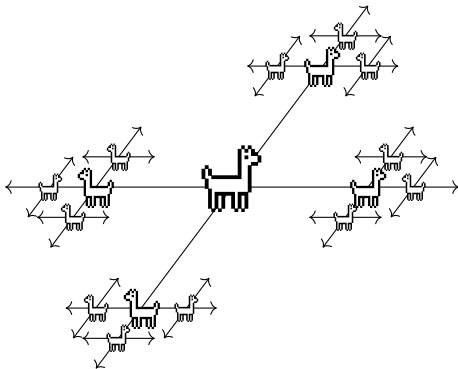

Groups with self-similable zero-dimensional dynamics

S. Barbieri, M. Sablik and V. Salo

<https://arxiv.org/abs/2104.05141>