



THÈSE PRÉSENTÉE  
POUR OBTENIR LE GRADE DE  
**DOCTEUR**  
**DE L'UNIVERSITÉ DE BORDEAUX**

ÉCOLE DOCTORALE DE MATHÉMATIQUES ET  
D'INFORMATIQUE

Spécialité : INFORMATIQUE

Par **Jonathan NARBONI**

Graph Coloring and Recoloring

Sous la direction de : **Éric SOPENA**

Co-directeur : **František Kardoš**

Encadrante : **Marthe BONAMY**

Soutenue le 12 Juillet 2022

Membres du jury :

Mme. Marthe BONAMY	Chargée de recherche	Université de Bordeaux	Membre invitée
M. Louis ESPERET	Directeur de recherche	Université de Grenoble	Rapporteur
Mme. Penny HAXELL	Professor	University of Waterloo	Rapportrice
Mme. František Kardoš	Maître de conférences	Université de Bordeaux	Directeur
M. Bojan MOHAR	Professor	Simon Fraser University	Examinateur
Mme. Anca MUSCHOLL	Professeure des universités	Université de Bordeaux	Examinatrice
M. Éric SOPENA	Professeur des universités	Université de Bordeaux	Directeur
M. Xuding ZHU	Professor	ZheJiang Normal University	Rapporteur



# Contents

<b>1 Preliminaries</b>	<b>7</b>
1.1 Definitions, basic properties and notation . . . . .	7
1.1.1 Definitions and general properties of graphs . . . . .	7
1.1.2 Adjacency and neighborhood . . . . .	9
1.1.3 Walks, paths and cycles . . . . .	11
1.1.4 Directed graphs . . . . .	12
1.2 Several important graph classes . . . . .	14
1.2.1 Forests . . . . .	14
1.2.2 Embeddings, drawings and planar graphs . . . . .	15
1.3 Graph coloring . . . . .	18
1.3.1 Definitions and basic properties . . . . .	18
1.3.2 Coloring the edges . . . . .	19
1.3.3 Basic results . . . . .	19
1.3.4 Coloring planar graphs . . . . .	21
1.3.5 Graph minors and coloring . . . . .	24
1.3.6 Signed graphs and signed coloring . . . . .	26
1.4 Graph coloring reconfiguration: Kempe chains . . . . .	29
1.4.1 Preliminaries . . . . .	29
1.4.2 Kempe chains and Kempe swaps . . . . .	30
1.4.3 Kempe chains and edge-coloring . . . . .	32
1.4.4 Reconfiguration questions: Kempe equivalence . . . . .	35
<b>2 Vizing's edge-coloring conjecture</b>	<b>39</b>
2.1 Introduction . . . . .	39
2.1.1 General setting of the proof . . . . .	41
2.1.2 Fan-like tools . . . . .	42
2.1.3 Gentle introduction: a proof of Observation 2.1.8 . . . . .	44
2.1.4 Comets: a proof of Lemma 2.1.11 . . . . .	45
2.1.5 Non-saturated cycles: a proof of Lemma 2.1.10 . . . . .	45
2.2 Vizing's edge-coloring conjecture for triangle-free graphs . . . . .	46
2.2.1 Double cycles . . . . .	46

2.2.2	The good, the bad and the ugly (edges) . . . . .	49
2.3	Vizing's edge-coloring conjecture: the general case . . . . .	52
2.3.1	General outline and notations . . . . .	54
2.3.2	Only cycles around $v$ : a proof of lemma 2.3.11 . . . . .	58
2.4	Fans around $\mathcal{V}$ : a proof of Lemma 2.3.13 . . . . .	59
2.5	Cycles around $v$ starting with $u$ : a proof of Lemma 2.3.14 . . . . .	62
2.5.1	$(\mathcal{V}, u)$ -independent fans . . . . .	62
2.5.2	Proof of $P(0)$ . . . . .	69
2.5.3	Fans around the vertices of a minimum cycle . . . . .	77
2.5.4	Properties guaranteed by $P(i)$ . . . . .	80
2.5.5	The property $Q(i)$ . . . . .	89
2.5.6	Proof of $P(i)$ . . . . .	96
2.6	Cycles interactions . . . . .	102
<b>3</b>	<b>Other reconfiguration problems</b>	<b>105</b>
3.1	A reconfiguration version of Hadwiger's conjecture . . . . .	105
3.1.1	Introduction . . . . .	105
3.1.2	Construction . . . . .	107
3.2	Connected greedy edge-coloring . . . . .	110
3.2.1	Introduction . . . . .	110
3.2.2	Proof of NP-hardness . . . . .	111
3.2.3	Bipartite graphs . . . . .	115
3.2.4	Subcubic graphs . . . . .	118
<b>4</b>	<b>From coloring to edge-labeling</b>	<b>123</b>
4.1	4-signed coloring of signed planar graphs . . . . .	123
4.1.1	Introduction . . . . .	123
4.1.2	Results . . . . .	124
4.1.3	Concluding remarks . . . . .	133
4.2	Towards 4-edge-coloring of triangle-free planar graphs of maximum degree 4 . . . . .	134
4.2.1	Introduction . . . . .	134
4.2.2	General approach . . . . .	136
4.2.3	Group labelings and lollipops . . . . .	137
4.2.4	Partial results . . . . .	152

---

## Remerciements

Je tenais tout d’abord et bien évidemment à remercier mes encadrants Marthe, Feri et Éric, qui chacun à leur manière m’ont apporté le soutien et l’aide nécessaires pour faire cette thèse.

Merci à mes rapporteurs Louis Esperet, Zhu Xuding, Penny Haxell, pour leur lecture attentive de mon manuscrit et pour leur retour, ainsi qu’à mes examinateurs Anca Muscholl et Bojan Mohar. Merci à l’équipe Graphes et Optimisation du LaBRI, et plus généralement à l’équipe CombAlgo qui m’ont accueilli en leur sein. En particulier merci à Claire (Hilaire), Alex (Blanché), Paul (Ouvrard), Théo (Pierron), Clément (Legrand), Ralph (Kleising), Cyril (Gavoille) et Nicolas (Bonichon).

Merci aux habitants (de long ou court séjour) du bureau 123, qui ont permis de transformer ce morose open-space en lieu de vie dont la réputation de *coolitude* a pu dépasser le premier étage du laboratoire. En particulier merci à Quentin (Manière) et ses “hanabdays”, et à Jana (Lepsová) pour ses concerts privés. Merci aux membres de l’AFODIB qui ont su animer ce labo, et en particulier à Rohan (Fossé), Aline (Roc), Joséphine (Calendra), Rémy (Morvan), Antonio (Casarès Santos), Sarah (Larroze-Jardiné), Zoé (Varin) et Thimothé (Corsini).

Merci aussi à mes collègues d’enseignement, et notamment merci à Jean-Rémy (Fallieri) pour la liberté qu’il a pu me donner, et à Georges (Eyrolle) et David (Renault) pour leurs conseils souvent (toujours ?) avisés et leur bonne humeur communicative. Merci aux personnes de l’accueil du LaBRI, et en particulier à Safia Amsili, et Sylvie le Laurain qui ont souvent su interpréter avec discernement le règlement intérieur.

Merci aussi à tous ceux avec qui j’ai pu collaborer lors de ces trois années: Oscar Defrain, Téréza Klimošová, Aurélie Lagoutte, Reza Nasarasr, Wang Zhouningxin, Théo Pierron, Dimitri Lajou, Jan Bok, Nikola Jedličková, Clément Legrand-Duchesne, Marc Heinrich, Nicola Bousquet, Valentin Gledel, Hoang La, Valentin Bartier, Laurine Beneteau, Carole Muller, Carla Groenland, Jakub Pekarek, Alexandra Wesolek, Petru Valicov, Alexandre Pinlou, Jean-Florent Raymond, Marco Cauduro, Laurent Feuilloley, Virginia Ardévol-Martinéz, Pegah Pournajafi, Vincent Delecroix, Rémy Laplace et Dan Cranston. Merci aussi à tous ceux que j’ai pu rencontrer pendant ma thèse et qui m’ont aidé de toutes les manières possibles, en particulier, merci à Thomas Degueule, Amer Mouawad, Carl Feghali, Tassio Naia Dos Santos, Florent Foucauld, Paul Bastide, Daniel Gonçalves, Sébastien Labbé, Meghyn Bienvenue, Pierre Casteran et Pascal Weil.

---

Et pour terminer cette (peut-être trop) longue anaphore, un merci particulier à mes parents Thierry et Mireille, mon frère Julien et ma nièce Romane ainsi qu'à ceux qui me sont les plus proches: Julien, Anne, Cyril et Julie et leur marmailles Tom, Sam, Ezzio et Ava, qui ont toujours répondu présents quand j'en avais besoin. Et enfin surtout merci à Nathalie, pour son soutien sans faille dans la dernière ligne droite.

---

# Introduction

## A few words on graph coloring and graph recoloring

This thesis falls within the field of graph theory, and focuses more particularly on graph coloring and graph recoloring. Graphs are combinatorial objects which consist of a set of *vertices* that may be pairwise connected by some *edges*. Graphs can essentially model any binary relation on a set, and thus have various applications in many other fields, from timetable scheduling to modeling interactions between elementary particles, including jobs allocation on a CPU, path finding in a network, Sudoku grid solving etc.

In this thesis, we particularly study the problem of graph coloring. This problem consists in giving a color to the vertices (or the edges) of a graph in such a way that the colors verify some given constraint. In the usual version of the problem, one needs to color the vertices of a graph such that no pair of adjacent vertices (*i.e.* vertices that are connected by an edge) receives the same color. Since one can always give to each vertex a different color, and thus obtain a  $n$ -coloring of a graph with  $n$  vertices, the usual question regarding graph coloring is the following: what is the minimum number of colors needed to color the vertices of a graph?

This problem originally comes from an observation made by Francis Guthrie in the 19<sup>th</sup> century. He observed that 4 colors were always sufficient to color the map of the English counties in such a way that no counties sharing a border receive the same color. This observation became one of the most famous and studied conjecture in graph theory: every planar graph is 4-colorable. Indeed to model this problem with graphs, it suffices to represent each county's capital by a vertex, and to connect two vertices if their respective counties share a border. Albeit very simple to state, this conjecture remained unsolved for decades. Alfred Kempe was the first to claim having a proof of this conjecture. His idea is simple yet ingenious. When coloring the vertices of a graph, it may not be possible to directly give to each vertex its definitive color. During the coloring process, a vertex  $v$  may be at first given the color red, only to be later on colored green as it turns out to be more convenient.

It turns out that Kempe's proof of the four-color conjecture was false, but the recoloring operation he introduced, the *Kempe changes*, became a fruitful technical tool regarding graph coloring. The crucial part of these Kempe changes is that a good partial coloring (with no monochromatic pair of adjacent vertices) is guaranteed to remain a good partial coloring after the change. Almost a century after Kempe's attempt, a correct proof of the four-color conjecture was finally found by Appel and Haken [AH76] in 1976, and one of the two key ideas of their proof is Kempe change (the other one being the *discharging method* which

---

has also become a standard tool in graph coloring, but will not be discussed in this thesis see [CW17] for a nice introduction to the discharging method). Since then, many results on graph coloring were found using this recoloring technique, which is one of the central concepts studied in this thesis.

However, if we can recolor the vertices in a partial coloring to bound the number of colors needed, we can also recolor a (complete) coloring to transform it into another coloring. If trying to color the vertices of a graph with a limited amount of colors can be seen as solving a Sudoku grid, trying to transform an existing coloring into another coloring using simple modifications can be seen as solving a Rubik's cube. This kind of question falls within the more general field of combinatorial reconfiguration which this thesis largely focuses on. More formally, given a set  $S$  of solutions to a given problem (here colorings), and an elementary operation to "locally" modify the solutions: is it always possible to change a solution  $A$  into a target solution  $B$  only using the elementary operation and such that each intermediate step is also a solution in  $S$ ?

## Layout of the manuscript

In this thesis, we are only interested in graph coloring and recoloring problems, with a focus on edge-coloring. In Chapter 1, we first introduce some basic definitions and notations related to graph theory and graph coloring used throughout this manuscript. In Section 1.3, we give a more detailed introduction to graph coloring: we present the problem, give some known results and introduce some notions connected to the graphs coloring questions. In Section 1.4, we introduce a concept central in this thesis: *Kempe chains*. This concept is the base idea of graph coloring reconfiguration (or graph recoloring), and is one of the technical tools that were intensively studied during this thesis. We thus give an overview of the history of this tool, and present some classical proof techniques that use this tool. Since edge-coloring is of special interest, we discuss Kempe chains in that context. We present Vizing's fans, one of the key tools towards the seminal result of Vizing on edge-coloring. They will prove to be crucial in the following section.

In Chapter 2, we solve a 1965 conjecture of Vizing in edge-recoloring. He conjectured that any non-optimal edge-coloring can be reconfigured (using exclusively Kempe changes) into some optimal edge-coloring. We prove this to be true; we prove in fact that the target optimal edge-coloring can be chosen arbitrarily. We present the progress in a chronological order. In Section 2.2, we show how to handle the case of triangle-free graphs, which is joint work with Marthe Bonamy, Oscar Defrain, Tereza Klimošová, and Aurelie Lagoutte [BDK<sup>+</sup>21], and discuss the limitations in removing the triangle-free hypothesis. In Section 2.3, we then show how to bypass those limitations, which is a single author paper in



---

preparation.

In Chapter 4, we present our work on some graph coloring of planar graphs. In Section 4.1, we present joint work with František Kardoš [KN21]. We disprove a conjecture of Máčajová, Raspaud and Škoviera that generalizes the four-color theorem. They conjectured that all signed planar graphs are 4-signed colorable. We generalize to signed planar graphs the reduction of vertex-coloring of a triangulation to edge-coloring of the dual graph used in the proof of the four-color theorem, and present a counter-example to the conjecture.

In Section 4.2, we present joint work with František Kardoš towards the following conjecture of Vizing on edge-coloring of planar graphs: all triangle-free planar graphs of maximum degree 4 are 4-edge-colorable. The case of triangle-free planar graphs of maximum degree 4 is one of the last open cases regarding the chromatic index of planar graphs. During this PhD, we could not prove nor disprove the conjecture. Nevertheless, we present our partial results and the general approach that we use towards this question. Both these works have a common approach: reducing the original coloring question to a question of edge-labeling of an auxiliary graph.



# Chapter 1

## Preliminaries

In this chapter we recall all the definitions used in this thesis, and present the main concepts studied in this manuscript. In Section 1.1 we give the definitions, recall some basic properties, and introduce the notations that we will use in this thesis, in Section 1.2, we present some of the main graph classes we study in this thesis, in Section 1.3 we give an illustrated introduction to graph coloring, and in Section 1.4 we present the central notions of this thesis: Kempe chains and recoloring.

### 1.1 Definitions, basic properties and notation

#### 1.1.1 Definitions and general properties of graphs

A graph is essentially a set of points connected by some lines. Formally, a *graph*  $G$  is an ordered pair  $(V, E)$  where  $V$  is a finite set (we only consider infinite graphs in one context in this thesis, and will explicitly mention it there) and  $E \subseteq \binom{V}{2}$  (where  $\binom{V}{2}$  is the set of subsets of  $V$  of size 2). In the literature, a more general definition of *graphs* can be found (where  $E$  is a multiset, and where elements of  $E$  are also multisets), the definition given above corresponds to the definition

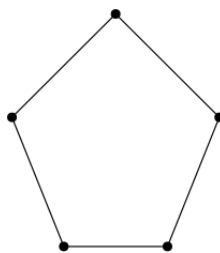

Figure 1.1: An example of a graph depicted in the standard way.

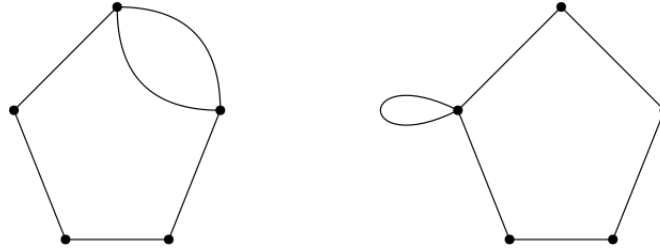

Figure 1.2: On the left-hand side an example of a multigraph with a multiedge, on the right-hand side, an example of a multigraph with a loop .

of **simple graphs**. In this thesis, we generally only consider **simple graphs**, thus we will usually drop the “simple”, and will explicitly write **multigraphs** otherwise. Moreover, when considering multigraphs, we almost never consider graphs with **loops**, *i.e.*, where elements of  $E$  are multisets, thus we will always explicitly mention it when it is the case. We usually call a set of graphs satisfying a certain property a **graph class**.

For a graph  $G = (V, E)$ , the elements of  $V$  are called the **vertices** of  $G$ , and the elements of  $E$  are called the **edges** of  $G$ ;  $V(G)$  denotes the set of vertices of  $G$ , and  $E(G)$  denotes the set of edges of  $G$ . We usually picture graphs using points to depict the vertices and lines (or curves) between these points to represent the edges. The graph with no vertex is called the **empty graph**. The **complement** of  $G$ , denoted by  $\overline{G}$ , is the graph with vertex set  $V(G)$ , and edge set  $\binom{V}{2} \setminus E(G)$ . The **line graph** of a graph  $G$ , denoted by  $L(G)$ , is the graph with vertex set  $E(G)$ , and where there is an edge between two vertices of  $L(G)$  if the corresponding edges in  $G$  share a vertex.

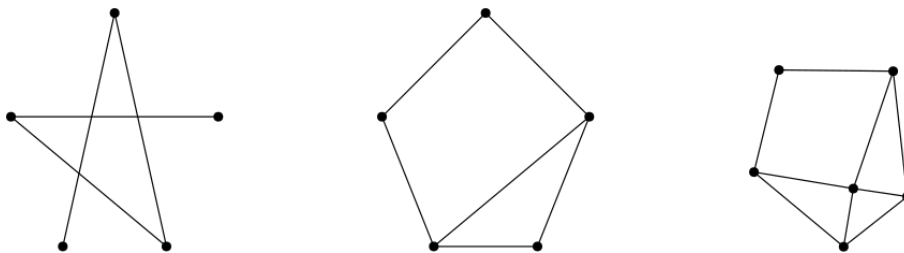

Figure 1.3: In the center, an example of a graph, on the left-hand side, the complement of this graph, and on the right-hand side, the line graph of this graph.

The **order** of  $G$  is the cardinality of  $V(G)$  and is often denoted by  $n(G)$  (or simply  $n$  when there is no ambiguity); the **size** of  $G$  is the cardinality of  $E(G)$ , and is often denoted by  $m(G)$  (or simply  $m$  when there is no ambiguity). Note that as  $E(G) \subseteq \binom{V(G)}{2}$ . So given a vertex set, there is a maximum number of edges in

the graph:  $m \leq \binom{n}{2} = \mathcal{O}(n^2)$ . A graph  $H$  is called *isomorphic* to  $G$  if there exists a bijection  $\varphi : V(G) \rightarrow V(H)$  such that  $uv \in E(G) \Leftrightarrow \varphi(u)\varphi(v) \in E(H)$ ; we generally do not distinguish *isomorphic* graphs and write directly  $H = G$  if  $G$  and  $H$  are isomorphic. A graph  $H$  is a *subgraph* of  $G$  (denoted by  $H \subseteq G$ ) if  $V(H) \subseteq V(G)$  and  $E(H) \subseteq E(G)$ ; if  $V(H) = V(G)$ , then  $H$  is a *spanning subgraph* of  $G$ . If  $H$  is a *subgraph* of  $G$  and contains all the edges  $uv \in E$  with  $u, v \in V(H)$ , then  $H$  is called an *induced subgraph* of  $G$ , and we write  $H \subseteq_{ind} G$ . If  $S \subseteq V(G)$  is a subset of vertices of a graph  $G$ , the subgraph of  $G$  induced by  $S$  is denoted by  $G[S]$ , and the subgraph of  $G$  induced by  $V \setminus S$  is denoted by  $G \setminus S$ .

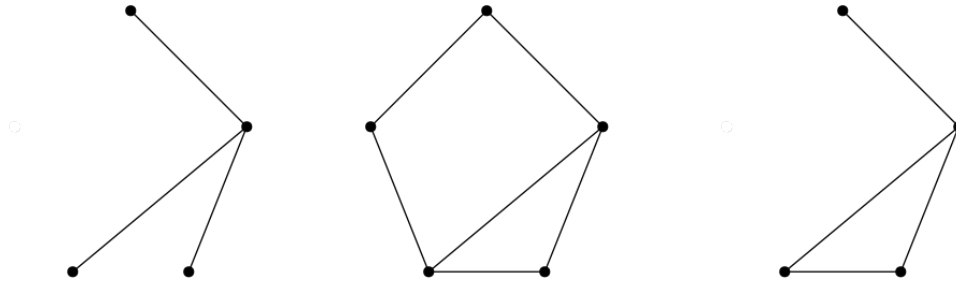

Figure 1.4: In the center, an example of a graph, on the left-hand side, a subgraph of this graph, and on the right-hand side, an induced subgraph of this graph.

### 1.1.2 Adjacency and neighborhood

Let  $u$  and  $v$  be two vertices of  $G$ , if  $e = \{u, v\} \in E(G)$ , then the edge  $e$  *connects* the vertex  $u$  and the vertex  $v$ ;  $u$  is called a *neighbor* of  $v$  (and vice versa),  $u$  and  $v$  are called *adjacent* vertices, and are the *end-vertices* (or simply the ends) of  $e$ . The edge  $e$  is *incident* with  $u$  and  $v$ , and is often simply denoted by  $uv$  when there is no ambiguity. If two edges share a common vertex, we say that the edges are adjacent (equivalently their corresponding vertices in the line graph are adjacent). The set of neighbors of  $v$  is called the *open neighborhood* of  $v$  (or simply the neighborhood of  $v$ ) and is denoted by  $N(v)$ ; the set  $N(v) \cup \{v\}$  is called the *closed neighborhood* of  $v$  and is denoted by  $N[v]$ .

The number of *neighbors* of a vertex  $v$  in  $V(G)$  is called its *degree*, and is denoted by  $d(v)$ . If the vertex  $v$  has no neighbor, then  $v$  is called an *isolated vertex*. The *maximum degree* (respectively the *minimum degree*) of  $G$ , denoted by  $\Delta(G)$ , (respectively  $\delta(G)$ ) is the maximum (respectively the minimum) over all the *degrees* of  $G$ . More formally, we have,

$$\Delta(G) = \max_{v \in V(G)} (d(v)) \text{ and } \delta(G) = \min_{v \in V(G)} (d(v)).$$

The graph  $G$  is  *$k$ -regular*, if every vertex of  $G$  has *degree*  $k$ ; if  $G$  has only vertices of degree 3,  $G$  is *cubic*. A graph is  *$k$ -degenerate* if for any non-empty subgraph of  $G$  there exists a vertex  $v$  of degree at most  $k$ . Note that if a graph  $G$  is not  $\Delta(G)$ -regular, then  $G$  is  $\Delta(G)$ -degenerate. A  $k$ -degenerate graph  $G$  yields a natural ordering on its vertices  $(v_1, \dots, v_n)$  in the following way: the vertex  $v_1$  is a vertex of degree at most  $k$  in  $G$ , and each  $v_i$  is a vertex of degree at most  $k$  in  $G \setminus \bigcup_{j<i} v_j$ ; this order is the order induced by the degeneracy of  $G$  (or simply the degeneracy order of  $G$ ).

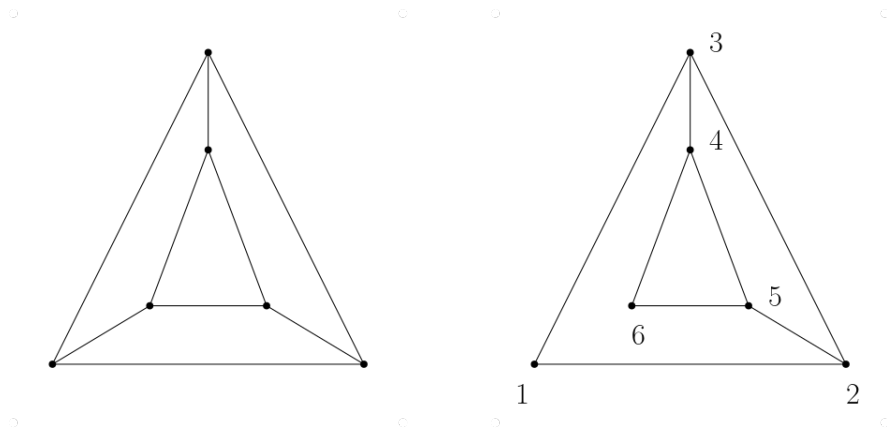

Figure 1.5: On the left-hand side an example of a cubic graph: the triangular prism; on the right-hand side, an example of a 2-degenerate graph with the vertices labeled according to the degeneracy order.

A set of pairwise non-adjacent vertices of  $G$  is a *stable set* (or an *independent set*) of  $G$ ; the maximum size of a stable set of  $G$  is the *independence number* and is denoted by  $\alpha(G)$ . A set of pairwise non-adjacent edges is a *matching*; equivalently a matching is an independent set of the line graph. On the other hand, a set of pairwise adjacent vertices of  $G$  is called a *clique* of  $G$ ; the size of a maximum clique of  $G$  is called the *clique number* of  $G$  and is denoted by  $\omega(G)$ . Clearly,  $\alpha(G) = \omega(\overline{G})$  for any graph  $G$ . If  $G$  consists only of a clique on  $k$  vertices, then  $G$  is called the *complete graph* on  $k$  vertices, and is denoted by  $K_k$ . Recall that we only consider graphs up to isomorphism, so there is a unique complete graph on  $k$  vertices. *Subdividing* an edge  $uv$  of a graph  $G$  consists in replacing  $uv$  by a vertex  $w$  of degree 2 connected to  $u$  and  $v$ ; the graph  $G'$  obtained is called a subdivision of  $G$ .

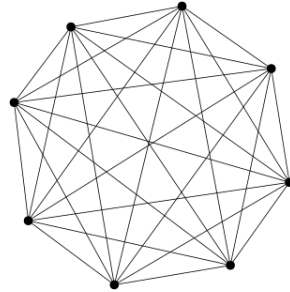

Figure 1.6: The complete graph on 8 vertices.

### 1.1.3 Walks, paths and cycles

A *walk*  $W$  (of length  $k$ ) is a sequence  $(v_0, v_1, \dots, v_k)$  where each  $v_i$  is a vertex of  $G$ , and each  $v_i v_{i+1}$  is an edge of  $G$ . If  $v_0 = v_k$ , then  $W$  is called a *closed walk*, otherwise it is called an open walk. An open walk with no repeated vertex is called a *path*; a path on  $k$  edges is denoted by  $P_k$ , and  $k$  is the *length* of the path. A closed walk with no repeated vertex (except the first one and the last one) is called a *cycle*; a cycle on  $k$  edges is denoted by  $C_k$  (similarly to paths,  $k$  is called the *length* of the cycle). The cycle on three vertices is denoted by  $C_3$  or  $K_3$  and is also called a *triangle*.

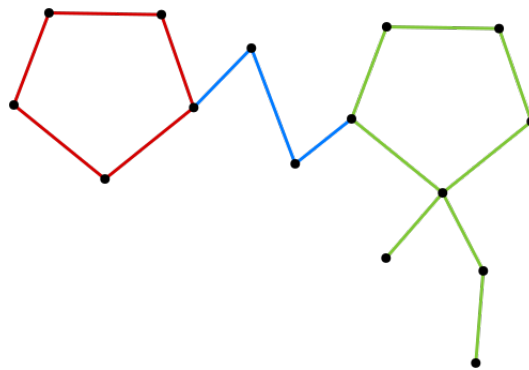

Figure 1.7: Three examples of walks: in red a cycle of length 5, in blue a path of length 3, and in green an open walk of length 8 with a repeated vertex.

If  $C_1$  and  $C_2$  are two cycles of  $G$ , the binary sum of  $C_1$  and  $C_2$  is the subgraph of  $G$  with vertex set  $V(C_1) \cup V(C_2)$  and edge set  $E(C_1) \cup E(C_2) \setminus (E(C_1) \cap E(C_2))$ . A *cycle base* of a graph  $G$  is a minimum set  $S$  of cycles of  $G$  such that any cycle of  $G$  can be obtained as the binary sum of cycles of  $S$ . If a graph  $G$  has a spanning cycle  $C$  as subgraph, then  $C$  is called an *Hamiltonian cycle* of  $G$ , and  $G$  is called Hamiltonian. Similarly, a path that spans all the vertices of a graph  $G$  is called an Hamiltonian path of  $G$ . A *subgraph* of a graph  $G$  which consists of

a union of cycles is a *2-factor*, note that a Hamiltonian cycle is a special case of 2-factor. The minimum size of a cycle of a graph  $G$  is called the *girth* of  $G$ , and is denoted by  $g(G)$ .

A graph  $G$  is called *connected* if for any pair of vertices  $u$  and  $v$  of  $G$ , there is a path between  $u$  and  $v$ , otherwise it is called *disconnected*. A maximal connected subgraph of  $G$  is called a *connected component*; if  $G$  is connected, then, it only has one connected component. Let  $u$  and  $v$  be two vertices of a graph  $G$ , the *distance* between  $u$  and  $v$  is the minimum length of a path between these two vertices; the *diameter* of  $G$  is the maximum distance between a pair of vertices of  $G$ . A set of vertices  $S \subseteq V(G)$  such that the graph induced by  $V(G) \setminus S$  is disconnected is called a *separator*. The *vertex-connectivity* of  $G$  (or simply the connectivity of  $G$ ), if  $G$  is not a complete graph, denoted by  $\kappa(G)$ , is the minimum size of a separator. The *edge-connectivity* of  $G$ , denoted by  $\lambda(G)$ , is the minimum number of edges to delete from  $G$  to obtain a disconnected graph (*i.e.* the minimum size of a separator of the *line graph*). Note that if a graph is at least 2-edge-connected, each vertex belongs to a cycle of the graph.

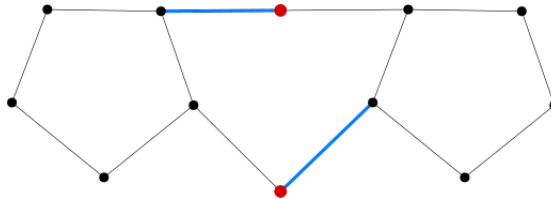

Figure 1.8: The two red vertices form a vertex separator of size 2, and the two blue edges form an edge separator of size 2: this graph is both 2-connected and 2-edge connected.

### 1.1.4 Directed graphs

*Directed graphs* (or digraphs) are basically graphs with an *orientation* of the edges, *i.e.* the edges are not 2-subsets of the set of vertices but ordered pairs. Formally, a *simple graph* whose edges are given an orientation is called an *oriented graph*. Digraphs are not central in this thesis, and we mainly use them as auxiliary graphs, thus we will not give an extensive introduction to them, but just some basic definitions of concepts related to digraphs needed to understand this manuscript. For an edge  $uv$  of a digraph  $G$ ,  $u$  is called the *tail* of  $uv$  and  $v$  is called the *head* of the edge. We naturally depict the digraph with arrows to represent their edges. Most of the definitions mentioned in the previous section can easily be generalized to digraphs.

Let  $G$  be a digraph, and  $v$  be a vertex of  $G$ . The *indegree* of  $v$  is the number of edges incident with  $v$  such that  $v$  is the head of these edges, conversely,



the *outdegree* of  $v$  is the number of edges incident with  $v$  such that  $v$  is the tail of these edges. Similarly to non-directed graphs, we can define the notions of *outneighborhood* (respectively *inneighborhood*) of a vertex  $v$ , denoted by  $N^+(v)$ , (respectively by  $N^-(v)$ ) as the set of inneighbors (respectively outneighbors) of  $v$ . The notions of *walks*, *paths*, and *cycles* can also be generalized to digraphs: an directed *walk*  $W = (v_1, v_2, \dots, v_k)$  only requires that each edge  $v_i v_{i+1}$  where  $v_i$  is the *tail* and  $v_{i+1}$  is the *head*. In a directed path  $P$ , the vertex with *indegree* 0 is called the *source* of  $P$ , and the vertex of outdegree 0 is called the *sink* of  $P$ .

## 1.2 Several important graph classes

In this section, we present some classical graph classes that we will consider in the next sections of this thesis.

### 1.2.1 Forests

A graph  $G$  that does not contain any cycle is called a *forest*; if  $G$  is acyclic and connected, then  $G$  is called a *tree*. It is easy to see that a *tree* has at least one vertex of degree at most 1 (if a tree has at least 2 vertices, then it has at least one vertex of degree 1). The vertices of degree 1 of a tree are called the *leaves*. Given a tree  $T$ , a vertex can be distinguished as the *root* of the  $T$ , the tree  $T$  is then called a *rooted tree*. From an algorithmic point of view, rooted trees are particularly important since they induce a partial ordering on the vertices: each vertex  $v$  of a rooted tree (except the root) has a unique *parent* which is the first vertex of a shortest path from  $v$  to the root. Given a rooted tree  $T$ , one can hence design an algorithm that starts from the leaves of  $T$  and continue by decreasing distance to the root of  $T$ .

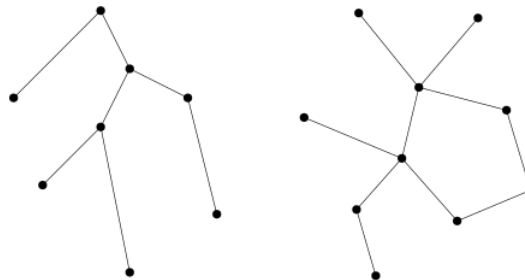

Figure 1.9: On the left-hand side, a tree with 4 leaves; on the right-hand side a graph which is not a tree as it contains a  $C_5$ .

In a tree, there is a simple relation between the number of vertices, and the number of edges.

**Proposition 1.2.1.** *Let  $T$  be a tree. Then  $n(T) = m(T) + 1$ .*

Since a non-empty forest always has a vertex of degree at most 1, and as any subgraph of a forest is also a forest, we directly have that a forest is 1-degenerate. In fact, this is a characterization of the class of forests. It is easy to see that if all the vertices of a graph  $G$  have degree at least two, then  $G$  contains a cycle. Note that any connected graph  $G$  has a *spanning tree*, *i.e.*, a tree with the same vertex set of  $G$ . Again, from an algorithmic point of view, it is often convenient to first consider a spanning tree of a graph to extract a partial ordering on the vertices.

### 1.2.2 Embeddings, drawings and planar graphs

In this section, we introduce one of the most famous, and thus studied class of graphs: planar graphs. We first need some elementary geometrical and topological notion to define this class of graphs. As it is irrelevant for this thesis, we will not present here the details needed to formally define this class of graph from a non-combinatorial point of view.

A *curve* is the image of the unit interval  $[0, 1]$  by a continuous mapping  $\psi$  to the Euclidean plane  $\mathbb{R}^2$  injective on  $]0, 1[$ ; it is intuitively a line drawn in the plane between two points “without lifting the pen” such that the line does not intersect itself. If  $C$  is a *curve* between two points  $x$  and  $y$ , the set  $C \setminus \{x, y\}$  is called the *interior* of  $C$ , and  $x$  and  $y$  are the *endpoints* of  $C$ . A *plane graph* is an ordered pair  $(V, E)$  where  $V$  is a set of points of  $\mathbb{R}^2$  called the vertices, and  $E$  is a set of *curves* connecting pairs of vertices of  $V$  such that the *interiors* of the curves are pairwise disjoint (*i.e.* the curves are not crossing), and each curve does not contain any vertex except its endvertices. A *plane graph*  $\hat{G} = (\hat{V}, \hat{E})$  yields naturally a graph  $G = (V, E)$ , and a bijective mapping  $\varphi$  that maps the vertices (respectively the edges) of  $\hat{G}$  to the vertices (respectively the edges) of  $G$ . Such a graph  $G$  is called a *planar graph*, and  $\varphi$  is a *planar embedding* of  $G$ , while  $\hat{G}$  is a *drawing* of  $G$ . When there is no ambiguity, we will use  $G$  to denote both the graph and the plane graph. Note that a planar graph may admit different embeddings.

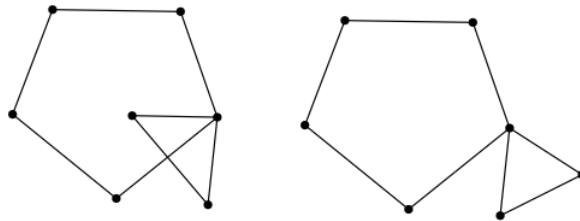

Figure 1.10: On the right-hand side, a planar graph with a planar embedding; on the left-hand side, the same planar graph with a non-planar embedding.

Let  $\hat{G} = (\hat{V}, \hat{E})$  be a plane graph, the set  $\mathbb{R}^2 \setminus (\hat{V} \cup \hat{E})$  is composed of one or more maximal connected regions, each of these regions is called a *face* of  $\hat{G}$ . Since  $\hat{G}$  is bounded, there is a unique *face* of  $\hat{G}$  which is unbounded, this face is called the *outerface* of  $\hat{G}$ , all the other faces of  $G$  are called its *innerfaces*. We denote by  $F(G)$  the set of the faces of  $G$ , and by  $f(G)$  (or simply  $f$  when there is no ambiguity) the cardinality of this set. Note that  $F(G)$  is a natural *cycle base* of  $G$ . The set of vertices and edges which are in contact with some face  $f_0$  of a planar graph  $G$  is called the *boundary* of  $f_0$  (we say that  $f_0$  is bounded by this set).

Two faces are called *adjacent* if they share at least one edge on their boundary. Note that if  $G$  is a plane graph, any cycle is a closed curve that separates the plane into two parts. If a cycle is also a separator of the planar graph, the cycle is called a *separating cycle*. Note that a *forest*, regardless of its embedding, only has one face, its outerface. If  $G$  is a *2-connected* planar graph, then each face is bounded by a cycle of  $G$ .

A planar graph  $G$  is called *outerplanar* if it admits a planar embedding where each vertex lies on the *outerface*. A graph  $G$  is called a *triangulation* if each of its faces is bounded by a triangle; if all the faces but the outerface are bounded by triangles, then  $G$  is called a *near-triangulation*. A planar graph  $G$  is *maximal* if adding any new edge to  $G$  makes it non-planar. Note that a *maximal* planar graph on 3 vertices or more is a triangulation.

Let  $G$  be a planar graph with a given planar embedding. The *dual graph* of  $G$  is a (multi)graph  $G^*$  (with possibly *loops*) with vertex set  $V(G^*) = F(G)$ , and such that two vertices of  $G^*$  are connected if the two corresponding faces of  $G$  in the given embedding are adjacent. Depending on the embedding of  $G$ , the graph can have different non-isomorphic *dual graph*. However, if a graph  $G$  is sufficiently *connected*, then a result of Whitney [Whi33] guarantees that all the drawings of  $G$  are isomorphic up to the choice of the outerface.

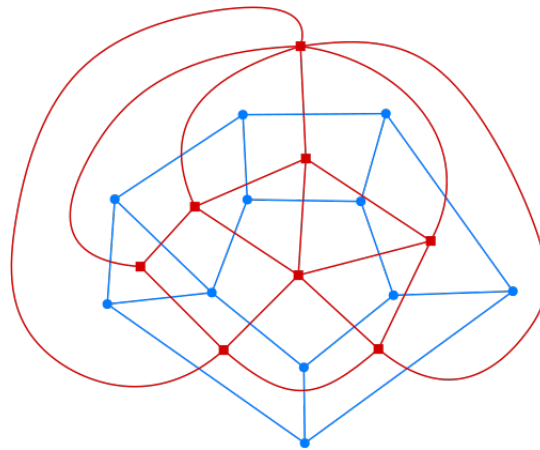

Figure 1.11: The blue graph is a 3-connected planar graph, and the red graph is its dual graph.

**Theorem 1.2.2** ([Whi33]). *A 3-connected planar graph admits a unique embedding in the plane up to equivalence.*

A simpler proof translated in the language of modern graph theory was also recently given by Brinkmann[Bri20]. From this result, we hence also have the unicity of the *dual graph* of a 3-connected planar graph.

Let  $G$  be a 3-connected planar graph. The dual graph  $G^*$  is also planar, and the graph  $G$  is called the *primal graph* of  $G^*$ . Note that the dual of  $G^*$  is the graph  $G$  itself, and that if  $G$  is a simple 3-connected planar graph, then  $G^*$  is also a simple graph.

As mentioned above, planar graphs were originally defined using geometric properties. However, Kuratowski found a purely combinatorial way to characterize planar graphs as a class of graphs forbidding some subdivisions of a set of graphs.

**Theorem 1.2.3** (Kuratowski). *Let  $G$  be a graph. Then  $G$  is planar if and only if it does not contain  $K_5$  nor  $K_{3,3}$  as a subdivision.*

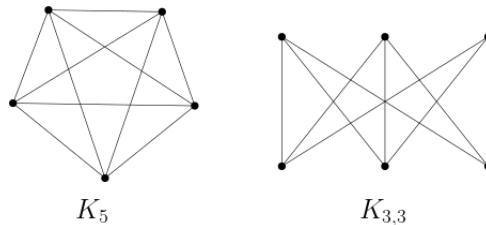

Figure 1.12: The two graphs whose subdivisions are obstruction to planarity.

Euler proved in the 18<sup>th</sup> century a fundamental relation between the number of vertices, edges and faces in a planar graph.

**Theorem 1.2.4** (Euler's formula). *Let  $G$  be a connected planar graph. Then,  $n(G) - m(G) + f(G) = 1$ .*

To prove this formula, it suffices to consider a spanning tree  $T$  of a planar graph  $G$ . From Observation 1.2.1, we have that  $n(T) - m(T) = 1$ . We then add the edges of  $G \setminus T$  to  $T$  one by one: each edge added increases the number of faces by one. From this formula, we can directly conclude that planar graphs are 5-degenerate.

**Observation 1.2.5.** *Any planar graph is 5-degenerate.*

Indeed, let  $G$  be a planar graph with all the vertices having degree at least 6. We have that  $6 \cdot n(G) \leq 2 \cdot m(G)$ , thus  $m(G) - 3 \cdot n(G) \geq 0$ . Since the faces have a size of at least 3, we also have that  $3 \cdot f(G) \leq 2 \cdot m$ . By Euler's formula, we have that  $f(G) = m(G) - n(G) + 1$ , hence,  $3 \cdot (m(G) - n(G) + 1) \leq 2 \cdot m(G)$ , so  $m(G) - 3 \cdot n(G) + 3 \leq 0$ , which leads to a contradiction as  $m(G) - 3 \cdot n(G)$  is non-negative.

## 1.3 Graph coloring

In this section we present one of the most common problems in graph theory: graph coloring.

### 1.3.1 Definitions and basic properties

Given a graph  $G$ , a  $k$ -coloring is a partition of the vertex set  $V$  of  $G$  into  $k$  sets  $V_1, \dots, V_k$ , such that each  $V_i$  is a **stable set**.

Equivalently, a  $k$ -coloring of  $G$  is a mapping  $\varphi$  that maps the vertices of  $G$  to the set of integer  $\{1, \dots, k\}$  such that for any edge  $uv$  of  $G$ ,  $\varphi(u) \neq \varphi(v)$ . Each integer  $i$  is called a **color**, and the set of vertices  $\varphi^{-1}(i)$  is called a **color class**. Any graph  $G$  has an  $n$ -coloring (each vertex receives a different color), thus the usual goal is to find the minimum integer  $k$  such that  $G$  admits a  $k$ -coloring – such an integer is called the **chromatic number** of  $G$  and is denoted by  $\chi(G)$ .

A trivial lower bound for the **chromatic number** is the **clique number**. If  $G$  is a graph with  $\omega(G) = k$ , then  $\chi(G) \geq k$  as we have to give to each vertex of the clique of size  $k$  in  $G$  a different color. Moreover, as each **color class** is a **stable**, we also have that  $\chi(G) \geq \frac{|V(G)|}{\alpha(G)}$ . There is also a natural relation between the maxi-

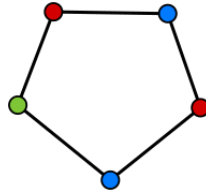

Figure 1.13: A  $C_5$  with a proper vertex-coloring.

imum degree of a graph  $G$  and its chromatic number. A simple coloring algorithm would consist in taking an ordering on the vertices  $(v_1, \dots, v_n)$ , and coloring the vertices one by one, following this ordering, with the smallest available color. A color  $c$  is **available** for a vertex  $v$  if no neighbor of  $v$  is already colored  $c$ . This algorithm is called a **greedy algorithm**, and yields an upper bound on the **chromatic number** of a graph. Given a graph  $G$ , since each vertex of  $G$  has only at most  $\Delta(G)$  neighbors, at most  $\Delta(G) + 1$  colors are needed to guarantee an available color for each vertex. If  $G$  is a  $k$ -**degenerate** graph, and  $(v_1, \dots, v_k)$  is the degeneracy order of  $G$ , we can color the vertices in the reverse order to obtain a  $(k + 1)$ -coloring of  $G$ . Indeed, each vertex  $v_i$  has degree at most  $k$  in  $G \setminus \bigcup_{j < i} v_j$ , so it has at most  $k$  neighbors already colored when following the reverse of the degeneracy order. Note that the degeneracy bound is far from optimal in most of the cases. When  $k$  is at least 3, it is however NP-Hard to compute the **chromatic**

number of a graph, and thus there is little hope to find a polynomial algorithm that computes the chromatic number in the general case.

The definition of coloring given above is actually the definition of **proper coloring**. Some other variants of coloring also exist, it may not be required to partition the vertices into **stable sets**. For instance the vertices can be partitioned into trees, or  $k$ -degenerate graphs. However, in this thesis, we only consider **proper colorings**, and thus we will drop the “proper” most of the time.

### 1.3.2 Coloring the edges

The problem of graph coloring can be naturally generalized to the edges of a graph  $G$ : we color the edges such that no two adjacent edges receive the same color. Equivalently, coloring the edges of  $G$  corresponds to coloring the vertices of  $L(G)$ . The minimum number of colors needed to color the edges of a graph  $G$  is called the **chromatic index** of  $G$ , and is denoted by  $\chi'(G)$ .

Let  $G$  be a graph, the structure of line graphs guarantees that  $\omega(L(G)) = \Delta(G)$ , and thus that  $\chi'(G) \geq \Delta(G)$ . Moreover, we also have that  $\Delta(L(G)) = 2 \cdot (\Delta(G) - 1)$ . This directly implies that, using a **greedy algorithm**, we can color the edges of  $G$  with at most  $\Delta(L(G)) + 1 = 2 \cdot \Delta(G) - 1$  colors. So we have that  $\chi'(G) \leq 2 \cdot \Delta(G) - 1$ , but this bound is pretty far from the optimal. Vizing proved in [Viz64] in his seminal paper on edge-coloring that one can color the edges of a graph with at most one more color than the lower bound. This leaves only two possibilities for  $\chi'(G)$ :  $\Delta(G)$  or  $\Delta(G) + 1$ .

**Theorem 1.3.1** ([Viz64]). *Let  $G$  be a graph, then  $\chi'(G) \leq \Delta(G) + 1$ .*

The class of **line graphs**, denoted by  $\mathcal{L}(G)$ , is the class of graphs that are the **line graph** of a graph. The structure of line graphs is significantly constrained: around each vertex, the edges containing this vertex are all pairwise adjacent, thus, a line graph consists of a set of **cliques** pairwise sharing at most a vertex. Beineke proved [Bei70] that the class of **line graphs** can equivalently be characterized by a set of forbidden **induced subgraphs**.

**Theorem 1.3.2** ([Bei70]). *A graph  $G$  is a line graph if and only if  $G$  does not contain as induced subgraph one of the following 9 graphs.*

Despite the fact that only two values are possible for the chromatic index of a graph, similarly to vertex-coloring, it is NP-Hard to compute it, even for cubic graphs [Hol81].

### 1.3.3 Basic results

As mentioned in the Section 1.3.1, computing the chromatic number of a graph is NP-Hard, thus we often focus on some specific classes of graphs. One of the

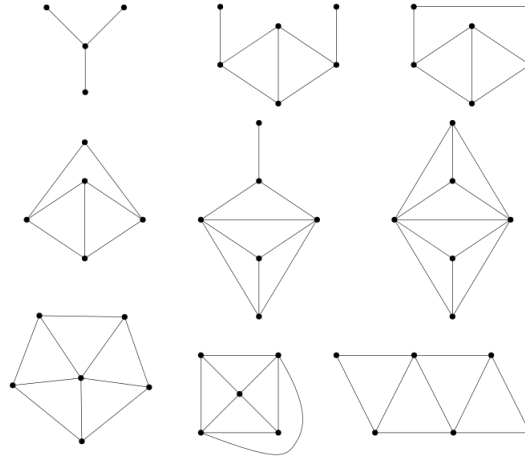

Figure 1.14: The 9 minimum graphs that cannot be induced subgraphs of a line graph.

most basic class of graph to consider when coloring a graph is the class of **forests** (or simply the class of **trees** as coloring can be handled componentwise). It is easy to see that a tree  $T$  is 2-colorable, it suffices to color the root of  $T$  with color 1 and its children with color 2 and so on until we have colored all the vertices of  $T$ .

A graph which is 2-colorable is a **bipartite graph** (recall that a 2-coloring is equivalent to a partition of the vertices into 2 **stable sets**). The **complete bipartite** graph (or **biclique**) with vertex set  $X \cup Y$  (where  $X$  and  $Y$  partition the set of vertices) is the graph where every vertex of  $X$  is connected to all the vertices of  $Y$  and vice versa; it is denoted by  $K_{|X|,|Y|}$ . There is a characterization of bipartite graphs based on the length of the cycles in the graph.

**Proposition 1.3.3.** *A graph  $G$  is bipartite if and only if  $G$  does not contain any odd cycle.*

*Proof.* Since an odd cycle cannot be 2-colored, it is clear that  $G$  cannot contain any odd cycle. Conversely, if  $G$  does not contain any odd cycle, then we consider a spanning tree  $T$  of  $G$  that we root at a vertex  $r$  of  $G$ . We consider a 2-coloring  $\varphi$  of  $T$ , and we show that  $\varphi$  is also a proper 2-coloring of  $G$ . If it is not the case, then there is a monochromatic edge  $uv$  in  $G$  (which is not in  $T$ ). Let  $P_{uv}$  be a shortest path in  $T$  from  $u$  to  $v$ , as  $u$  and  $v$  have the same color, the length of  $P_{uv}$  is even, but this means that  $P_{uv} \cup \{uv\}$  is an odd cycle in  $G$ , a contradiction.  $\square$

It is easy to see that one needs at least 3 colors to color any odd cycle, and at least  $k$  colors to color  $K_k$ . One of the most fundamental theorems on graph coloring is undoubtedly Brooks theorem published in 1941; he proved that these are the only cases where a graph  $G$  is not  $\Delta(G)$ -colorable.



**Theorem 1.3.4** (Brooks theorem [Bro41]). *Let  $G$  be a connected graph. If  $G$  is not a complete graph or an odd cycle, then  $\chi(G) \leq \Delta(G)$ .*

Note that from now on, when considering graph coloring, we only consider connected graphs since coloring can be handled componentwise. There are multiple proofs of this theorem in the literature (see [CR15] for a nice survey of Brooks theorem proofs), but Vizing and Melnikov [MV69] published a proof in 1969 based on a key concept in graph coloring: **Kempe chains** (we present this notion, central in this thesis, in Section 1.4: Kempe chains are essentially used to modify a partial coloring by recoloring some vertices in order to make a color **available** for a vertex).

As mentioned in the previous section, Vizing also proved, four years before, an upper bound for line graphs, or, equivalently, an upper bound for the chromatic index of a graph: for any graph  $\chi'(G) \leq \Delta(G) + 1$ . Vizing generalized one year later this result to multigraphs. Given a graph  $G$ , we denote by  $\mu(G)$  the maximum multiplicity of an edge of  $G$ , *i.e.*, the maximum number of edge between a pair of vertices.

**Theorem 1.3.5** ([Viz65a]). *Let  $G$  be a multigraph. Then  $\chi'(G) \leq \Delta(G) + \mu(G)$ .*

The proof of this last result essentially relies on the same arguments as the proof for simple graphs. The key tool of the proof is again **Kempe chain**, and since this thesis has a focus on edge-coloring, we will present the proof (for simple graphs) in Section 1.4.

### 1.3.4 Coloring planar graphs

The results presented in the previous section are all based on **Kempe chains**. This is also the case of the celebrated four-color theorem. This theorem states that any planar graph can be properly colored with only four colors. The real interest of this theorem lies less in its statement than in the fact that its proof required new and innovative tools, in particular the Kempe chains, and the discharging argument. Both these concepts became fruitful tools in graph coloring, and in graph theory in general. We will not discuss the later, and we refer the reader to [CW17] for a nice guide on the discharging method. We will however discuss the concept of Kempe chains more in detail in Section 1.4.

**Theorem 1.3.6** (four-color theorem, [AH76]). *Every planar graph is 4-colorable.*

As mentioned in Section 1.2.2, since planar graphs are 5-degenerate, planar graphs are 6-colorable using a **greedy algorithm** following the degeneracy order. It is also quite easy to prove that 5 colors are sufficient to color the vertices of a planar graph; however filling the gap between 5 and 4 remained one of the most

challenging questions in graph theory for decades. We describe in detail the story and one of the key arguments of the proof of this theorem in Section 1.4. This proof was the first use of Kempe chains to bound the number of colors needed to color the vertices of a graph.

Note that not all results on graph colorings are based on Kempe chains. *List-coloring* is a variant of proper coloring where each vertex of the graph is a priori given a list of available colors called a *list assignment*. Given a list assignment  $L$  of the vertices of a graph  $G$ ,  $G$  is called  $L$ -colorable if it is properly colorable such that each vertex is given a color in its own list of available colors. A graph is called  *$k$ -choosable* if it is  $L$ -choosable for any list assignment  $L$  where the lists have size at least  $k$ . It is clear that if a graph  $G$  is  $k$ -choosable, then it is also  $k$ -colorable as it suffices to assign to each vertex the same list of available colors.

One of the first results on vertex-coloring of planar graphs was that planar graphs are 5-colorable, and this proof relies on Kempe chains. An independent proof of this result (which does not use Kempe chains) was given by Thomassen in [Tho94], as he proved that planar graphs are 5-choosable.

**Theorem 1.3.7** ([Tho94]). *Let  $G$  be a planar graph, then  $G$  is 5-choosable.*

The proof of this theorem is particularly interesting as it is one of the first results on coloring of planar graphs that does not rely on Kempe chains nor the degeneracy order of the graph. The proof is a simple and elegant induction on the number of vertices, and the key argument is based on the embedding of the graph in the plane.

To color planar graphs, it is sometimes more convenient to translate the problem of vertex-coloring to a problem of edge-coloring of the *dual graph*. This is the first step of the proof of the four-color theorem. We present here the reduction from a 4-vertex-coloring of a triangulation  $G$  to a 3-edge-coloring of its dual graph  $G^*$ . We generalize this reduction in Section 4.1.

We omit the details here, but we can actually prove that it suffices to prove the 4-color theorem for 3-connected planar graphs. This is convenient since by Theorem 1.2.2, if  $G$  is a 3-connected planar graph, then it has a unique *dual graph*. Moreover, it is also easy to see that it suffices to prove it for triangulations. Indeed if  $G$  is a planar graph, we can add edges to  $G$  until we obtain a triangulation  $G'$ : if  $\varphi$  is a 4-coloring of  $G'$ , then  $\varphi$  is also a 4-coloring of  $G$ . Note that as  $G'$  only contains triangles, its dual graph  $G'^*$  is *cubic*.

**Proposition 1.3.8.** *Let  $G$  be a 3-connected triangulation. Finding a 4-vertex coloring of  $G$  is equivalent to finding a 3-edge coloring of  $G^*$ .*

*Proof.* Let  $\varphi$  be a 4-vertex-coloring of  $G$  with color set  $\{1, 2, 3, 4\}$ , we show that  $\varphi$  yields a 3-edge-coloring of  $G^*$ . We will partition the edges of  $G$  into 3 sets  $A, B, C$  in the following way: For any edge  $uv$  of  $G$ ,

- we put  $uv$  in  $A$  if  $\{\varphi(u), \varphi(v)\} \subseteq \{\{1, 2\}, \{3, 4\}\}$ ,
- in  $B$  if  $\{\varphi(u), \varphi(v)\} \subseteq \{\{1, 3\}, \{2, 4\}\}$ , and
- in  $C$  if  $\{\varphi(u), \varphi(v)\} \subseteq \{\{1, 4\}, \{2, 3\}\}$ .

Each edge  $e$  of  $G$  corresponds to an edge  $e^*$  of  $G^*$ , and we consider the edge coloring  $\varphi^*$  with color set  $\{a, b, c\}$  of  $G$  in the following way: For any edge  $e^*$  of  $G^*$  corresponding to an edge  $e$  of  $G$ :

- $\varphi^*(e^*) = a$  if  $e \in A$ ,
- $\varphi^*(e^*) = b$  if  $e \in B$ , and      (\*)
- $\varphi^*(e^*) = c$  if  $e \in C$ .

It remains to prove that  $\varphi^*$  is a proper edge-coloring of  $G^*$ . As  $G$  is a triangulation, the graph  $G^*$  is cubic, and each vertex of  $G^*$  correspond to a triangle in  $G$ . Let  $f = u_1u_2u_3$  be a triangle of  $G$  that corresponds to a vertex  $f^*$  of  $G^*$ . By definition of  $\varphi$ , the 3 vertices  $u_1, u_2, u_3$  have a different color, and without loss of generality, we may assume that  $\varphi(u_i) = i$  for any  $i$ . The edge  $u_1u_2$  is in  $A$ , the edge  $u_2u_3$  is in  $C$  and the edge  $u_1u_3$  is in  $B$ , thus the corresponding edges in  $G^*$  are respectively colored  $a, c$ , and  $b$ .

Conversely, let  $\varphi^*$  be a 3-edge-coloring of  $G^*$  with color set  $\{a, b, c\}$ . Let  $v$  be a vertex of  $G$  and  $T$  a spanning tree of  $G$  rooted in  $v$ . We build a vertex-coloring  $\varphi$  of  $G$  in the following way:

- we first give the color 1 to the vertex  $v$ ,
- then we traverse the tree from the root to the leaves, and we give to each vertex  $v$  a color depending on the color of its parent  $v'$  and the color of the edge  $vv'$  using the reciprocal of the rules described in (\*).

It is easy to see that the vertex-coloring  $\varphi$  is a proper vertex coloring of  $G$ .     $\square$

Following from this reduction, Tait [Tai80] conjectured the following conjecture.

**Conjecture 1.3.9.** *Every cubic 3-connected planar graph has a [Hamiltonian cycle](#).*

If true, this conjecture would directly imply the four color theorem. This conjecture essentially says that if a graph is the [dual](#) of a 3-connected [triangulation](#) (i.e. a cubic 3-connected planar graph), then we can build a 4-vertex coloring of the dual of this graph. Let  $G$  be a 3-connected triangulation, since every face of  $G$  has an odd number of edges, we can easily prove by a counting argument that

$G$  has an even number of faces, and thus that  $G^*$  has an even number of vertices. If  $G^*$  has an Hamiltonian cycle  $C$ , then we can build a 3-edge coloring of  $G^*$  in the following way: we color alternatively the edges of  $C$  with the colors  $a$  and  $b$  (since  $C$  is even, this coloring is proper). We color the remaining [matching](#) with color  $c$ , by Proposition 1.3.8 this edge-coloring yields a 4-vertex coloring of  $G$ .

Nevertheless this conjecture was disproved by Tutte who built a cubic 3-connected planar graph with no [Hamiltonian cycle](#). This graph is build by taking a  $K_4$  and replacing 3 of the vertices by the Tutte's fragment such that each top edge of the fragments are incident with the remaining vertex of the  $K_4$ . The fundamental property of this fragment is that if there is a path entering the fragment, spanning all the vertices of the fragment and leaving the fragment, then it has to contain the top edge. If Tutte's graph has an Hamiltonian cycle, then each fragment has a spanning path entering and exiting the fragment. This would imply that all the edges incident with the central vertex belong to the Hamiltonian cycle, a contradiction.

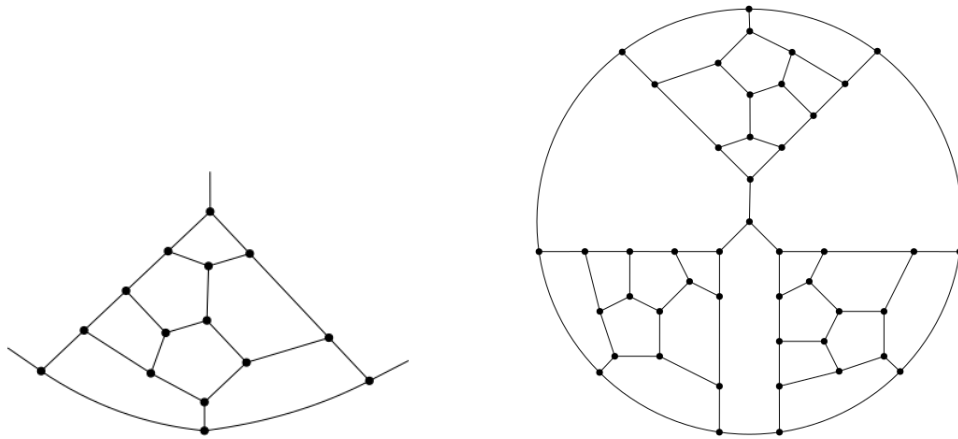

Figure 1.15: The Tutte's fragment and the Tutte's graph.

### 1.3.5 Graph minors and coloring

An important tool to study the structure of graphs is graph [minors](#). This notion was introduced in the eighties by Seymour et al. in a sequence of seminal papers on the structure of perfect graphs published between 1983 and 2012 (see [RS83, RS86a, RS84, RS90a, RS86b, RS86c, RS88, RS90c, RS90b, RS91, RS94, RS95a, RS95b, RS95c, RS96, RS03a, RS99, RS03b, RS04a, RS04b, RS09, RS12, RS10] for a complete list of this series). This notion has lead to fundamental results on the structural properties of graphs. A graph  $H$  is called a [minor](#) of a graph  $G$  if  $H$  can be obtained from  $G$  by:

- deleting edges,
- contracting edges or
- deleting isolated vertices.

Here, *contracting* an edge  $uv$  means merging the vertices  $u$  and  $v$  into a vertex  $x$  where  $N(x) = N(u) \cup N(v) \setminus \{u, v\}$ . Equivalently, a graph  $H$  is a minor of a graph  $G$  if one can find  $|V(H)|$  disjoint sets of vertices  $V_1, \dots, V_{|V(H)|}$ , such that for each  $i$ ,  $G[V_i]$  is connected, and such that the graph  $G'$  obtained from  $G$  by merging each  $G[V_i]$  into a vertex  $v_i$  admits  $H$  as a subgraph.

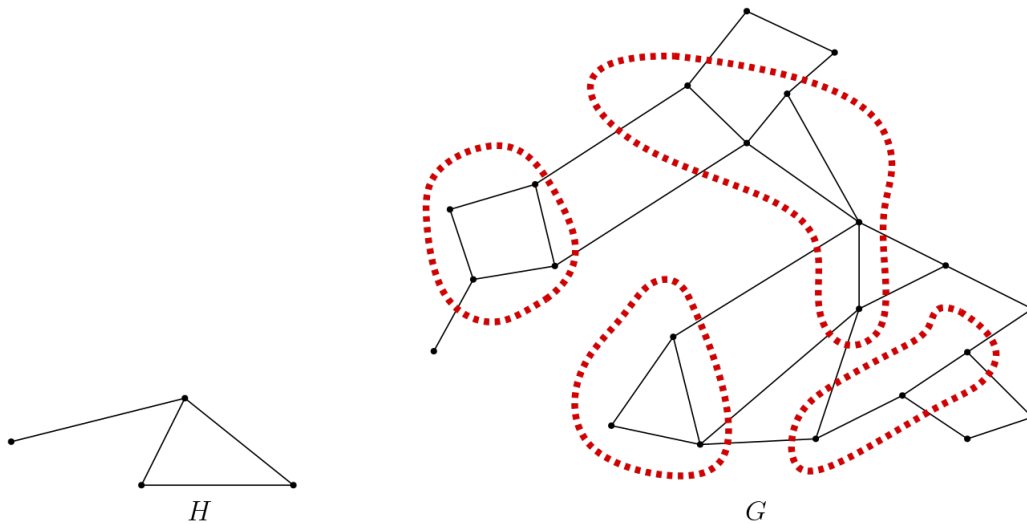

Figure 1.16: By merging the vertices in each red bag in the graph  $G$ , we obtain a graph such that  $H$  is a subgraph of  $G$ :  $H$  is a minor of  $G$ .

Robertson and Seymour proved in their series of papers that any class of graphs that is closed under minors (*i.e.* if a graph belongs to the class, then all its minors also belong to the class) can be characterized by a finite set of forbidden minors. This theorem is a direct consequence of the following theorem.

**Theorem 1.3.10.** *Graphs are well-quasi ordered for the minor relationship.*

There exists a strong relationship between the minors of a graph and its *chromatic number*. As mentioned in the previous section, planar graphs are exactly the graphs with no  $K_5$  nor  $K_{3,3}$  as minors. By the four-color theorem, planar graphs are all 4-colorable. The current proof of the four-color theorem is not satisfying as it needs a computer assistance to be checked. Several approaches were explored to have a better understanding of the link between planarity and the fact that 4 colors suffice, and graphs minors seem to be a particularly promising

one. It seems natural to exclude  $K_5$  as minor for 4-colorable graphs as  $K_5$  itself is not 4-colorable, however, what about  $K_{3,3}$ ? What if we drop the  $K_{3,3}$ -minor-free assumption? Are all  $K_5$ -minor-free graphs 4-colorable? Can we generalize it for the class of  $K_t$ -minor-free graphs for any value of  $t$ ? Hadwiger proposed the following conjecture in 1943.

**Conjecture 1.3.11** (Hadwiger’s conjecture). *Let  $G$  be a  $K_t$ -minor-free-graph. Then  $G$  is  $(t - 1)$ -colorable.*

Hadwiger proved in the same paper that the conjecture holds for the case  $t = 3, 4$  [Had43]. Nevertheless, this conjecture is still open for the cases  $t > 6$ , and is one of the most famous and studied conjecture in graph theory to this day. Wagner [Wag37] actually proved that the case  $t = 5$  is equivalent to the four-color theorem, and thus the case  $t = 5$  was finally proved when the four-color theorem was proved in 1976 by Appel and Haken. The case  $t = 6$  was proved by Robertson, Seymour and Thomas [RST93], but unfortunately their proof still relies on the four-color theorem. Asymptotically, the best known bound for decades was a result of Kostochka [Kos82], [Kos84], and independently Thomason [Tho84].

**Theorem 1.3.12.** *Every graph with no  $K_t$  minor is  $O(t\sqrt{\log(t)})$ -colorable.*

They actually prove a bound on the **degeneracy** of  $K_t$ -minor free graphs which implies Theorem 1.3.12.

**Theorem 1.3.13.** *Every graph with no  $K_t$ -minor is  $O(t\sqrt{\log(t)})$ -degenerate.*

As mentioned in Section 1.3.1, any  $k$ -degenerate graph is  $(k + 1)$ -colorable. Moreover, Kostochka [Kos82], [Kos84] and de la Vega [DLV83] proved that this bound on the degeneracy is tight, as they showed that there exist graphs with no  $K_t$  minor and with minimum degree  $\Omega(t\sqrt{\log(t)})$ . Recently, Delcourt and Postle [DP21] improved this bound; this is the current best known bound.

**Theorem 1.3.14.** *Every  $K_t$ -minor free graph is  $O(t \log \log(t))$ -colorable.*

### 1.3.6 Signed graphs and signed coloring

Signed graphs were invented in the context of socio-psychology to model relationships between people, however it turns out that it became an concept of its own interest from a graph theory point of view.

A **signed graph**  $\hat{G}$  is a pair  $(G, \sigma)$  where  $G$  is a graph called the **underlying graph**, and  $\sigma$  is a mapping, called the **signature** of  $\hat{G}$ , which maps the edges of  $G$  to the set  $\{-1, 1\}$ . The edges that are mapped to 1 are called the **positive**

*edges*, and the edges mapped to  $-1$  are called the *negative edges*. Let  $(G, \sigma)$  be a signed graph. There is a special operation allowed on each vertex of  $(G, \sigma)$  which changes  $\sigma$ : the *switching operation*. Switching a vertex  $v$  in  $(G, \sigma)$  consists in switching the sign of every edge incident with  $v$ . Note that when switching the vertex  $v$  twice, we obtain the original signature  $\sigma$ . Moreover, if  $u$  and  $v$  are two vertices of  $G$ , switching  $u$  before  $v$  or  $v$  before  $u$  gives the exact same signature in the end. Thus the switching operation induces an *equivalence* relation on signed graphs having the same *underlying graph*. Two signed graphs  $(G, \sigma_1), (G, \sigma_2)$  are called *equivalent* if one can find a set of vertices to switch such that switching these vertices transform the signature  $\sigma_1$  into the signature  $\sigma_2$ . In this thesis, we will not distinguish between signed graphs that are equivalent, and we consider that two signed graphs are equal if they have the same underlying graph and if their respective signature are equivalent.

When considering signed graphs, cycles have a particular importance. If  $C$  is a cycle of a signed graph  $\hat{G} = (G, \sigma)$ , we define the *sign* of  $C$  as the product of the sign of its edges, and we denote it by  $\sigma(C)$ . The sign of a cycle  $C$  is thus entirely determined by the number of its negative edges. If  $C$  has an even number of negative edges, then  $\sigma(C) = 1$ , and  $C$  is called a *balanced* cycle (or a *positive* cycle), and if  $C$  contains an odd number of negative edges, then  $C$  is called a *unbalanced* cycles (or *negative* cycle). Note that if a signed graph  $\hat{G}$  only has positive edges, we call  $\hat{G}$  a balanced signed graph. Zaslavsky proved [Zas82b] that the signature of a signed graph  $\hat{G}$  is entirely determined by the set of negative cycles in  $\hat{G}$ .

**Proposition 1.3.15** ([Zas82b]). *Let  $\hat{G} = (G, \sigma)$  and  $\hat{G}' = (G, \sigma')$  be two signed graphs with the same underlying graph. The signatures  $\sigma$  and  $\sigma'$  are equivalent if and only if the set of negative cycles in  $\hat{G}$  is the same as the set of negative cycles in  $\hat{G}'$ .*

This proposition is a direct consequence of the following proposition.

**Proposition 1.3.16.** *Let  $\hat{G} = (G, \sigma)$  be a connected signed graph, and  $T$  a spanning tree of  $G$ . The signature  $\sigma$  is equivalent to a signature  $\sigma'$  where for any edge  $e$  in  $T$ ,  $\sigma'(e) = 1$ .*

Coloring of signed graphs was first introduced by Zaslavsky in the early eighties in three seminal papers [Zas82b], [Zas82a], and [Zas84]. A proper signed  $k$ -coloring of a signed graph  $\hat{G}$  is a mapping from the set of vertices of  $\hat{G}$  to a set of  $k$  colors. Contrary to coloring of non-signed graph where colors can be any set of integers, when coloring a signed graph, the set of colors matters. Depending on the parity of  $k$ , the set of color will be  $\{-\lfloor \frac{k}{2} \rfloor, \dots, \lfloor \frac{k}{2} \rfloor\}$  if  $k$  is even, and  $\{-\lfloor \frac{k}{2} \rfloor, \dots, 0, \dots, \lfloor \frac{k}{2} \rfloor\}$  if  $k$  is odd. A coloring  $\varphi$  is a proper signed coloring  $\varphi$  of

a signed graph  $\hat{G} = (G, \sigma)$  if for any edge  $uv$  of  $G$ ,  $\varphi(u) \neq \sigma(uv) \cdot \varphi(v)$ . Hence, contrary to coloring non-signed graph, a negative edge can be monochromatic in a signed coloring.

Mačájová, Raspaud and Skoviera [MRŠ16] continued the work of Zaslavsky and defined the *chromatic number* of a signed graph  $\hat{G}$  as the natural generalization of the *chromatic number* of non-signed graphs, *i.e.* as the minimum  $k$  such that  $\hat{G}$  admits a proper signed  $k$ -coloring. Hence, coloring a balanced signed graph is equivalent to non-signed proper coloring.

Interestingly, several results on coloring non-signed graphs can be generalized to signed graphs in a pretty natural way. In particular, for the case of planar signed graphs (in this thesis, we only focus on planar signed graphs and we will not detail results on non-planar signed graphs), Mačájová, Raspaud and Skoviera [MRŠ16] proved that planar signed graphs are 5-signed colorable (the proof of Thomassen of 5-choosability of planar graphs can even easily be adapted to signed graphs); they also proved that triangle-free planar signed graphs are 3-colorable, thus generalizing to signed graphs Grötzsch's theorem. They conjectured that the four-color theorem could also be generalized to signed graphs. If true, this would have given a new approach for proving the four-color theorem: a key concept of the proof of the four-color theorem, namely *Kempe chains*, cannot be easily adapted to signed graphs due to the existence of monochromatic edges in signed coloring. However, we disprove this conjecture in Section 4.1.



## 1.4 Graph coloring reconfiguration: Kempe chains

In this section we discuss one fruitful tool in graph coloring: [Kempe chains](#).

### 1.4.1 Preliminaries

As seen in Section 1.3.1, [greedily](#) coloring a graph yields a coloring with at most  $\Delta + 1$  colors. However, in most of the cases, this is far from optimal: Brook's theorem guarantees that only [cliques](#) and odd cycles need that many colors. Furthermore, there exist very simple [classes](#) of graphs with unbounded degree, and constant chromatic number. A basic example is the [class](#) of stars. A [star](#) consists of an independent set of vertices, all connected to a central vertex. Any star can have an arbitrary high maximum degree, but is trivially 2-colorable. It suffices to give color 1 to the independent set, and color 2 to the central vertex; this does not depend on the number of vertices in the independent set, and thus does not depend on the degree of the central vertex, which is also the maximum degree of the star.

However, given an optimal coloring  $\varphi$ , it is easy to find an optimal coloring  $\varphi'$  that yields an ordering on the vertices such that [greedily](#) coloring the vertices following this ordering gives the optimal coloring  $\varphi'$ . The coloring  $\varphi'$  must verify the following property: if a vertex  $v$  is colored with color  $k$ , then for any color  $i$  smaller than  $k$ ,  $v$  must be adjacent to a vertex colored  $i$ . Starting from the coloring  $\varphi$ , the coloring  $\varphi'$  can be built by successively decreasing the color of the vertices to the smallest color not in their neighborhood, starting with the vertices colored with color 2, then the vertices colored with color 3 and so on. The ordering emerges then naturally from  $\varphi'$ : we first take all the vertices colored 1, then all the vertices colored 2 ... etc.

Nevertheless, trying to find an optimal ordering on the vertices is not a viable approach to find an optimal coloring. Another way to find an optimal coloring is to [greedily](#) color the vertices of the graph (following the ordering induced by its degeneracy for instance), and “locally” transform the partial coloring when encountering a deadlock in the greedy algorithm (*i.e.* trying to color a vertex that is already adjacent to all the available colors). The aim of the modification is to make a color [available](#) for the vertex to be colored by recoloring one or several of its neighbors in such a way that, after the modification, the partial coloring is still a proper partial coloring of the graph.

The concept of [Kempe chains](#) was invented by Alfred Kempe in the 19<sup>th</sup> century when attempting to prove the four-color theorem. The journey of this theorem is central in the history of graph coloring. Everything starts in 1852 when

Francis Guthrie realized that four colors suffice to properly color a map of the counties of England (*i.e.* two counties sharing a border do not receive the same color). Guthrie conjectured that for any map, 4 colors were always sufficient, and his brother, Peter Guthrie, went to his former advisor, Augustus De Morgan, and asked if he can find a proof of this fact.

By representing each county by a vertex, and connecting two vertices with an edge if the two corresponding counties share a border, this conjecture can be translated in the modern language of graph theory as follows:

**Conjecture 1.4.1.** *Every planar graph is 4-colorable.*

This conjecture remained unproved until 1879 when Alfred Kempe proposes a proof of the four-color theorem [Kem79]. However it turned out that his proof was false. Eleven years later, Heawood builds a counter-example to Kempe's proof [Hea90], but was able to prove that 5 colors are always sufficient to properly color the vertices of a planar graph using the central tool used in Kempe's proof: [Kempe chains](#). The first correct proof of the four-color theorem was given in 1976 by Appel and Haken [AH76], the proof is a computer-assisted proof that heavily relies on the use of [Kempe chains](#). Note that a more recent proof of the four-color theorem was published in 1997 by Robertson, Seymour, Sanders and Thomas. This new proof relies on the same principles as the proof of 1976, but is much simpler and accessible, the authors even give the source code of the program needed to check it.

## 1.4.2 Kempe chains and Kempe swaps

As mentioned above, one of the central concept of these proof is [Kempe chain](#). [Kempe chains](#) are a tool to “locally” change a coloring to make a color available for a vertex. Given a graph  $G$ , a  $k$ -coloring  $\varphi$ , and a pair of colors  $a$  and  $b$ , we consider the graph  $K(a, b)$  induced by the set of vertices of  $G$  colored  $a$  or  $b$ . A [Kempe chain](#) is a connected component of  $K(a, b)$ . Equivalently, a [Kempe chain](#) is a maximal bichromatic component of  $G$ . Note that the term “chain” can be misleading as a Kempe chain can be any connected bipartite graph. Let  $K$  be a [Kempe chain](#) of  $G$  involving the colors  $a$  and  $b$ , applying a [Kempe swap](#) (in the literature, the terms Kempe change or Kempe exchange are also used) on  $K$  consists in switching the colors of the vertices in  $K$  (*i.e.* all the vertices colored  $a$  are recolored  $b$  and vice versa). Note that, since the component  $K$  is maximal, the coloring  $\varphi'$  obtained after the swap is still a proper coloring. If the component  $K$  does not span all the vertices colored  $a$  or  $b$  in  $G$ , then the coloring  $\varphi'$  is different from the coloring  $\varphi$  in the sense that the partition of the vertices of  $G$  is different; otherwise, swapping the component only consists in renaming the colors. Note that swapping twice the same Kempe chain does not change the

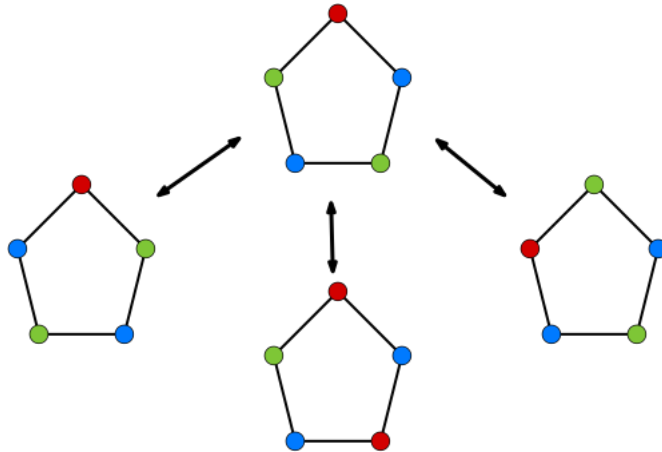

Figure 1.17: Different Kempe swaps applied on a 3-coloring of a  $C_5$ .

coloring. Moreover, a Kempe swap can also be applied on a partial coloring, and thus transform a proper partial coloring into another proper partial coloring.

Given a partial coloring, one can thus apply Kempe swaps on this coloring to make a color  $c$  available for a vertex  $v$  (i.e. to change the coloring in such a way that no neighbor of  $v$  is colored with  $c$ ). To illustrate this principle, we present here the proof of the five-color theorem.

**Theorem 1.4.2** (Heawood, [Hea90]). *Every planar graph is 5-colorable.*

*Proof.* Let  $G$  be a planar graph given with a planar embedding. By Observation 1.2.5, the graph  $G$  is 5-degenerate, so there exists an ordering  $(v_1, \dots, v_n)$  on the vertices of  $G$  such that if we color the vertices of  $G$  following this ordering, each uncolored vertex has at most 5 neighbors that are already colored. Assume that we have already colored all the vertices up to  $v_{i-1}$ , we now want to give a color to  $v_i$ . If some color does not appear in the neighborhood of  $v_i$ , then we can color  $v_i$  with that color. Otherwise, it means that all the five colors appear in the neighborhood of  $v_i$ , up to renaming the colors, we assume that the already colored vertices  $u_1, \dots, u_5$  around  $v_i$  are respectively colored with colors 1,  $\dots$ , 5 in the clockwise order.

Our goal is now to use Kempe swaps on the Kempe chains containing the vertices  $u_j$  to free a color for  $v_i$ . We first consider the component of  $K(1, 3)$  containing  $u_1$ . If  $u_3$  does not belong to the same Kempe chain, then we can swap the component containing  $u_1$  to obtain a coloring where both  $u_3$  and  $u_1$  are colored 3, we can now color  $v_i$  with color 1. So  $u_3$  and  $u_1$  are in the same component of  $K(1, 3)$ , hence there is a path  $P_{1,3}$  between these two vertices, and this path only contains vertices colored 1 or 3. We now consider the component

of  $K(2, 4)$  containing the vertex  $u_2$ ; with the same reasoning there is a path  $P_{2,4}$  in  $G$  between  $u_2$  and  $u_4$  which only consists of vertices colored 2 or 4.

This means that the paths  $P_{1,3}$  and  $P_{2,4}$  cross. As they do not share any color, they cannot have a vertex in common, and since  $G$  is planar, the edges do not cross either; a contradiction.

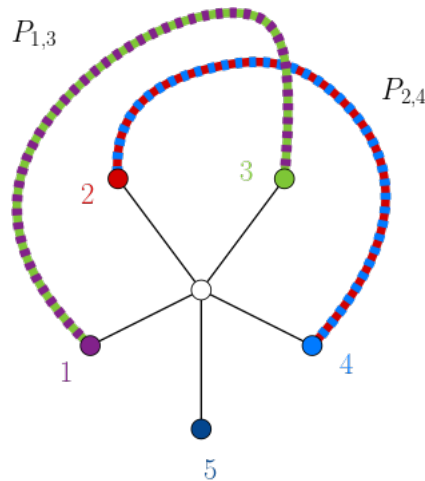

Figure 1.18:  $P_{1,3}$  and  $P_{2,4}$  cannot share a vertex, so there is an edge crossing; a contradiction since  $G$  is planar.

□

Unfortunately, this argument cannot be straightforwardly generalized to the case with only 4 colors. We give here one of the two smallest planar graphs with a partial 4-coloring such that no single Kempe swap can free a color for the only uncolored vertex. This graph, and the failing partial coloring was found by Fritsche [Koc99]. Note that the failing partial coloring is not unique.

### 1.4.3 Kempe chains and edge-coloring

The concept of Kempe chains was invented in the context of vertex-coloring, however, it can be naturally generalized to edge-coloring as any edge-coloring of a graph  $G$  correspond to a vertex-coloring of  $L(G)$ . Furthermore, when considering edge-coloring, the Kempe chains have a much more constrained structure. Let  $G$  be a graph, and  $\varphi$  be an edge-coloring of  $G$ . Any edge of  $G$  is adjacent to at most 2 edges of a given color. A Kempe chain in an edge-coloring is thus a bipartite graph with maximum degree 2, which leads to only two possibilities: either the chain is a path, or the chain is an even cycle.

Hence Kempe swaps in edge-colorings are much more tractable than in vertex-coloring. In Section 1.3.3 we have seen that Vizing's theorem guarantees that

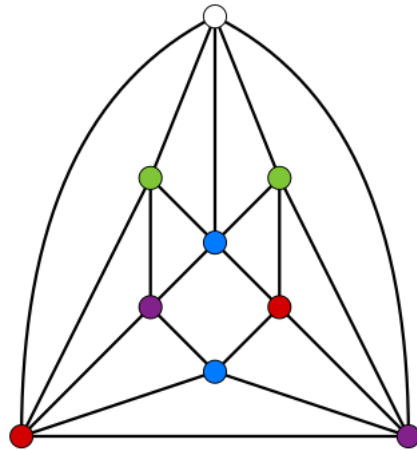

Figure 1.19: The Fritzsche graph with a partial coloring such that it is not possible to free a color for the white vertex using a single Kempe swap: a counter example to Kempe’s proof.

only  $\Delta(G) + 1$  colors are needed to properly color the edges of  $G$ . Vizing’s proof also heavily relies on Kempe swaps, and the key idea of the proof is some kind of overlay of Kempe swaps that allows very local and controlled changes in the coloring: Vizing’s fans. Two of the main results in this thesis are based on a deep analysis of these Vizing’s fan (see Chapter 2), thus we will here introduce this notion and present the proof of Vizing’s theorem.

Let  $G$  be a graph and  $\varphi$  a  $k$ -edge-coloring of  $G$  with  $k > \Delta(G)$ . As  $k$  is strictly bigger than the maximum degree of  $G$ , each vertex of  $G$  *misses* at least one color (*i.e.* for each vertex  $v$ , there is at least one color  $c$  such that no edge incident with  $v$  is colored  $c$ ). For each vertex  $v$  of  $G$ , we define the directed graph  $D_v$  as follows:

- the vertices of  $D_v$  are the edges of  $G$  incident with  $v$ ,
- we put an arc from a vertex  $vv_1$  to a vertex  $vv_2$  of  $D_v$  if the vertex  $v_1$  of  $G$  misses the color of  $vv_2$  in  $\varphi$ .

If  $v_1$  is a neighbor of  $v$ , a *fan* around  $v$  starting at the edge  $vv_1$  is a maximal subgraph of  $D_v$  of maximum outdegree 1 reachable from  $vv_1$ . The principle of Vizing’s fans is to allow a very local propagation of the changes in the coloring to free a color for an edge, and the proof of Vizing’s theorem nicely illustrate this principle.

*Proof.* Toward contradiction, assume that there exists a graph  $G$  that needs more than  $\Delta(G) + 1$  colors to be properly edge-colored. By a greedy argument, at

most  $2 \cdot \Delta(G) - 1$  are needed to color the edges of  $G$ . Let  $\varphi$  be a  $(2 \cdot \Delta(G) - 1)$ -edge-coloring of  $G$  that minimizes the number of edges colored with the color of maximum index among the edge-colorings that minimize the number of colors used, and let  $c$  be the color with the maximum index in  $\varphi$ . By assumption,  $c > \Delta(G) + 1$ , otherwise,  $G$  is  $(\Delta(G) + 1)$ -colorable, so each vertex of  $G$  misses at least 2 different colors (*i.e.* around a vertex  $v$ , at least 2 colors are not used to color the edges incident with  $v$ ). Let  $e = vv_1$  be an edge colored  $c$  in  $\varphi$ . Our goal is to use Kempe swaps to recolor this edge with a smaller color without increasing the total number of edges colored  $c$  in  $G \setminus \{e\}$ .

We now consider a fan  $X = (vv_1, vv_2, \dots, vv_k)$  around  $v$  starting at the edge  $vv_1$  such that no  $v_i$  is missing the color  $c$  (such a fan exists as each vertex misses at least 2 colors). Since  $X$  is maximal, there are only two possibilities:

- either  $v_k$  misses a color that is also missing at  $v$ , or
- $v_k$  misses the color of an edge  $vv_j$  for some  $j < k$ .

We first handle the first case. So  $v_k$  is missing a color  $c' < c$  which is also missing at the vertex  $v$ . This means that the component of  $K(c', \varphi(vv_k))$  containing the edge  $vv_k$  only consists of the edge  $vv_k$ , thus we can swap this component to obtain a coloring  $\varphi'$  where the edge  $vv_k$  is colored  $c'$  and where the vertex  $v$  is now missing the color  $\varphi(vv_k)$ . By definition of the fan  $X$ , the vertex  $v_{k-1}$  is missing the color  $\varphi(vv_k)$ , thus in the coloring  $\varphi'$ , the component of  $K(\varphi(vv_{k-1}), \varphi(vv_k))$  containing the edge  $vv_{k-1}$  consists only of the edge  $vv_{k-1}$ , hence we can swap it and obtain a coloring where the vertex  $v$  is missing the color  $\varphi(vv_{k-1})$  which is also a missing color at the vertex  $v_{k-2}$ . Therefore, we can apply a sequence of single-edge Kempe swaps on the edges of  $X$  to obtain a coloring where  $v$  and  $v_1$  are missing a common color  $c'' < c$  which can be used to color the edge  $vv_1$ . In the final coloring, the number of edges colored  $c$  has decreased by one which is a contradiction with the minimality of  $\varphi$ .

We now show that the second case can be reduced to the first one. So there exists some  $j < k$  such that the vertices  $v_k$  and  $v_j$  are missing the same color  $c' < c$ . We now consider a missing color  $c'' < c$  at the vertex  $v$ , and the component  $C$  of  $K(c', c'')$  containing  $v$ . As the vertex  $v$  is missing the color  $c''$ , the component  $C$  cannot be a cycle, thus it is a path. As  $C$  is a path that contains the vertex  $v$ , it cannot contain both the vertices  $v_k$  and  $v_j$  as both these vertices are missing the color  $c'$ . If  $v_j$  does not belong to  $C$ , then we can swap the component of  $K(c', c'')$  containing  $v_j$  to obtain a coloring where  $(vv_1, \dots, vv_j)$  is a fan around  $v$  starting at  $vv_1$  with  $v_j$  and  $v$  missing the same color  $c''$  which corresponds to the previous case. Similarly, if  $v_k$  does not belong to  $C$ , we can swap the component of  $K(c', c'')$  containing  $v_k$  to obtain a coloring where  $(vv_1, \dots, vv_k)$  is a fan around  $v$  starting at  $vv_1$  where  $c''$  is missing at both  $v$  and  $v_k$ , this coloring also corresponds to the previous case, hence we are done.

□

#### 1.4.4 Reconfiguration questions: Kempe equivalence

Kempe chains were invented as a technical tool to bound the number of colors needed in a proper coloring? Their original purpose was to build an optimal solution to the problem of  $k$ -coloring. However, given a proper  $k$ -coloring  $\varphi$ , applying a Kempe swap on  $\varphi$  also gives a proper coloring  $\varphi'$ , so one can ask the following question: what are the colorings that can be obtained from  $\varphi$  using only Kempe swaps. This question falls in the more general field of combinatorial reconfiguration. Given a set of solution  $S$ , here the set of  $k$ -colorings, and a *reconfiguration step*, here the Kempe swaps, is it always possible to transform a solution  $s_1$  into a solution  $s_2$  using only the reconfiguration step such that all the intermediate steps are also in the set  $S$ ? In the case of coloring, we say that two  $k$ -colorings are *Kempe equivalent* (or simply equivalent) if one can find a sequence of Kempe swaps to transform the first coloring into the second coloring. By definition of a Kempe swap, all the intermediate colorings are guaranteed to be also proper.

Equivalently, we can define the *reconfiguration graph*  $\mathcal{G}_k(G)$  whose vertex set is the set of  $k$ -colorings of  $G$ , and where two colorings are adjacent if one can transform the first one into the other with a unique Kempe swap. The colorings  $\varphi_1$  and  $\varphi_2$  are hence equivalent if their corresponding vertices lie in the same *connected component* of  $\mathcal{G}_k(G)$ . Much work on these graphs has actually focused on a stricter version of the reconfiguration step: *trivial Kempe swaps*. A Kempe swap is trivial if it only consists in changing the color of a single vertex (or a single edge in the case of edge-coloring). In this context, two questions are mainly studied: given two colorings, what is the complexity of deciding whether or not they lie in the same component of  $\mathcal{G}_k(G)$ ? And if it is the case, what is the *diameter* of this component (the diameter of the component thus corresponds to the length of a maximum reconfiguration sequence); see [BB18], [BJL<sup>+</sup>14], [BC09], and [BMNR14] for instance.

In the case of non-trivial Kempe swaps, the same type of question were studied (see e.g. [Moh06] for a comprehensive overview or [BBFJ19] for a recent result on general graphs). Fisk [Fis77] showed that all the 4-colorings of Eulerian triangulations are equivalent (an Eulerian triangulation is 3-colorable, so only one more color than the optimal is sufficient for all the colorings to be equivalent). Meyniel generalized this result to 4-chromatic planar graphs by showing that all the 5-colorings of a planar graph are equivalent and Mohar settled the case of planar graphs [Moh06] by showing that all  $k$ -colorings of a planar graph  $G$  are Kempe equivalent when  $k > \chi(G)$ . In Section 1.2.2 we have seen that planar graphs can be characterized as graphs with no  $K_5$  and no  $K_{3,3}$  as minor;

the result of Meyniel was generalized to  $K_5$ -minor graphs by Meyniel and Las Vergnas, they showed that all 5-colorings of a  $K_5$ -minor free graphs are Kempe equivalent.

Meyniel and Las Vergnas also conjectured a “reconfiguration version” of the Hadwiger Conjecture.

**Conjecture 1.4.3.** *For all  $k$ , all the  $k$ -colorings of a  $K_k$ -minor free graph are Kempe equivalent.*

If Hadwiger’s conjecture, and this conjecture was true, it would mean that any coloring of a graph  $G$  can be transformed, via Kempe swaps, into any other coloring with just one additional spare color used for the swaps. Hadwiger conjecture is still widely open, and in this thesis, we disprove the second conjecture (see Section 3.1).

In [Mey78], Meyniel also show (implicitly) the following Lemma on  $k$ -degenerate graphs which is of its own interest.

**Lemma 1.4.4.** *If a graph  $G$  is  $k$ -degenerate, then all its  $(k+1)$ -colorings are equivalent.*

Many results on Kempe equivalence that we will present in the next section heavily rely on this seminal lemma. Showing that a reconfiguration graph is connected consists in building a reconfiguration sequence. However, to show that a reconfiguration graph is not connected, the only known method relies on the concept of *frozen coloring*. A coloring is frozen if for any pair of colors  $a, b$ , the induced subgraph  $K(a, b)$  has a unique component. This means that all the vertices colored  $a$  or  $b$  in the graph are in the same Kempe chain, and thus, swapping this chain only consists in renaming the colors and does not change the vertex partition corresponding to the coloring. A *frozen  $k$ -coloring*  $\varphi$  of a graph  $G$  and the equivalent colorings form a connected component of the reconfiguration graph  $\mathcal{G}_k(G)$ , and thus, if one can find a coloring different from  $\varphi$  (in the sense that the vertex partition is different), then we are guaranteed to have at least two components in  $\mathcal{G}_k(G)$ .

Regarding (non-trivial) *Kempe equivalence* of vertex colorings, Feghali, Jonhson and Paulusma showed that 4-colorings of cubic graphs are equivalent unless the graph is a triangular prism (recall that by Brooks theorem (Theorem 1.3.4), a  $k$ -regular graph is  $k$ -colorable unless it is a clique), see Figure 1.20 for the two non-equivalent coloring of the prism. Bonamy, Bousquet, Feghali and Jonhson [BBFJ19] generalized this result to  $k$ -regular graphs.

**Theorem 1.4.5** ([BBFJ19]). *Let  $G$  be a connected  $k$ -regular graph. If  $G$  is not the triangular prism, all the  $k$ -colorings of  $G$  are Kempe equivalent.*



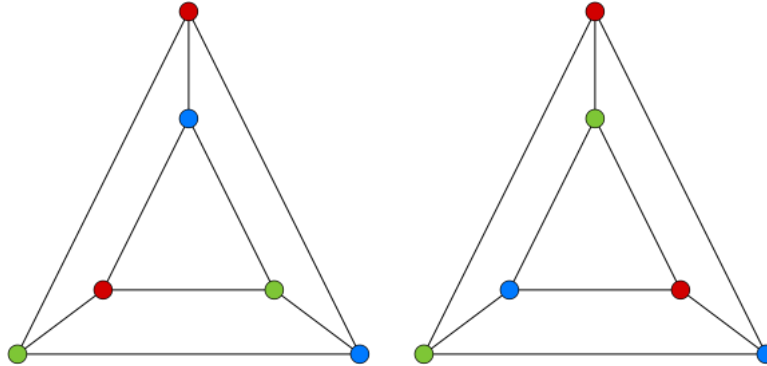

Figure 1.20: Two non equivalent coloring of the triangular prism, each of these colorings is frozen.

The length of the reconfiguration sequence has also received a particular attention. For instance Bonamy, Delecroix and Legrand-Duchesne [BDLD21] proved that the **diameter** of the reconfiguration graph of the  $\Delta(G)$ -colorings of a graph  $G$  is a polynomial in the number of vertices  $G$ .

**Theorem 1.4.6** ([BDLD21]). *Let  $G$  be a connected graph, then  $\mathcal{G}_{\Delta(G)}(G)$  has diameter at most  $\mathcal{O}(n^2)$  unless  $G$  is the triangular prism.*

The problem of coloring reconfiguration can also be generalized to **list-coloring**: a  $(a, b)$ -**Kempe swap** is only possible if all the vertices of the considered Kempe chain have the colors  $a$  and  $b$  in their respective lists. Cranston and Mahmoud [CM21] recently proved that, except a few exceptions, given a graph  $G$  and a list assignment  $L$  of the vertices of  $G$  where all lists have size at least  $\Delta(G)$ , then all the  $L$ -colorings are equivalent.

**Theorem 1.4.7** ([CM21]). *Let  $G$  be a connected graph of maximum degree at least 3, which is not a complete graph nor the triangular prism, and  $L$  a list-assignment of the vertices where each list has size at least  $\Delta(G)$ , all the  $L$ -colorings are equivalent.*

Whilst irrelevant for this thesis, it should be noted that coloring reconfiguration and coloring sampling are closely related (see e.g. [Sok00, MS09] for nice overviews). Sampling a coloring consists in picking a coloring uniformly at random from the set of all possible colorings. Due to combinatorial explosion, it is usually unfeasible to generate all the possible colorings. Hence to build a coloring that “resembles” a coloring picked at random, an efficient way consists in starting from an arbitrary coloring and reconfiguring it randomly for a sufficient amount of time (see [Vig00] for instance). Results on graph coloring reconfiguration are hence also used in statistical physic.

A set of particles that can have different states can be modeled by colored vertices of a graph: each color correspond to a specific state of a particle. In some specific context, the state of a particle cannot be the identical to the states of its closest neighbors, and thus when a particle has its state changed, it propagates the change to its neighboring particles such that no particle with the exact same state are too close from each other. It is thus natural to model these problems as Kempe swaps on vertex-coloring. The Wang–Swendsen–Kotecký (WSK) relies on this principle (see [WSK89] and [WSK90] for more about the antiferromagnetic Potts model and the WSK algorithm), and for instance Mohar [MS10] proved that some instances of graphs modeling statistical mechanic problems have disconnected reconfiguration graphs, which implies that not all colorings can be obtained by taking a random walk on the reconfiguration graph.

# Chapter 2

## Vizing's edge-coloring conjecture

In this chapter, we present our work on Vizing's edge-coloring conjecture. We first present joint work with Marthe Bonamy, Oscar Defrain, Tereza Klimošová, and Aurellie Lagoutte on the triangle-free case [BDK<sup>+</sup>21]. This work has been submitted to the Journal of Combinatorial Theory Series B, and is still under revision. The authors of this work would like to thank Caroline Brosse, Vincent Limouzy, Carole Muller and Lucas Pastor for extensive discussions around this topic. We then present a personal work on the general case where we prove the conjecture, this work is still in preparation and has not been submitted yet.

### 2.1 Introduction

As discussed in Section 1.3.3, Vizing proved in 1964 [Viz64] that to properly color the edges of a simple graph, it suffices to have one more color than the maximum number of neighbors.

**Theorem 2.1.1** ([Viz64]). *Any simple graph  $G$  satisfies  $\chi'(G) \leq \Delta(G) + 1$ .*

As mentioned in Section 1.4.3, Vizing actually proves a result on edge-coloring reconfiguration.

**Theorem 2.1.2** ([Viz64]). *For every simple graph  $G$ , for any integer  $k > \Delta(G) + 1$ , for any  $k$ -edge-coloring  $\alpha$ , there is a  $(\Delta(G) + 1)$ -edge-coloring that can be reached from  $\alpha$  through a series of Kempe changes.*

In the follow-up paper extending the result to multigraphs [Viz65a], and later in a more publicly available survey paper [Viz68], Vizing asks whether an optimal coloring can always be reached through a series of Kempe changes, as follows.

*Question 2.1.3* ([Viz65a]). For every simple graph  $G$ , for any integer  $k > \chi'(G)$ , for any  $k$ -edge-coloring  $\alpha$ , is there a  $\chi'(G)$ -edge-coloring that can be reached from  $\alpha$  through a series of Kempe changes?

Question 2.1.3 is in fact stated in the more general context of multigraphs.

Note that neither Theorem 2.1.2 nor Question 2.1.3 implies that all colorings with fewer colors are reachable, i.e., there is no choice regarding the target coloring. We say two  $k$ -edge-colorings are *Kempe-equivalent* if one can be reached from the other through a series of Kempe changes using colors from  $\{1, \dots, k\}$ . Question 2.1.3, if true, would imply [AC16] and the following conjecture of Mohar [Moh06], using the target  $\chi'(G)$ -coloring as an intermediate coloring.

**Conjecture 2.1.4** ([Moh06]). *For every simple graph  $G$ , all  $(\Delta(G) + 2)$ -edge-colorings are Kempe-equivalent.*

Mohar proved the weaker case where  $(\chi'(G) + 2)$  colors are allowed.

**Theorem 2.1.5** ([Moh06]). *For every simple graph  $G$ , all  $(\chi'(G) + 2)$ -edge-colorings are Kempe-equivalent.*

As noted in [MMS12], Theorem 2.1.5 is not true when replacing  $(\chi'(G) + 2)$  with  $\chi'(G)$ , regardless of whether  $\chi'(G) = \Delta(G)$  (consider the graph  $K_{5,5}$ ) or  $\chi'(G) = \Delta(G) + 1$  (consider the graph  $K_5$ ). As noted in [Moh06], it could however be true with  $(\chi'(G) + 1)$ .

Not much is known towards Question 2.1.3 or Conjecture 2.1.4. In 2012, McDonald, Mohar and Scheide [MMS12] proved the case  $\Delta(G) = 3$  of the former (hence the case  $\Delta(G) = 4$  of the latter). In 2016, Asratian and Casselgren [AC16] proved the case  $\Delta(G) = 4$  of the former (hence the case  $\Delta(G) = 5$  of the latter). We answered both questions affirmatively, regardless of the value of  $\Delta(G)$ .

**Theorem 2.1.6.** *For every graph  $G$ , for any integer  $k > \chi'(G)$ , any given  $\chi'(G)$ -edge-coloring can be reached from any  $k$ -edge-coloring through a series of Kempe changes.*

The following corollary is a direct consequence of this theorem.

**Corollary 2.1.7.** *For every graph  $G$ , all  $(\chi'(G) + 1)$ -edge-colorings are Kempe equivalent.*

While the above is sole author, the case of triangle-free graphs were handled in a joint work with Marthe Bonamy, Oscar Defrain, Tereza Klímová and Aurellie Lagoutte [BDK<sup>+</sup>21].

The general approach toward Theorem 2.1.6 follows that of [AC16], which itself follows that of [Moh06]. From a  $k$ -edge-coloring with  $k > \chi'(G)$ , say

we aim to reach a given  $\chi'(G)$ -coloring  $\alpha$ . We select a color class  $M$  of  $\alpha$ , and seek through a series of Kempe changes to reach a  $k$ -edge-coloring where  $M$  is monochromatic and its color appears on no other edge. We can then delete  $M$  and apply induction on  $\chi'(G)$ .

## Complexity implications

As is often mentioned, Vizing's original argument can be turned into a polynomial-time algorithm—this was formally noted by Misra and Gries [MG92]. However, deciding whether a graph  $G$  is  $\Delta(G)$ -edge-colorable is an NP-complete problem [Hol81], even in the case of triangle-free graphs [Kor97]. This leaves little hope for extracting a polynomial-time algorithm from the proof of Theorem 2.1.6. There is however no difficulty in detecting the difference between Vizing's argument and ours: we start by assuming full access to a  $\Delta(G)$ -edge-coloring, which is crucial in the proof.

### 2.1.1 General setting of the proof

Let us argue that it suffices to handle the case of a  $\chi'(G)$ -regular graph. Indeed, any graph  $G$  is the induced subgraph of a  $\chi'(G)$ -regular graph that is also  $\chi'(G)$ -edge-colorable. To see this, we decrease step-by-step the difference between  $\chi'(G)$  and the smallest degree of a vertex in  $G$ . Let  $\beta$  be a  $\chi'(G)$ -edge-coloring of  $G$ , and consider two copies of  $G$ , each colored  $\beta$ . We add an edge between both copies of every vertex of smallest degree: since both copies of  $G$  are colored the same, there is a color available for the new edge. Note that this construction does not create any triangle. See Figure 2.1 for an example.

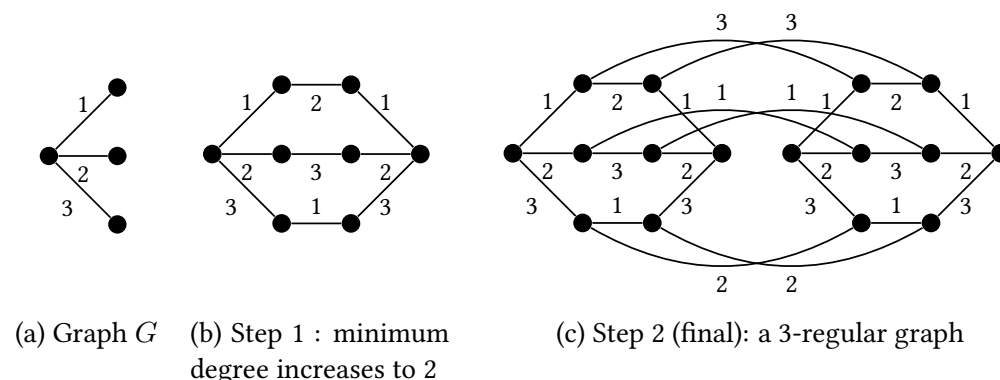

Figure 2.1: Construction of a 3-regular 3-edge colourable graph from a 3-edge colourable graph

Additionally, note that any series of Kempe changes in a graph has a natural transposition to any induced subgraph of it. Indeed, if a Kempe chain in the graph corresponds to more than one Kempe chain in the induced subgraph, it suffices to operate the swap in every such Kempe chain.

This allows us to restrict our attention to the case where  $\Delta(G) = \chi'(G)$  and the color class  $M$  is a perfect matching, which will prove to be convenient. Theorem 2.1.6 was already proved in [Moh06] when  $k \geq \chi'(G) + 2$ . Therefore, we focus on the case  $k = \chi'(G) + 1$ , though the reader can convince themselves that the proof could be adapted for higher  $k$  with a loss in simplicity.

From now on, we consider only  $(\Delta(G) + 1)$ -edge-colorings of a  $\Delta(G)$ -regular graph  $G$ . Therefore, for every such coloring  $\alpha$ , and for every vertex  $u$ , there is a unique color  $m_\alpha(u)$  in  $\{1, \dots, \Delta + 1\} \setminus \{\alpha(uv) \mid v \in N(u)\}$ , referred to as the *missing color* of  $\alpha$  at  $u$ .

We defined the notion of Kempe changes in the introduction: let us introduce some helpful notation around them. For any coloring  $\alpha$ , for any two (distinct) colors  $c, d$ , we denote by  $K^\alpha(c, d)$  the subgraph of  $G$  induced by the edges colored  $c$  or  $d$ . The notion of a component of  $K^\alpha(c, d)$  containing an edge  $e$  is straightforward. We extend this notion to that of a component containing a vertex  $u$ . To describe a Kempe change, we will indicate that we swap the component of  $K^\alpha(c, d)$  containing this edge or that vertex, for some given  $c$  and  $d$ . We will write  $\alpha \rightsquigarrow \beta$  to indicate that two  $k$ -edge-colorings  $\alpha$  and  $\beta$  are Kempe-equivalent. Formally, we should indicate the bound on the number of colors involved in an intermediary coloring in the sequence of Kempe changes. However, we believe that there is no ambiguity anywhere regarding this. In particular, throughout the proof we only involve colors in  $\{1, \dots, \Delta(G) + 1\}$ .

### 2.1.2 Fan-like tools

Let  $\alpha$  be a  $(\Delta + 1)$ -edge-coloring of a  $\Delta$ -regular graph  $G$ . Consider an edge  $uv$ , and say we want to recolor it. If  $m(u) = m(v)$ , this can be done immediately without impacting the rest of the coloring. Therefore, let us consider  $m(v) \neq m(u)$ , and look at the obstacles around  $u$ . There is an edge  $uw$  colored  $m(v)$ . Again, if we can recolor it without impacting the rest of the coloring, we can then recolor  $uv$  into  $m(v)$ . This prompts us to define a directed graph  $D_u(\alpha)$  on vertex set  $\{uw \mid w \in N(u)\}$ , where a vertex  $uw$  has a directed edge to  $ux$  if  $m(w) = \alpha(ux)$  (see Figure 2.2). Note that by definition, every vertex in  $D_u(\alpha)$  has out-degree 0 or 1, and arbitrarily large in-degree. Consider the sequence  $X_u(\alpha, v)$  of vertices that can be reached from  $uv$  in  $D_u(\alpha)$ . For both  $D_u(\alpha)$  and  $X_u(\alpha, v)$ , we drop  $\alpha$  from the notation when it is clear from context.

We have three possible scenarios, by increasing difficulty (see Figure 2.2 for an illustration):

## 2. Vizing's edge-coloring conjecture

1.  $X_u(v)$  induces a path in  $D_u$ .
2.  $X_u(v)$  induces a cycle in  $D_u$ .
3.  $X_u(v)$  induces a comet in  $D_u$ , where a *comet* is obtained from a directed path by adding an edge from the sink to a vertex that is neither the source nor the sink.

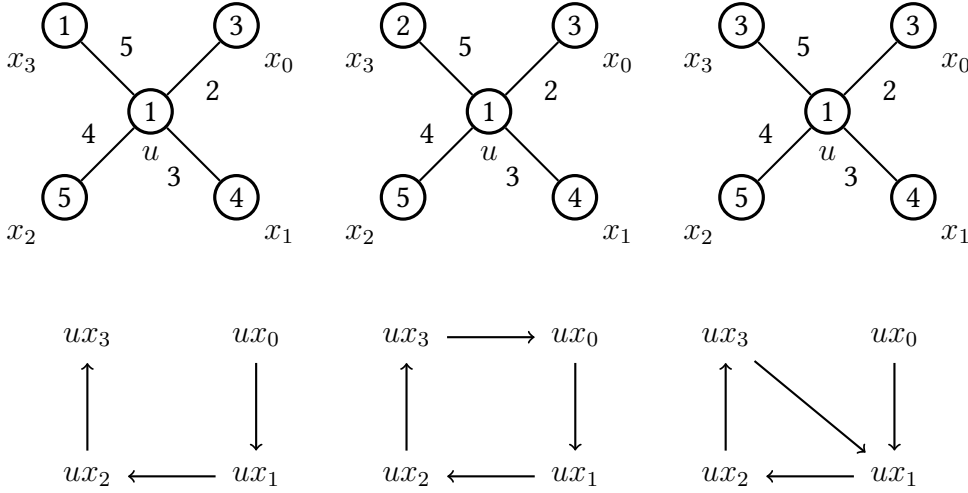

Figure 2.2: From left to right, the three possible scenarios for a sequence  $X_u(\alpha, x_0)$  in the digraph  $D_u(\alpha)$ : a path, a cycle or a comet. (Vertices are labeled by the missing colors.)

For any edge  $uv$ , if  $X_u(\alpha, v)$  induces a path or cycle in  $D_u$ , we denote by  $X_u^{-1}(\alpha, v)$  the coloring obtained from  $\alpha$  by assigning the color  $m(u)$  to every edge  $uw \in X_u(\alpha, v)$ . Note that for every edge  $uw \in X_u(\alpha, v)$ , we have  $m_{X_u^{-1}(\alpha, v)}(w) = \alpha(uw)$ . We refer to this operation on  $\alpha$  as *inverting*  $X_u(\alpha, v)$ . Figure 2.3 illustrates the result of inverting a path. We drop  $v$  from the notation when there is no ambiguity.

In order to have an overview of the key ingredients in the proof, let us now state an Observation and some Lemmas, the proof of which are postponed to the following subsections.

**Observation 2.1.8.** For any vertex  $u$  and path  $X_u(\alpha)$  in  $D_u(\alpha)$ ,  $\alpha \rightsquigarrow X_u^{-1}(\alpha)$ .

**Definition 2.1.9.** For any vertex  $u$  and cycle  $X_u(\alpha) = (ux_0, \dots, ux_p)$  in  $D_u(\alpha)$ , we say that  $X_u(\alpha)$  is saturated if for every  $0 \leq i \leq p$ , the component of  $K(\alpha(ux_i), m(u))$  containing  $u$  also contains  $x_{i-1}$  (resp.  $x_p$  if  $i = 0$ ).

The same conclusion holds for cycles unless the sequence is saturated:

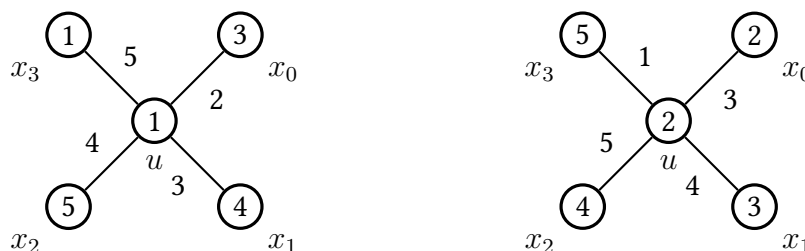

Figure 2.3: Coloring  $\alpha$  (left) and  $X_u^{-1}(\alpha, x_0)$  (right) when  $X_u(\alpha, x_0)$  is a path.

**Lemma 2.1.10.** *For any vertex  $u$  and non-saturated cycle  $X_u(\alpha)$  in  $D_u(\alpha)$ ,  $\alpha \rightsquigarrow X_u^{-1}(\alpha)$ .*

For comets, it suffices to allow one Kempe change outside of  $X_u(\alpha)$ :

**Lemma 2.1.11.** *For any vertex  $u$  and comet  $X_u(\alpha) = (ux_0, \dots, ux_p)$  in  $D_u(\alpha)$ , we have  $\alpha \rightsquigarrow \alpha'$ , where  $\alpha'$  satisfies  $m_{\alpha'}(u) = \alpha(ux_0)$  and is obtained from  $\alpha$  by changing the color of some edges in  $X_u(\alpha)$  and possibly swapping one component  $C$  in  $K(m(u), \alpha(ux_q))$ , where  $ux_q$  is the endpoint of the out-edge from  $ux_p$  in  $D_u(\alpha)$ .*

In the coloring  $\alpha'$  obtained from Lemma 2.1.11, we stress the fact that the number of edges colored  $\alpha(ux_0)$  strictly decreases as the swapped component  $C$  does not contain such a color, and  $m_{\alpha'}(u) = \alpha(ux_0)$ , i.e., no edge incident to  $u$  has color  $\alpha(ux_0)$  in  $\alpha'$ .

We prove the lemmas by increasing difficulty in the following subsections.

### 2.1.3 Gentle introduction: a proof of Observation 2.1.8

*Proof of Observation 2.1.8.* Let  $X_u(\alpha) = (ux_0, \dots, ux_p)$  be a path in  $D_u(\alpha)$ . Intuitively, we will start recoloring edges from the end of the path to its beginning. Observe that since  $X_u(\alpha)$  is a path, by construction of  $D_u(\alpha)$  there is no edge incident to  $u$  that has color  $m(x_p)$ , hence  $m(u) = m(x_p)$ . We proceed by induction on  $p$ . When  $p = 0$ , we have  $m(x_0) = m(u)$ , thus swapping the single-edge component of  $K(\alpha(ux_0), m(u))$  containing  $ux_0$  yields the desired coloring  $X_u^{-1}(\alpha)$ .

Similarly, for  $p > 0$ , we swap the (single-edge) component of  $K(\alpha(ux_p), m(u))$  containing  $ux_p$ , and denote by  $\alpha'$  the resulting coloring. We note that in  $D_u(\alpha')$ , the sequence  $X_u(\alpha', x_0)$  is exactly the path  $(ux_0, \dots, ux_{p-1})$ . Moreover,

$X_u(\alpha', x_0) = X_u^{-1}(\alpha)$ . By induction we derive  $\alpha' \rightsquigarrow X_u^{-1}(\alpha)$ , hence  $\alpha \rightsquigarrow X_u^{-1}(\alpha)$ .  $\square$



### 2.1.4 Comets: a proof of Lemma 2.1.11

*Proof of Lemma 2.1.11.* Let  $X_u(\alpha) = (ux_0, \dots, ux_p)$  be a comet in  $D_u(\alpha)$ , with  $x_q$  the endpoint of the out-edge from  $ux_p$  in  $D_u(\alpha)$ . Since  $X_u(\alpha)$  is a comet,  $0 < q < p$ . We swap the component  $C$  of  $K(m(u), \alpha(ux_q))$  containing the edge  $ux_q$ , and denote by  $\alpha'$  the resulting coloring. In  $\alpha$ , we have  $m_\alpha(x_p) = m_\alpha(x_{q-1}) = \alpha(ux_q)$ . Since  $C$  must be a path, it contains at most two vertices (its endpoints) whose missing color in  $\alpha$  belongs to  $\{m(u), \alpha(ux_q)\}$ . We know that  $C$  already contains  $u$ , so at least one of  $x_p$  and  $x_{q-1}$  has the same missing color in  $\alpha$  and  $\alpha'$ . We distinguish the two cases.

- Assume  $m_{\alpha'}(x_{q-1}) = \alpha(ux_q)$ . Since  $m_{\alpha'}(u) = \alpha(ux_q)$ , it follows that in  $D_u(\alpha')$ , the sequence  $X_u(\alpha', x_0)$  is exactly  $(ux_0, \dots, ux_{q-1})$ , which induces a path. We then conclude by Observation 2.1.8.
- If not,  $m_{\alpha'}(x_{q-1}) = \alpha'(ux_q)$ , and  $m_{\alpha'}(x_p) = \alpha(ux_q)$ . Since  $m_{\alpha'}(u) = \alpha(ux_q)$ , it follows that in  $D_u(\alpha')$ , the sequence  $X_u(\alpha', x_0)$  is exactly  $(ux_0, \dots, ux_p)$ , which induces a path. We then conclude by Observation 2.1.8.

□

### 2.1.5 Non-saturated cycles: a proof of Lemma 2.1.10

*Proof of Lemma 2.1.10.* Let  $X_u(\alpha) = (ux_0, \dots, ux_p)$  be a non-saturated cycle in  $D_u(\alpha)$ . Without loss of generality since  $X_u(\alpha)$  induces a cycle that is not saturated, we can assume that the component of  $K(\alpha(ux_0), m(u))$  containing  $u$  does not contain an edge incident with  $x_p$ . By definition of  $D_u(\alpha)$ , we have  $m(x_i) = \alpha(ux_{i+1})$  for every  $0 \leq i < p$ , and as illustrated on Figure 2.4(a)  $m(x_p) = \alpha(ux_0)$ . We consider the coloring  $\alpha'$  obtained from  $\alpha$  by swapping the component  $C$  of  $K(\alpha(ux_0), m(u))$  containing  $x_p$  ( $C$  is referred to as a 1-2 chain on Figure 2.4(a), see Figure 2.4(b) for the resulting coloring). By assumption, this has no impact on the colors of the edges incident with  $u$ , and  $m_\alpha(x_i) = m_{\alpha'}(x_i)$  for every  $0 \leq i < p$ , as well as  $m_\alpha(u) = m_{\alpha'}(u)$ . Note however that  $m_{\alpha'}(x_p) = m_\alpha(u)$ . In the coloring  $\alpha'$ ,  $X_u(\alpha', x_0) = (ux_0, \dots, ux_p)$  is a path, thus by Observation 2.1.8,  $\alpha' \rightsquigarrow X_u^{-1}(\alpha', x_0)$ ; we denote this resulting coloring by  $\alpha''$  (see Figure 2.4(c)). In the coloring  $\alpha''$ , let  $C'$  be the component of  $K(\alpha(ux_0), m_\alpha(u))$  containing  $x_p$ . We have that  $C' = C \cup \{ux_p\}$ , and that  $m_{\alpha''}(u) = \alpha(ux_0)$ , so it suffices to swap  $C'$  to obtain  $X_u^{-1}(\alpha)$  as illustrated on Figure 2.4(d). Hence  $\alpha \rightsquigarrow \alpha' \rightsquigarrow X_u^{-1}(\alpha', x_0) \rightsquigarrow X_u^{-1}(\alpha)$ , as desired. □

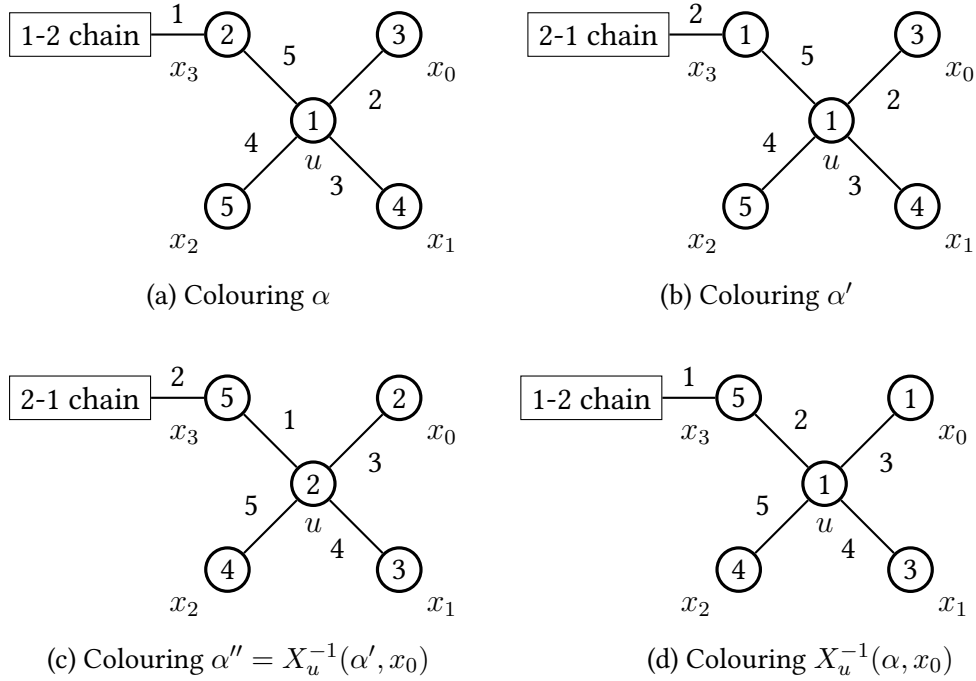

Figure 2.4: Colorings  $\alpha \rightsquigarrow \alpha' \rightsquigarrow X_u^{-1}(\alpha', x_0) \rightsquigarrow X_u^{-1}(\alpha, x_0)$ .

## 2.2 Vizing's edge-coloring conjecture for triangle-free graphs

In this section, we prove that the conjecture holds for triangle-free graphs. Namely, we prove the following theorem:

**Theorem 2.2.1.** *For every triangle-free graph  $G$ , for any integer  $k > \chi'(G)$ , any given  $\chi'(G)$ -edge-coloring can be reached from any  $k$ -edge-coloring through a series of Kempe changes.*

Theorem 2.2.1 improves upon an earlier theorem concerning bipartite graphs [Asr09]. We prove it in Section 2.2.2, but before that we need some further result on saturated cycles.

### 2.2.1 Double cycles

As mentioned above, to prove Theorem 2.2.1, we need to handle the case of saturated cycles. We show that if the graph is triangle-free, a saturated cycle adjacent to another cycle is invertible.

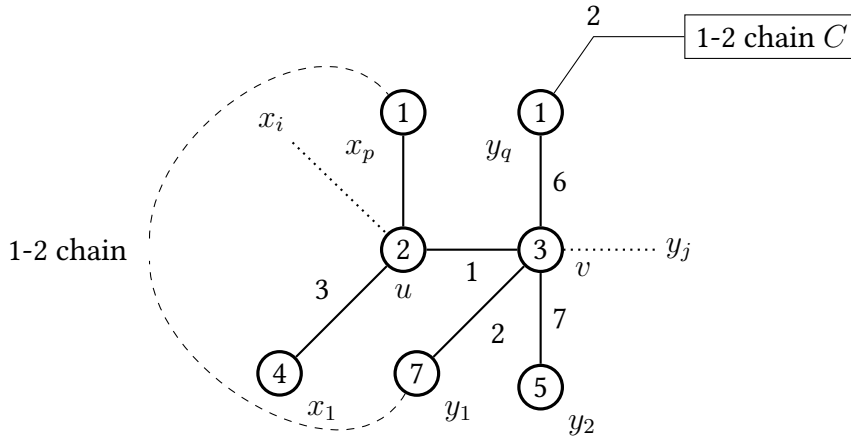

Figure 2.5: Double cycles: Illustration of the beginning of the proof of Lemma 2.2.2: In colouring  $\alpha$ , the vertex  $y_q$  is in a different component of  $K(\alpha(uv), m(u))$  than  $u$  and  $x_p$ .

**Lemma 2.2.2.** *For any vertex  $u$  and saturated cycle  $X_u(\alpha, v)$  in  $D_u(\alpha)$ , if  $G$  is triangle-free, and if the sequence  $Y_v(\alpha, u)$  of vertices of  $D_v(\alpha)$  induces a cycle, then  $\alpha \rightsquigarrow X_u^{-1}(\alpha, v)$ .*

*Proof.* Let  $X_u = (uv, ux_1, \dots, ux_p)$  be a saturated cycle in  $D_u(\alpha)$ , and  $Y_v = (vu, vy_1, \dots, vy_q)$  be a cycle in  $D_v(\alpha)$ . Observe that  $m(v) \neq m(u)$ , otherwise  $X_u$  and  $Y_v$  contain only the edge  $uv$  and thus do not induce cycles. Note that  $m(x_p) = m(y_q) = \alpha(uv)$  and by triangle-freeness  $x_p \neq y_q$ .

Figure 2.5 illustrates the following argument. Since  $X_u$  is saturated, the component of  $K(\alpha(uv), m(u))$  containing  $u$  also contains  $x_p$ , and thus does not contain  $y_q$ . In particular, it follows that  $q \geq 2$ , since by definition  $\alpha(vy_1) = m(u)$  and thus  $y_1$  is in the same component of  $K(\alpha(uv), m(u))$  as  $u$  and  $x_p$ , while  $m(y_q) = \alpha(uv)$ .

Let  $C$  be the component of  $K(\alpha(uv), m(u))$  containing  $y_q$ . We note that  $C$  and  $X_u \cup Y_v$  are disjoint, and that neither endpoint of  $C$  is incident to an edge of  $X_u \cup Y_v \setminus \{vy_q\}$ , as the only vertices missing colors  $\alpha(uv)$  or  $m_\alpha(u)$  in  $X_u \cup Y_v$  are by definition  $u$ ,  $x_p$ , and  $y_p$ , since  $X_u$  and  $Y_v$  induce cycles. We consider the coloring  $\alpha_1$  obtained from  $\alpha$  by swapping  $C$  (see Figure 2.6 for all the intermediate colorings used in this proof). For every  $x_i$ , we have  $\alpha(ux_i) = \alpha_1(ux_i)$  and  $m_\alpha(x_i) = m_{\alpha_1}(x_i)$ ; similarly for  $u, v$ , and every  $y_j$  with  $1 \leq j < q$ .

The sequence  $X_u$  is also a cycle-inducing sequence of vertices that can be reached from  $uv$  in  $D_u(\alpha_1)$ . However,  $X_u$  may not be saturated in  $\alpha_1$ . We distinguish the two cases.

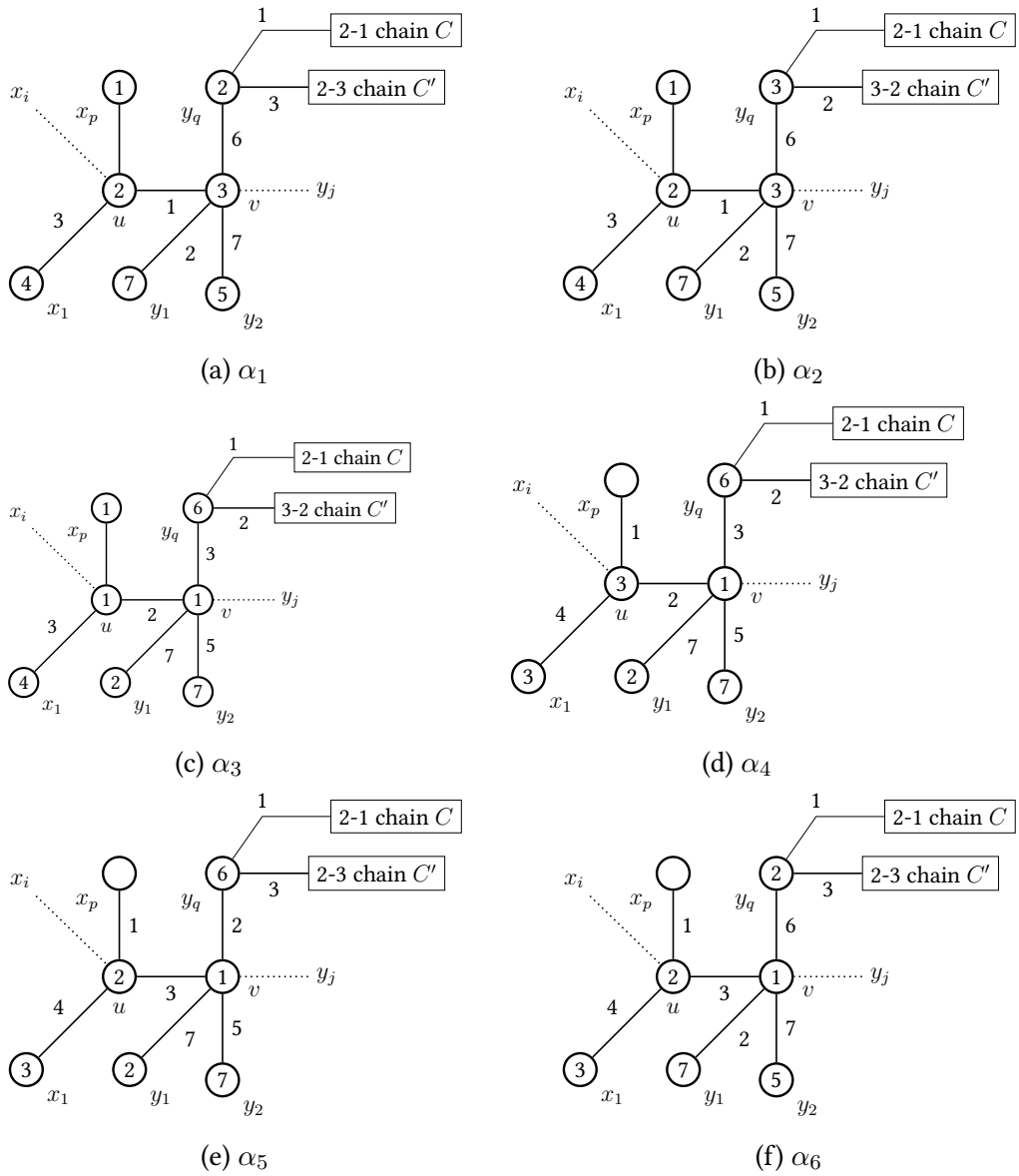

Figure 2.6: Double cycles : illustration of the intermediate colouring in the proof of Lemma 2.2.2.

- Assume that  $X_u$  is not saturated in  $\alpha_1$ . By Lemma 2.1.10, we have  $\alpha_1 \rightsquigarrow X_u^{-1}(\alpha_1)$ . By swapping  $C$  for the second time (remember that  $C$  and  $X_u$  are disjoint, and that neither endpoint of  $C$  is incident to an edge of  $X_u$ ), we obtain  $X_u^{-1}(\alpha)$ , hence the conclusion.
- Assume now that  $X_u$  is saturated in  $\alpha_1$ . Hence the component of  $K(m_{\alpha_1}(u), m_{\alpha_1}(v))$  containing  $u$  also contains  $v$  thus does not contain  $y_q$ , since  $m_{\alpha_1}(y_q) = m_{\alpha_1}(u)$ .

Let  $C'$  be the component of  $K(m_{\alpha_1}(u), m_{\alpha_1}(v))$  containing  $y_q$ . Similarly as for  $C$ , we note that  $C'$  and  $X_u \cup Y_v$  are disjoint, and that neither endpoint of  $C'$  is incident to an edge of  $X_u \cup Y_v \setminus \{vy_q\}$ . We consider the coloring  $\alpha_2$  obtained from  $\alpha_1$  by swapping  $C'$ . In  $D_v(\alpha_2)$ , the sequence  $(vu, vy_1, \dots, vy_q)$  is the sequence of vertices of  $D_v(\alpha_2)$  that can be reached from  $uv$ , and it induces a path. Let  $\alpha_3 = (uv, vy_1, \dots, vy_q)^{-1}(\alpha_2)$ . By Observation 2.1.8, we have  $\alpha_2 \rightsquigarrow \alpha_3$ . Note that  $\alpha_3$  assigns the color  $\alpha(uv)$  to no edge in  $X_u \cup Y_v$ . In  $D_u(\alpha_3)$ , the sequence  $(ux_1, \dots, ux_p)$  is the sequence of vertices that can be reached from  $ux_1$ , and it induces a path. Let  $\alpha_4$  be the coloring  $(ux_1, \dots, ux_p)^{-1}(\alpha_3)$ . By Observation 2.1.8, we have  $\alpha_3 \rightsquigarrow \alpha_4$ . Note that in  $\alpha_4$ , we have  $m_{\alpha_4}(v) = \alpha(uv)$  and  $m_{\alpha_4}(u) = m_\alpha(v)$ , with  $\alpha_4(uv) = m_\alpha(u)$ . Note that there is a unique connected component of  $K(m_\alpha(u), m_\alpha(v))$  containing vertices of  $C'$ , which is precisely  $C' \cup \{uv, vy_q\}$ .

In the coloring  $\alpha_5$  obtained from  $\alpha_4$  by swapping  $C' \cup \{uv, vy_q\}$ , there is a unique component of  $K(\alpha(uv), m_\alpha(u))$  containing vertices of  $C$ , which is precisely  $C \cup \{vy_q\}$ . Moreover, in the coloring  $\alpha_5$ , the sequence  $(vy_1, vy_q, vy_{q-1}, \dots, vy_2)$  induces a cycle in  $D_v$ . The cycle is not saturated since the component of  $K(\alpha(uv), m_\alpha(u))$  containing vertices of  $C$  is precisely  $C \cup \{vy_q\}$ : since  $q \geq 2$ , it does not contain  $y_1$ . We consider the coloring  $\alpha_6$  obtained from  $\alpha_5$  by inverting  $(vy_1, vy_q, vy_{q-1}, \dots, vy_2)$ . By Lemma 2.1.10, we obtain  $\alpha_5 \rightsquigarrow \alpha_6$ . Note that in  $\alpha_6$ , the component of  $K(\alpha(uv), m_\alpha(u))$  containing vertices of  $C$  is precisely  $C$ : we swap it and obtain  $\alpha \rightsquigarrow X_u^{-1}(\alpha)$ , as desired.

□

We are now ready to prove the main result of this section.

### 2.2.2 The good, the bad and the ugly (edges)

In this section, we prove Theorem 2.2.1. We essentially follow the outline of [AC16], and proceed by induction on  $\Delta$ . Given a  $\Delta$ -regular triangle-free graph

$G$  that is  $\Delta$ -edge-colorable, we consider a  $(\Delta + 1)$ -edge-coloring  $\alpha$  and a target  $\Delta$ -edge coloring  $\gamma$ . Let  $M$  be a color class of  $\gamma$ , and note that  $M$  is a perfect matching. We fix a color out of  $\{1, 2, \dots, \Delta + 1\}$ , say 1, and try, through Kempe changes from  $\alpha$ , to assign the color 1 to every edge in  $M$ . If we succeed, we can delete  $M$  and proceed by induction on  $G \setminus M$  with colors  $\{2, \dots, \Delta + 1\}$ , noting that  $\gamma$  restricted to  $G \setminus M$  uses only  $(\Delta(G) - 1)$  colors. Let us introduce some terminology to quantify how close we are to this goal of assigning the color 1 to every edge in  $M$ .

In a given coloring, we say an edge is:

- *good* if it belongs to  $M$  and is colored 1.
- *bad* if it belongs to  $M$  but is not colored 1.
- *ugly* if it does not belong to  $M$  but is colored 1.

Throughout the proof, we consider exclusively  $(\Delta + 1)$ -colorings that can be reached from  $\alpha$  through a series of Kempe changes: let us denote by  $\mathcal{C}$  all such colorings. We define an order on  $\mathcal{C}$  and we will prove that, in any minimal coloring, all edges of the perfect matching  $M$  are colored 1.

**Definition 2.2.3.** *A coloring in  $\mathcal{C}$  is minimal if it has the fewest bad edges among all colorings in  $\mathcal{C}$ , and among those with the fewest bad edges, has the fewest ugly edges.*

Note that there may be many minimal colorings. If  $m(u) = 1$ , we say the vertex  $u$  is *free*.

**Lemma 2.2.4.** *In a minimal coloring, every ugly edge  $vw$  is such that the sequence of vertices of  $D_v$  reached from  $vw$  induces a cycle.*

*Proof.* We consider a minimal coloring  $\beta$ , and denote by  $X_v(w) = (vw, vx_1, \dots, vx_p)$  the sequence of vertices of  $D_v(\beta)$  reached from  $vw$ . Suppose by contradiction that  $X_v(w)$  does not induce a cycle. The simple yet key observation is that for every  $i$ ,  $m(x_i) \neq 1$ .

If  $X_v(w)$  induces a path, we conclude immediately using Observation 2.1.8, as  $X_v^{-1}(\beta, w)$  has the same number of bad edge as  $\beta$ , and one fewer ugly edge.

Therefore, it suffices to consider the case where  $X_v(w)$  induces a comet. We let  $q$  be such that  $vx_p$  has an out-edge to  $vx_q$  in  $D_v$ . In addition to  $m(x_i) \neq 1$  for every  $1 \leq i \leq p$ , note that  $m(v) \neq 1$ , as  $\beta(vw) = 1$ . The coloring  $\beta'$  obtained from Lemma 2.1.11 has therefore the same number of bad edges as  $\beta$ , and fewer ugly edges. Since  $\beta' \rightsquigarrow \beta$ , this contradicts the minimality of  $\beta$ .  $\square$

By considering the last element of a sequence reached from an ugly edge, Lemma 2.2.4 yields the following statement, whose proof appeared in [AC16] but which we state somewhat differently.

**Corollary 2.2.5** ([AC16]). *In a minimal coloring, both endpoints of an ugly edge have a free neighbor.*

As we shall see, a consequence of Corollary 2.2.5 together with the regularity assumption is that, in a minimal coloring, there are bad edges with a free endpoint (unless there is no bad edge at all). These are central to the argument<sup>1</sup>. Let us now prove a small observation and then proceed with the core of the proof.

**Observation 2.2.6.** *In any minimal coloring  $\beta$ , every bad edge is incident to an ugly edge.*

*Proof.* Let  $xy$  be a bad edge. If  $m(x) = m(y) = 1$ , we can swap the (single-edge) component of  $K(1, \beta(xy))$  containing  $xy$  and have one fewer bad edges, a contradiction to the minimality of  $\beta$ . We derive that  $xy$  is incident to some edge  $e$  satisfying  $\beta(e) = 1$ . Then  $e$  is necessarily ugly, as  $xy \in M$  and  $M$  is a matching.  $\square$

*Proof of Theorem 2.2.1.* Let  $\beta$  be a minimal coloring. If there is no bad edge, then  $M$  is monochromatically colored, as desired. Therefore, we assume that there is a bad edge which, by Observation 2.2.6, is incident to an ugly edge  $e$ . By Corollary 2.2.5 applied to  $e$ , there exists some free vertex  $u$  (adjacent to an endpoint of  $e$ ).

Let  $v$  be such that  $uv \in M$ , note that since  $u$  free,  $uv$  is bad, and is thus incident to an ugly edge by Observation 2.2.6. Since  $u$  cannot be incident to an ugly edge (it is free), there is some vertex  $w \in N(v)$  such that  $vw$  is ugly. We denote by  $X_v$  the sequence of vertices of  $D_v$  reached from  $vw$ , and by  $Y_w$  the sequence of vertices of  $D_w$  reached from  $vw$ .

By Lemma 2.2.4, we obtain immediately that  $X_v$  induces a cycle in  $D_v$ , and  $Y_w$  induces a cycle in  $D_w$ . By Lemmas 2.1.10 or 2.2.2, we derive that  $\beta \rightsquigarrow Y_w^{-1}(\beta)$ . Note that  $Y_w^{-1}(\beta)$  has at most as many bad and ugly edges as  $\beta$ .

By triangle-freeness,  $u$  and  $w$  are not adjacent and so  $uw$  does not appear in  $Y_w$ . Thus  $m_{Y_w^{-1}(\beta)}(v) = 1 = m_{Y_w^{-1}(\beta)}(u)$ . We swap the (single-edge) component of  $K(1, \beta(uv))$  containing the edge  $uv$ , and obtain a coloring with fewer bad edges, a contradiction.  $\square$

In the next section, we prove the general case of the conjecture (Theorem 2.1.6), the key argument of the proof is to show that for any  $(\chi'(G) + 1)$ -coloring  $\beta$  of  $G$ , and for any cycle  $X$ ,  $\beta$  and  $X^{-1}(\beta)$  are equivalent.

---

<sup>1</sup>In [AC16], this allows us to assume case A happens, avoiding case B entirely.

## 2.3 Vizing's edge-coloring conjecture: the general case

As mentioned in the end of the previous section, the main concept of this section is fans that induce cycles. Before going further, we need to introduce some notations and terminology. For legibility, when a fan  $\mathcal{X}$  induces a path (respectively a comet or a cycle), we often say that  $\mathcal{X}$  is a path (respectively a cycle or a comet). Let  $G$  be a  $\chi'(G)$ -regular graph,  $\alpha$  be a  $(\chi'(G) + 1)$ -coloring of  $G$ ,  $v$  be a vertex of  $G$ ,  $e$  be an edge incident with  $v$ . The fan around  $v$  starting at the edge  $e$  is denoted by  $X_v^\alpha(e)$  (or  $X_v^\alpha(\alpha(e))$  when it is more convenient to speak about the color of the first edge of the fan), when the coloring is clear from the context, we drop the  $\alpha$ . Note that the notion of fan as defined in the previous section is only relevant when considering  $(\chi'(G) + 1)$ -colorings of  $G$ , so from now on, unless stated otherwise, we only consider  $(\chi'(G) + 1)$ -colorings of  $G$ . If  $\mathcal{X} = (vv_1, \dots, vv_k)$  is a fan,  $v$  is called the central vertex of the fan, and  $vv_1$  and  $vv_k$  are respectively called the first and the last edge of the fan (similarly,  $v_1$  and  $v_k$  are the first and last vertex of  $\mathcal{X}$  respectively).

Given a  $(\Delta(G) + 1)$ -coloring  $\beta$  of  $G$ , and fan  $\mathcal{X} = (vv_1, \dots, vv_k)$  which is a cycle around a vertex  $v$ , where each vertex  $v_i$  misses the color  $i$  (and so each edge  $vv_i$  is colored  $(i - 1)$ ), we can define the coloring  $\beta' = X^{-1}(\beta)$  as follows:

- for any edge  $vv_i$  not in  $\mathcal{X}$ ,  $\beta'(vv_i) = \beta(vv_i)$ , and
- for any edge  $vv_i$  in  $\mathcal{X}$ ,  $\beta'(vv_i) = i$  and  $m(v_i) = i - 1$

The coloring  $X^{-1}(\beta)$  is called the *invert* of  $\mathcal{X}$ , and we say that  $X$  is *invertible* if  $\mathcal{X}$  and  $X^{-1}(\beta)$  are equivalent.

Note that if  $\mathcal{X}$  is a cycle, the missing color at the central vertex is the same in  $\alpha$  and in  $X^{-1}(\alpha)$ . If  $\mathcal{X} = (vv_1, \dots, vv_k)$  is an invertible path in a coloring  $\alpha$  inverting  $X$  means applying a sequence of single-edge Kempe swaps. Moreover, each fan  $\mathcal{Y}_i = (vv_i, \dots, vv_k)$  is also an invertible path, and when inverting a path  $\mathcal{Y}_i$ , we simply say that we invert the path  $\mathcal{X}$  until we reach a coloring  $\alpha'$  where  $m_{\alpha'}(v) = \alpha(vv_i)$ .

**Lemma 2.3.1.** *In any  $(\chi'(G) + 1)$ -coloring of a  $\chi'(G)$ -regular graph  $G$ , any cycle is invertible.*

We prove Lemma 2.3.1 in Section 2.3.1 and prove here Theorem 2.1.6. The proof of Theorem 2.1.6 is derived from the proof of Theorem 2.2.1, we first prove the following lemma which is also derived from the proof of Theorem 2.2.1.

**Lemma 2.3.2.** *In a minimal coloring, there exists a bad edge adjacent to an ugly edge, and incident with a free vertex.*



*Proof.* Let  $\beta$  be a minimal coloring, if there is no bad edge in  $\beta$ , then all the edges of  $M$  are colored 1 in  $\beta$  as desired. So there exists a bad edge  $e$  in  $\beta$ , and by Observation 2.2.6,  $e$  is adjacent to an ugly edge  $e'$ . By Corollary 2.2.5, there exists a free vertex  $u$  adjacent to an end of  $e'$ . As  $u$  is a free vertex,  $u$  is incident with a bad edge, we denote by  $v$  the neighbor of  $u$  such that the edge  $uv$  is bad. If  $v$  is a free vertex, then we swap the single edge  $uv$  to obtain a coloring with fewer bad edges, so  $v$  is not free, and thus  $uv$  is adjacent to an ugly edge; this concludes the proof.  $\square$

We are now ready to prove Theorem 2.1.6, but we first introduce some notations. Given a coloring  $\alpha$ , for any pair of colors  $a, b$ , the Kempe chain involving these two colors and containing the element  $x \in V(G) \cup E(G)$  is denoted by  $K_x^\alpha(a, b)$  (we often drop the  $\alpha$  when the coloring is clear from the context). It is important to note that if  $a, b, c$  and  $d$  are 4 different colors, then swapping a component of  $K(a, b)$  before or after swapping a component of  $K(c, d)$  does not change the coloring obtained after the two swaps.

Note also that in any coloring, a Kempe chain of  $K(a, b)$  is a connected bipartite subgraph of maximum degree 2, hence it is either a path, or an even cycle. If  $u$  is a vertex missing the color  $a$ , then  $K_u(a, b)$  is a path whose ends are  $u$  and another vertex missing either  $a$  or  $b$ . The proof of Theorem 2.1.6 is a direct consequence of the following Lemma.

**Lemma 2.3.3.** *Let  $G$  be a regular graph,  $\beta$  a  $(\Delta(G) + 1)$ -coloring of  $G$ ,  $\alpha$  be a  $\Delta(G)$ -coloring of  $G$ , and let  $c$  be a color of  $\alpha$ . Then the coloring  $\beta$  is equivalent to a  $(\Delta(G) + 1)$ -coloring  $\beta'$  where for any edge  $e$  we have  $\beta'(e) = c \Leftrightarrow \alpha(e) = c$ .*

*Proof.* Let  $\beta$  be a minimal coloring. By Lemma 2.3.2, there exists a bad edge  $uv$  such that  $u$  is free and  $v$  is incident with an ugly edge  $vw$ . By Lemma 2.2.2, the fans  $X_v(vw)$  and  $X_w(vw)$  are both cycles. The vertex  $u$  does not belong to  $X_v(vw)$ , otherwise, by Lemma 2.3.1 we invert  $X_v(vw)$  and obtain a coloring with strictly fewer bad edges. Hence, the vertex  $w$  is missing a color  $c'$  different from  $c = \beta(uv)$  (otherwise,  $X_v(vw)$  is a cycle of size 2 containing  $u$ ). Consider the component  $C = K_w(c, c')$ . Note that since  $w$  is missing the color  $c'$ , this component is a  $(c, c')$ -bichromatic path. If the component  $C$  does not contain the vertex  $v$ , then we swap it to obtain a coloring where  $w$  is missing the color of the edge  $uv$  and we are done. Thus,  $C$  contains  $v$  and we have to distinguish whether  $v$  is between  $u$  and  $w$  in  $C$  or  $u$  is between  $w$  and  $v$ .

*Case 1* ( $u$  is between  $w$  and  $v$  in  $C$ ).

In this case, by Lemma 2.3.1 we can invert  $X_v(vw)$  to obtain a coloring where the component  $K_w(c, c')$  is now a  $(c, c')$ -bichromatic cycle that we swap. In the coloring obtained after the swap,  $X_v(uv)$  is a cycle, and so by Lemma 2.3.1 we can invert it to obtain a coloring with strictly fewer bad edges; a contradiction.

Case 2 ( $v$  is between  $w$  and  $u$  in  $C$ ).

In this case, we consider the cycle  $X_w(vw)$ . If it does not contain the vertex  $u$ , we invert it by Lemma 2.3.1 and obtain a coloring where  $u$  and  $v$  are free, so it suffices to swap the edge  $uv$  to obtain a coloring with strictly fewer bad edges. Hence the vertex  $u$  belongs to  $X_w(vw)$ . After inverting this cycle, we obtain a minimal coloring where  $uv$  is still bad,  $v$  is free, and  $uw$  is ugly (the edge  $vw$  is not ugly anymore in this coloring). By Lemma 2.2.2, the fan  $X_u(uw)$  is a cycle. The situation is now similar to the previous case: we invert the cycle  $X_u(uw)$  to obtain a coloring where the component  $K_w(c, c')$  is a  $(c, c')$ -bichromatic cycle. After swapping this cycle we obtain a minimal coloring where  $X_u(uw)$  is a cycle. After inverting this cycle, we obtain a coloring with one fewer bad edge; a contradiction.

□

The rest of this section is dedicated to the proof of Lemma 2.3.1. So from now on, we do not consider anymore a minimal coloring as defined in the previous section, and thus, in the colorings considered in the rest of the paper, the notion of good, bad and ugly edge is irrelevant.

### 2.3.1 General outline and notations

It now suffices to prove Lemma 2.3.1. The proof is an induction on the size of the cycles. Towards contradiction, assume that there exist non-invertible cycles. A *minimum* cycle  $\mathcal{V}$  is a non-invertible cycle of minimum size (*i.e.*, in any coloring, any smaller cycle is invertible).

A cycle of size 2 is clearly invertible as it only consists of a single Kempe chain composed of exactly two edges: to invert the cycle, it suffices to apply a Kempe swap on this component; so the size of a minimum cycle is at least 3.

We now need some more notations. For any fan  $\mathcal{V} = (vv_1, \dots, vv_k)$ ,  $V(\mathcal{V})$  denotes the set of vertices  $\{v_1, \dots, v_k\}$ , and  $E(\mathcal{V})$  denotes the set of edges  $\{vv_1, \dots, vv_k\}$ . We denote by  $\beta(\mathcal{V})$  the set of colors involved in  $\mathcal{V}$  (*i.e.*  $\beta(\mathcal{V}) = \beta(E(\mathcal{V})) \cup m(V(\mathcal{V})) \cup m(v)$ ); if  $\mathcal{V}$  involves the color  $c$ ,  $M(X, c)$  denotes the vertex of  $V(\mathcal{V})$  missing the color  $c$ . There is a natural order induced by a fan on its vertices (respectively on its edges), and if  $i < j$  we say that the vertex  $v_i$  (respectively the edge  $vv_i$ ) is before the vertex  $v_j$  (respectively the edge  $vv_j$ ). For two vertices  $v_i$  and  $v_j$  of  $\mathcal{V}$  we define the *subfan*  $\mathcal{V}_{[v_i, v_j]}$  as the subsequence  $(vv_i, vv_{i+1}, \dots, vv_j)$ . We often write  $\mathcal{V}_{\geq v_i}$ ,  $\mathcal{V}_{> v_i}$ ,  $\mathcal{V}_{\leq v_i}$  and  $\mathcal{V}_{< v_i}$  to respectively denote the subfans  $(v_i, \dots, v_k)$ ,  $(v_{i+1}, \dots, v_k)$ ,  $(v_1, \dots, v_i)$ , and  $(v_1, \dots, v_{i-1})$ .

If the fan  $\mathcal{V}$  is a cycle in a coloring  $\beta$ , inverting  $\mathcal{V}$  means applying a sequence of Kempe swaps to obtain the coloring  $X^{-1}(\beta)$ . If  $\mathcal{V}$  is a fan which is a path, inverting  $\mathcal{V}$  means applying a sequence of single-edge Kempe swaps on the edges

of  $\mathcal{V}$  such that the ends of the first edge of  $\mathcal{V}$  are missing the same color  $\beta(vv_1)$ . Note that we often only partially invert paths, *i.e.* we apply a sequence of single-edge Kempe swaps on the edges of the paths until we reach a coloring with a specific missing color at the central vertex.

Recall that a cycle  $\mathcal{V} = (vv_1, \dots, vv_k)$  is called *saturated* if for any  $i, v_i \in K_v(m(v), m(v_i))$ . Lemma 2.3 of [BDK<sup>+</sup>21], which we restate here, guarantees that if a cycle is not invertible, then it is saturated.

Lemma 2.1.10 directly implies the following result for any minimum cycle.

**Lemma 2.3.4.** *Any minimum cycle is saturated.*

Let  $X \subseteq E(G) \cup V(G)$ ,  $\beta$  a coloring and  $\beta'$  a coloring obtained from  $\beta$  by swapping a component  $C$ . The component is called  $X$ -stable if :

- for any  $v \in X$ ,  $m^\beta(v) = m^{\beta'}(v)$ , and
- for any  $e \in X$ ,  $\beta(e) = \beta'(e)$ .

In this case, the coloring  $\beta'$  is called  $X$ -identical to  $\beta$ .

If  $S = (C_1, \dots, C_k)$  is a sequence of swaps to transform a coloring  $\beta$  into a coloring  $\beta'$  where each  $C_j$  is a Kempe component. The sequence  $S^{-1}$  is defined as the sequence of swaps  $(C_k, \dots, C_1)$ . Such a sequence is called  $X$ -stable if each  $C_j$  is  $X$ -stable.

**Observation 2.3.5.** *Let  $X \subseteq V(G) \cup E(G)$ , and  $S$  a sequence of swaps that is  $X$ -stable. Then the sequence  $S^{-1}$  is also  $X$ -stable.*

If a sequence  $S$  is  $X$ -stable, then the coloring obtained after applying  $S$  to  $\beta$  is called  $X$ -equivalent to  $\beta$ . Note that the notion of  $X$ -equivalence is stronger than the notion of  $X$ -identity. Since two colorings  $\beta$  and  $\beta'$  may be  $X$ -identical but not  $X$ -equivalent if there exists a coloring  $\beta''$  in the sequence between  $\beta$  and  $\beta'$  that is not  $X$ -identical to  $\beta$ . We first have the following observation that we will often use in this paper.

**Observation 2.3.6.** *Let  $\mathcal{X}$  be a subfan in a coloring  $\beta_0$ ,  $v$  be a vertex which is not in  $V(\mathcal{X})$ , and  $S = (C_1, \dots, C_k)$  be a sequence of trivial swaps of edges incident with  $v$ ,  $(\beta_1, \dots, \beta_k)$  be the colorings obtained after each swap of  $S$ . If for any  $i \in \{0, \dots, k\}$ ,  $m^{\beta_i}(v) \notin \beta_0(\mathcal{X})$ , then the sequence  $S$  is  $(\mathcal{X})$ -stable.*

*Proof.* Otherwise, assume that  $S$  is not  $\mathcal{X}$ -stable. Since the vertex  $v$  is not in  $V(\mathcal{X})$ , then no edge of  $\mathcal{X}$  has been changed during the sequence of swap. Thus the missing color of a vertex of  $\mathcal{X}$  has been changed during the sequence of swaps, we denote by  $x$  the first such vertex. Let  $s_i$  be the swap that change the color of the edge  $vx$ , it means that in the coloring  $\beta_{i-1}$  the vertices  $v$  and  $x$  are missing the same color, so  $m^{\beta_{i-1}}(v) \in \beta_0(\mathcal{X})$ ; a contradiction.  $\square$

The following observation gives a relation between  $X$ -equivalence and  $(G \setminus X)$ -identity between colorings.

**Observation 2.3.7.** *Let  $\beta$  be a coloring,  $X \subseteq V(G) \cup E(G)$ ,  $\beta_1$  a coloring  $X$ -equivalent to  $\beta$ , and  $\beta_2$  a coloring  $(G \setminus X)$ -identical to  $\beta_1$ . Then, there exists a coloring  $\beta_3$  equivalent to  $\beta_2$  that is  $X$ -identical to  $\beta_2$  and  $(G \setminus X)$ -identical to  $\beta$ .*

*Proof.* Let  $S$  be the sequence of swaps that transforms  $\beta$  into  $\beta_1$ . Since  $\beta_1$  is  $X$ -equivalent to  $\beta$ , the sequence  $S$  is  $X$ -stable and thus  $E(S) \cap E(X) = V(S) \cap V(X) = \emptyset$ . Since  $\beta_2$  is  $(G \setminus X)$ -identical to  $\beta_1$ , it is  $S$ -identical to  $\beta_1$ . So applying  $S^{-1}$  to  $\beta_2$  is well-defined and gives a coloring  $\beta_3$   $S$ -identical to  $\beta$ . We first prove that  $\beta_3$  is  $(G \setminus X)$ -identical to  $\beta$ . The coloring  $\beta_1$  is  $(G \setminus S)$ -identical to the coloring  $\beta$  by definition of  $S$ , and the coloring  $\beta_2$  is  $(G \setminus X)$ -identical to  $\beta_1$ , so the coloring  $\beta_2$  is  $(G \setminus (X \cup S))$ -identical to  $\beta$ . Again by definition of  $S^{-1}$  the coloring  $\beta_3$  is  $(G \setminus S)$ -identical to  $\beta_2$ , so it is  $(G \setminus (S \cup X))$ -identical to  $\beta$ . Since the coloring  $\beta_3$  is also  $S$ -identical to  $\beta$ , in total, it is  $(G \setminus X)$ -identical to  $\beta$ .

We now prove that  $\beta_3$  is  $X$ -identical to  $\beta_2$ . Since  $E(S) \cap E(X) = V(S) \cap V(X) = \emptyset$ , we have that  $E(X) \subseteq E(G) \setminus E(S)$  and  $V(X) \subseteq V(G) \setminus V(S)$ . Moreover, the coloring  $\beta_3$  is  $(G \setminus S)$ -identical to  $\beta_2$  by definition of  $S$ , so the coloring  $\beta_3$  is  $X$ -identical to  $\beta_2$  as desired.  $\square$

If  $\mathcal{X}$  is a fan, when two colorings are  $(V(\mathcal{X}) \cup E(\mathcal{X}))$ -identical (respectively  $(V(\mathcal{X}) \cup E(\mathcal{X}))$ -equivalent), we simply write that the two colorings are  $\mathcal{X}$ -identical (respectively  $\mathcal{X}$ -equivalent). Similarly, if two colorings are  $((V(G) \cup E(G)) \setminus X)$ -identical (respectively  $((V(G) \cup E(G)) \setminus X)$ -equivalent), we simply write that the two colorings are  $(G \setminus X)$ -identical (respectively  $(G \setminus X)$ -equivalent).

Remark that if  $\mathcal{V}$  is a cycle in a coloring  $\beta$ , then the coloring  $\mathcal{V}^{-1}(\beta)$  is  $(G \setminus \mathcal{V})$ -identical to  $\beta$ . So from the previous observation we have the following corollary.

**Corollary 2.3.8.** *Let  $\mathcal{V}$  be a cycle in a coloring  $\beta$ . If there exists a coloring  $\beta'$   $\mathcal{V}$ -equivalent to  $\beta$  where  $\mathcal{V}$  is invertible, then  $\mathcal{V}$  is invertible in  $\beta$ .*

*Proof.* Let  $\beta'' = \mathcal{V}^{-1}(\beta')$ . The coloring  $\beta'$  is  $\mathcal{V}$ -equivalent to  $\beta$  and  $\beta''$  is  $(G \setminus \mathcal{V})$ -identical to  $\beta'$ . So by Observation 2.3.7 there exists a coloring  $\beta_3$  that is  $\mathcal{V}$ -identical to  $\beta''$  and  $(G \setminus \mathcal{V})$ -identical to  $\beta$ . So the coloring  $\beta_3$  is  $(G \setminus \mathcal{V})$ -identical to  $\mathcal{V}^{-1}(\beta)$ .

Moreover, the coloring  $\beta''$  is  $\mathcal{V}$ -identical to  $\mathcal{V}^{-1}(\beta)$ , so the coloring  $\beta_3$  is also  $\mathcal{V}$ -identical to  $\mathcal{V}^{-1}(\beta)$ . Therefore we have  $\beta_3 = \mathcal{V}^{-1}(\beta)$  as desired.  $\square$

From the previous corollary, we have the following observation.

**Observation 2.3.9.** *Let  $\mathcal{V}$  be a minimum cycle in coloring  $\beta$ , and  $\beta'$  a coloring  $\mathcal{V}$ -equivalent to  $\beta$ . Then in the coloring  $\beta'$ , the sequence  $\mathcal{V}$  is also a minimum cycle such that for any  $e \in E(\mathcal{V})$ ,  $\beta(e) = \beta'(e)$ , and for any  $v \in V(\mathcal{V})$ ,  $m^\beta(v) = m^{\beta'}(v)$ .*

We often simply say that the cycle  $\mathcal{V}$  is the same minimum cycle in the coloring  $\beta'$ .

A cycle  $\mathcal{V} = (vv_1, \dots, vv_k)$  is called *tight* if for every  $i$   $v_i \in K_{v_{i-1}}(m(v_i), m(v_{i-1}))$ . A simple observation is that any minimum cycle  $\mathcal{V}$  is tight.

**Observation 2.3.10.** *Let  $\mathcal{V} = (vv_1, \dots, vv_k)$  be a minimum cycle in a coloring  $\beta$ . Then the cycle  $\mathcal{V}$  is tight.*

*Proof.* Assume that  $\mathcal{V}$  is not tight, so there exists  $i$  such that  $v_i \notin K_{v_{i-1}}(m(v_i), mv_{i-1})$ . Without loss of generality, we assume that  $i = 2$  and that each  $v_j$  is missing the color  $j$ . Note that this means that  $\beta(vv_2) = 1$ ,  $\beta(vv_3) = 2$  and  $\beta(vv_1) = k$ .

We swap the component  $C_{1,2} = K_{v_1}(1, 2)$  to obtain a coloring  $\beta'$  that is  $(\mathcal{V} \setminus \{v_1\})$ -equivalent to the coloring  $\beta$ . Thus each  $v_j$  is missing the color  $j$  except  $v_1$  which is now missing the color 2. So now the fan  $\mathcal{V}' = X_v(k)$  is equal to  $(vv_1, vv_3, \dots, vv_k)$ , and thus is a cycle strictly smaller than  $\mathcal{V}$ . Since  $\mathcal{V}$  is minimum, this cycle is invertible, and we denote by  $\beta''$  the coloring obtained after its inversion.

The coloring  $\beta''$  is  $(G \setminus \mathcal{V}')$ -identical to the coloring  $\beta'$ , so in particular it is  $C_{1,2}$ -identical to the coloring  $\beta'$ . Moreover, the coloring  $\beta''$  is  $(\mathcal{V} \setminus \{vv_1, vv_2, v_2\})$ -identical to the coloring  $\mathcal{V}^{-1}(\beta)$ , and we have  $\beta''(vv_1) = 2$ ,  $\beta''(vv_2) = 1$ , and  $m^{\beta''}(v_2) = 2$ .

So now in this coloring the component  $K_{v_1}(1, 2)$  is exactly  $C_{1,2} \cup \{vv_1, vv_2\}$ , and we swap back this component to obtain a coloring  $\beta'''$ . The coloring  $\beta'''$  is now  $C_{1,2}$ -identical to  $\beta$ , and thus it is  $(G \setminus \mathcal{V})$ -identical to  $\beta$ . Moreover, it is  $(\mathcal{V} \setminus \{vv_1, vv_2, v_2\})$ -identical to  $\beta''$ , so it is  $(\mathcal{V} \setminus \{vv_1, vv_2, v_2\})$ -identical to  $\mathcal{V}^{-1}(\beta)$ . Finally, we have  $\beta'''(vv_1) = 1 = m^\beta(v_1)$ ,  $\beta'''(vv_2) = 2 = m^\beta(v_2)$ , and  $m^{\beta'''}(v_2) = 1 = \beta(vv_2)$ , so the coloring  $\beta'''$  is  $\mathcal{V}$ -identical to  $\mathcal{V}^{-1}(\beta)$ . Since it is also  $(G \setminus \mathcal{V})$ -identical to  $\beta$ , we have  $\beta''' = \mathcal{V}^{-1}(\beta)$  as desired.  $\square$

The proof of Lemma 2.3.1, is a consequence of the two following Lemmas.

**Lemma 2.3.11.** *Let  $\mathcal{V}$  be a minimum cycle. For any color  $c$  different from  $m(v)$ , the fan  $X_v(c)$  is a cycle.*

**Lemma 2.3.12.** *Let  $\mathcal{X}$  and  $\mathcal{Y}$  be two cycles around a vertex  $v$ . For any pair of vertices  $(z, z')$  in  $(\mathcal{V} \cup \mathcal{X} \cup \mathcal{Y})^2$ , the fan  $\mathcal{Z} = X_z(c_{z'})$  is a cycle containing  $z'$ .*

We prove Lemma 2.3.11 in section 2.3.2, and Lemma 2.3.12 in section 2.6, and prove here Lemma 2.3.1.

*Proof of Lemma 2.3.1.* To prove the Lemma, we prove that the graph  $G$  only consists of an even clique where each vertex misses a different color. This is a contradiction since in any  $(\Delta(G) + 1)$ -coloring of an even clique, for any color  $c$ , the number of vertices missing the color  $c$  is always even. By Lemma 2.3.11, all the fans around  $v$  are cycles, so each neighbor of  $v$  misses a different color. Moreover, by Lemma 2.3.12, there is an edge between each pair of neighbors of  $v$ , so  $G = N[v] = K_{\Delta(G)+1}$ . By construction,  $G$  is  $\Delta(G)$ -colorable, so  $G$  is an even clique and each vertex misses a different color, this concludes the proof.  $\square$

### 2.3.2 Only cycles around $v$ : a proof of lemma 2.3.11

In this section, we prove Lemma 2.3.11. If  $\mathcal{X}$  and  $\mathcal{X}'$  are two fans, then  $\mathcal{X}$  and  $\mathcal{X}'$  are called *entangled* if for any  $c \in \beta(\mathcal{X}) \cap \beta(\mathcal{X}')$ ,  $M(\mathcal{X}, c) = M(\mathcal{X}', c)$ . To prove Lemma 2.3.11 we need the two following lemmas.

**Lemma 2.3.13.** *Let  $\mathcal{V}$  be a minimum cycle in a coloring  $\beta$  and let  $u$  and  $u'$  be two vertices of  $\mathcal{V}$ . Then fan  $\mathcal{U} = X_u(m(u')) = (uu_1, \dots, uu_l)$  is a cycle entangled with  $\mathcal{V}$ .*

**Lemma 2.3.14.** *Let  $\mathcal{V}$  be a minimum cycle in a coloring  $\beta$ ,  $u$  and  $u'$  be two vertices of  $\mathcal{V}$ , and  $\mathcal{U} = X_u(m(u')) = (uu_1, \dots, uu_l)$ . Then for any  $j \leq l$ , the fan  $X_v(\beta(uu_j))$  is a cycle.*

Note that by Lemma 2.3.13, we can directly conclude that  $N[v]$  is a clique. Moreover, we directly have the following corollary.

**Corollary 2.3.15.** *Let  $\mathcal{V} = (vv_1, \dots, vv_k)$  be a minimum cycle in a coloring  $\beta$ . Then for any  $j \leq k$ , the fan  $X_u(m(v))$  is a cycle entangled with  $\mathcal{V}$ .*

*Proof.* Let  $j \leq k$  and  $\mathcal{U} = X_{v_j}(m(v_{j-1})) = X_{v_j}(\beta(vv_j))$ . Then the first edge of  $\mathcal{U}$  is  $vv_j$ , and since  $v$  is missing the color  $m(v)$ , the second edge of  $\mathcal{U}$  is colored  $m(v)$ . By Lemma 2.3.13,  $\mathcal{U}$  is a cycle entangled with  $\mathcal{V}$ , so since  $X_u(m(v)) = \mathcal{U}$ , the fan  $X_u(m(v))$  is a cycle entangled with  $\mathcal{V}$  as desired.  $\square$

We prove Lemma 2.3.13 in Section 2.4, Lemma 2.3.14 in Section 2.5, and prove here Lemma 2.3.11.

*Proof of Lemma 2.3.11.* Assume that there exists a fan  $\mathcal{W} = (vw_1, \dots, vw_t)$  around  $v$  which does not induce a cycle, we first prove that  $\mathcal{W}$  is not a path.

**Claim 1.** *The fan  $\mathcal{W}$  cannot induce a path.*

*Proof.* Without loss of generality, we assume that the vertex  $v$  is missing the color 1. Assume that  $\mathcal{W}$  induces a path, so  $m(v) = m(w_t) = 1$ . Let  $v' \in \mathcal{V}$ , by Corollary 2.3.15, we have that  $\mathcal{U} = X_{v'}(1)$  is a cycle containing  $v$  in  $\beta$ . If we apply a single-edge Kempe swap on  $vw_t$ , then we obtain a coloring where  $m(w_t) = m(v) = \beta(vw_t)$ ; we denote by  $\beta'$  this coloring, and without loss of generality, we assume that  $\beta(vw_t) = 2$ . Again, by Corollary 2.3.15, we also have that  $\mathcal{U}' = X_{v'}(2)$  is a cycle containing  $v$  in the coloring  $\beta'$ , so  $\mathcal{U} \cap \mathcal{U}' \neq \emptyset$ , let  $v'w''$  be the first edge they have in common, and let  $w = M(\mathcal{U}, \beta(v'w''))$  and  $w' = M(\mathcal{U}', \beta(v'w''))$ . We now have to distinguish whether  $v \in \{w, w'\}$  or not.

*Case 3* ( $v \notin \{w, w'\}$ ).

In this case,  $m_\beta(w) = m_{\beta'}(w) = m_\beta(w') = m_{\beta'}(w')$ ; we denote by  $c$  this color. By Lemma 2.3.14,  $X_v(c)$  is a cycle containing  $w$  in  $\beta$ , and  $X_v(c)$  is a cycle containing  $w'$  in  $\beta'$ , so  $w = w'$ ; a contradiction.

*Case 4* ( $v \in \{w, w'\}$ ).

The case  $v = w$  and  $v = w'$  being symmetrical, we can assume that  $v = w$ . In this case, in the coloring  $\beta'$ ,  $w'$  is missing the color  $c_v$ , but by Lemma 2.3.14  $X_v(1)$  is a cycle containing  $w$  or  $\mathcal{V}$  is invertible, however, in the coloring  $\beta'$ ,  $X_v(1)$  induces a path which is a single edge; a contradiction. □

Thus the fan  $\mathcal{W}$  is not a path. Now assume that  $\mathcal{W}$  is a comet, then there exists  $w$  and  $w'$  in  $\mathcal{W}$  which are missing the same color  $c$ . At least one of them is not in  $K_v(1, c)$ , the two cases being symmetrical, we can assume without loss of generality that  $w$  is not in  $K_v(1, c)$ . So if we swap the component  $K_w(1, c)$ , we obtain a coloring where the fan  $X_v(\beta(vw_1))$  is a path; a contradiction, so  $\mathcal{W}$  is a cycle. □

## 2.4 Fans around $\mathcal{V}$ : a proof of Lemma 2.3.13

In this section, we prove Lemma 2.3.13 which will be often used in the proof of Lemma 2.3.14.

*Proof of Lemma 2.3.13.* We first prove that the fan  $\mathcal{U}$  cannot induce a path.

**Claim 2.** *The fan  $\mathcal{U}$  cannot induce a path.*

*Proof.* Otherwise, assume that the fan  $\mathcal{U}$  is a path, without loss of generality, we can assume that  $\mathcal{U}$  is of minimal length (if  $\mathcal{U}$  is not minimal, since it is a path, it contains a strictly smaller path). Thus  $\mathcal{U}$  contains only one edge colored with a color in  $\beta(\mathcal{V}) \setminus \{c_v\}$ : its first edge. We now need to distinguish whether  $j' = j - 1$  or not (i.e. whether  $u = v_j$  and  $u' = v_{j'}$  are consecutive or not in  $\mathcal{V}$ ).

*Case 1* ( $j' = j - 1$ ).

In this case,  $\mathcal{U} = X_u(uv)$ , and the edge colored  $c_v$  incident with  $u$  is just after  $uv$  in  $\mathcal{U}$ . As  $\mathcal{U}$  is a path, we can invert it until we reach a coloring where  $m(u) = m(v) = c_v$ . Since  $\mathcal{U}$  is minimal, no edge incident with a vertex of  $\mathcal{V}$  different from  $u$  has been recolored during the inversion. In the coloring obtained after the inversion, the fan  $(vv_{j+1}, \dots, vv_j = vu)$  is a path that we can invert until we reach a coloring where  $m(v) = m(v_{j+1}) = j$ , we denote by  $\beta'$  this coloring. Since  $\mathcal{V}$  was tight in the coloring  $\beta$ , in the coloring  $\beta'$  we have  $C = K_{v_{j-1}}^{\beta'}(j, j-1) = K_{v_{j-1}}^{\beta}(j, j-1) \cup \{vv_{j-1}\} \setminus \{vv_{j+1}, vv_j = vu\}$ , so we swap this component to obtain a coloring where  $m(v) = m(u) = j - 1$ , then we swap the edge  $uv$  and obtain a coloring where  $(uu_{l-1}, \dots, uu_0)$  is a path that we invert. In the coloring obtained after the inversion, we have that the component  $K_{v_{j-1}}(j, j-1)$  is exactly  $C \cup \{vv_j\}$ , if we swap this component back we obtain exactly  $\mathcal{V}^{-1}(\beta)$ .

*Case 2* ( $j' \neq j - 1$ ).

In this case, since  $\mathcal{U}$  is a path, we can invert it until we reach a coloring  $\beta'$  where  $m(u) = c_u = j'$ . Note that, similarly to the previous case, this inversion has not changed the colors of the edges incident with the vertices of  $\mathcal{V}$ , except those incident with  $u$ . We now consider the component  $K_v(j', c_v)$  (which can have changed during the inversion of  $\mathcal{U}$  as we swapped an edge colored  $j'$ ), and we need to distinguish whether or not the vertices  $u'$  and  $u$  belong to this component; clearly these vertices does not both belong to this component.

*Subcase 2.1* ( $u' \notin K_v(j', c_u)$ ).

In this case, we swap the component  $C = K_{u'}(j', c_v)$  to obtain a coloring where  $(vv_{j+1}, \dots, vv_{j'})$  is a path that we invert until we reach a coloring where  $m(v) = m(v_{j+1}) = c_u$ , we denote by  $\beta'$  this coloring. As  $\mathcal{V}$  was tight in  $\beta$ , we have that  $C_j = K_{v_{j-1}}^{\beta'}(j, j-1) = K_{v_{j-1}}^{\beta}(j, j-1) \setminus \{vv_{j+1}, vv_j = vu\}$ , so we swap this component to obtain a coloring where  $(vv_{j'+1}, \dots, vv_{j-1})$  is a path that we invert until we reach a coloring where  $m(v) = m(v_{j'+1}) = j'$ . In the coloring obtained after the inversion, the component  $K_{u'}(j', c_v)$  is exactly  $C \cup \{vu'\}$ , thus we swap it back. Note that as  $|\{c_{u'}, c_v, j, j-1\}| = 4$ , we can swap back  $C$  before  $C_j$ . In the coloring obtained after swapping back the component, we have that the fan  $(uu_{l-1}, \dots, uu_0)$  is a path that we invert. In the coloring obtained after the inversion, the component  $K_{v_{j-1}}(j, j-1)$  is exactly  $C \cup \{vv_{j-1}, vv_j = vu\}$ , thus we swap back this component and obtain exactly  $\mathcal{V}^{-1}(\beta)$ .

So  $u'$  belongs to the component  $K_v(j', c_u)$ .

*Subcase 2.2* ( $u \notin K_v(c_{u'}, c_u)$ ).

In this case, we swap the component  $C = K_u(j', c_v)$ , note that, from the previous case, neither  $v$  nor  $u'$  belong to this component. In the coloring obtained after the swap, the fan  $(vv_{j+1}, \dots, vv_j)$  is a path that we invert until we reach a coloring where  $m(v) = m(v_{j+1}) = c_u$ ; we denote by  $\beta'$  this coloring. As  $\mathcal{V}$  was tight in  $\beta$ ,



## 2. Vizing's edge-coloring conjecture

---

we have that  $C_j = K_{v_{j-1}}^{\beta'}(j, j-1) = K_{v_{j-1}}^\beta(j, j-1) \cup \{vv_{j-1}\} \setminus \{vv_{j+1}, vv_j = vu\}$ , so we swap this component to obtain a coloring where  $m(v) = m(u) = j-1$ , then we swap the edge  $uv$  to obtain a coloring where  $K_u(c_{u'}, c_v)$  is exactly  $C$ . Hence we swap back this component, and in the coloring obtained after the swap, the fan  $(uu_{l-1}, \dots, uu_0)$  is a path that we invert until we reach a coloring where  $m(u) = j$ . In this coloring, the component  $K_{v_{j-1}}(j, j-1)$  is exactly  $C_j \cup \{vv_{j-1}, vv_j = vu\}$ , thus we swap back this component to obtain exactly  $\mathcal{V}^{-1}(\beta)$ .  $\square$

Before proving that the fan  $\mathcal{U}$  is not a comet, we prove that  $\mathcal{U}$  and  $\mathcal{V}$  are entangled.

**Claim 3.** *The fans  $\mathcal{U}$  and  $\mathcal{V}$  are entangled.*

*Proof.* Assume that  $\mathcal{U}$  and  $\mathcal{V}$  are not entangled, then there exist  $w = v_s \in \mathcal{V}$  and  $w' = u_{s'} \in \mathcal{U}$  distinct from  $w$  with  $m(w) = m(w') = c$ . If  $m(w) = m(v) = c_v$ , then, since  $\mathcal{V}$  is saturated,  $w \in K_v(c_v, c)$ , so we swap  $K_{w'}(c_v, c)$  to obtain a coloring where  $\mathcal{V}$  is still a cycle of the same size, but where  $X_u(c_{u'})$  is a path, by the previous claim, this is a contradiction.

So  $m(w) \neq m(v)$ , and therefore, we successively swap the components  $K_{w'}(t, t+1)$  with  $t \in (s, \dots, j)$ . Note that this sequence of swaps has not changed the colors of the edges incident with a vertex of  $\mathcal{V}$ ; it can though have changed the colors of the edges of  $\mathcal{U}$ . However, it is guaranteed that in the coloring obtained after the swaps, there exists a color  $c' \in \beta(\mathcal{V})$  such that  $X_u(c')$  is a path, which is a contradiction by the previous claim.  $\square$

We now prove that  $\mathcal{U}$  is not a comet.

**Claim 4.** *The fan  $\mathcal{U}$  is not a comet.*

*Proof.* Assume that  $\mathcal{U}$  is a comet, then there exist  $w$  and  $w'$  in  $\mathcal{U}$  with  $m(w) = m(w') = c$  and where  $w'$  is after  $w$  in the sequence. By the previous claim, as  $\mathcal{U}$  and  $\mathcal{V}$  are entangled, we have that  $c \notin \beta(\mathcal{V})$ . We now consider the component  $C_v = K_v(c, c_v)$ . If  $w'$  is not in  $C_v$ , then we swap  $C_{w'} = K_{w'}(c, c_v)$  to obtain a coloring where  $w'$  belongs to the fan  $X_u(c_{u'})$  with  $m(w') = m(v)$ ; this contradicts the fact that  $X_u(c_{u'})$  and  $\mathcal{V}$  are entangled. Note that if  $u$  is in  $C'$ , and  $m(v) \in \beta(\mathcal{U})$ , after swapping  $C'$  the sequence  $X_u(c_{u'})$  now starts at the edge colored  $c$  in  $\beta$ , but this does not change the reasoning. So the vertex  $w'$  belongs to  $C$ , and thus the vertex  $w$  does not belong to  $C_v$ , so we can swap  $C_w = K_w(c, c_v)$  to obtain a coloring where the sequence  $X_u(m(u'))$  contains  $w$  which is missing the color  $m(v)$ , a contradiction. Note that if  $u \in C_w$ , then after swapping  $C_w$ , we obtain a coloring where  $w'$  comes before  $w$  in the fan  $X_u(m(u'))$ . Similarly to the previous case, this does not change the reasoning.  $\square$

From the previous claims, the fan  $\mathcal{U}$  is a cycle entangled with  $\mathcal{V}$  as desired.  $\square$

## 2.5 Cycles around $v$ starting with $u$ : a proof of Lemma 2.3.14

In this section we prove Lemma 2.3.14. To prove the lemma we actually prove a stronger statement, but we need first some definitions.

**Definition 2.5.1.** *Let  $i \geq 0$ , we define the property  $P_{weak}(i)$  as the following: For any minimum cycle  $\mathcal{V}$  in a coloring  $\beta$ , for any pair of vertices  $u$  and  $u'$  of  $\mathcal{V}$ , let  $\mathcal{U} = X_u(m(u')) = (uu_1, \dots, uu_l)$ . If  $\beta(uu_{l-i}) \neq m(v)$ , then  $X_v(\beta(uu_{l-i}))$  is not a path.*

**Definition 2.5.2.** *Let  $i \geq 0$ , we define the property  $P(i)$  as follows:*

*For any minimum cycle  $\mathcal{V}$  in a coloring  $\beta$ , for any pair of vertices  $u$  and  $u'$  of  $\mathcal{V}$ , let  $\mathcal{U} = X_u(m(u')) = (uu_1, \dots, uu_l)$ . If  $\beta(uu_{l-i}) \neq m(v)$ , then the fan  $X_v(\beta(uu_{l-i}))$  is a saturated cycle containing  $u_{l-i-1}$ ,*

Lemma 2.3.14 is a direct consequence of the following lemma.

**Lemma 2.5.3.** *The property  $P(i)$  is true for all  $i$ .*

The proof of the lemma is an induction on  $i$ . However, before starting to prove the lemma, we need to introduce the notion of  $(\mathcal{V}, u)$ -independent fan for a vertex  $u$  of a cycle  $\mathcal{V}$ .

### 2.5.1 $(\mathcal{V}, u)$ -independent fans

Let  $\mathcal{V}$  be a minimum cycle in a coloring  $\beta$ , and  $u$  a vertex of  $\mathcal{V}$ . A  $(\mathcal{V}, u)$ -independent subfan  $\mathcal{X}$  is a subfan around  $v$  such that  $\beta(\mathcal{V}) \cap \beta(\mathcal{X}) = \{\beta(u)\}$ . We naturally define a  $(\mathcal{V}, u)$ -independent path (respectively a  $(\mathcal{V}, u)$ -independent cycle) as a  $(\mathcal{V}, u)$ -independent subfan that is also a path (respectively a cycle). If  $v$  is a vertex not in  $\mathcal{X}$  missing a color  $c$ , we say that  $\mathcal{X}$  avoids  $v$  if the last vertex of  $\mathcal{X}$  is also missing the color  $c$ .

We first prove the following.

**Lemma 2.5.4.** *Let  $\mathcal{V}$  be a minimum cycle in a coloring  $\beta$ ,  $u$  a vertex of  $\mathcal{V}$ ,  $\mathcal{Y} = (uy_1, \dots, uy_r)$  a  $(\mathcal{V}, u)$ -independent subfan avoiding  $v$  and  $x$  the extremity of  $K_{y_s}(m(u), m(v))$  which is not  $y_r$ . Then the fan  $X_v(\beta(uy_1))$  is a path containing  $x$  which is missing the color  $m(v)$ .*

We decompose the proof into five separate lemmas.

*Proof of Lemma 2.5.4.* Without loss of generality, we assume that the vertices  $v$  and  $u$  are respectively missing the colors 1 and 2, and that  $\beta(uy_1) = 4$ . Since the fan  $\mathcal{V}$  is a minimum cycle in the coloring  $\beta$ , it is saturated by Lemma 2.3.4, so  $u \in K_v(1, 2)$  and thus  $y_r \notin K_v(1, 2)$ . We now swap the component  $C_{1,2} = K_{y_r}(1, 2)$  to obtain a coloring  $\mathcal{V}$ -equivalent to  $\beta$ , where  $\mathcal{V}$  is now a  $(\mathcal{V}, u)$ -independent path. By Lemma 2.5.9, the fan  $X_v(4)$  is a comet containing the other extremity of  $K_{y_r}(1, 2)$  which is  $x$ . In this coloring, the vertex  $x$  is missing the color 2, therefore in the coloring  $\beta$ , the fan  $X_v(4)$  is a path containing  $x$  which is missing the color 1 as desired.  $\square$

**Lemma 2.5.5.** *Let  $\mathcal{X} = (vv_1, \dots, vv_k)$  be a path of length at least 3 in a coloring  $\beta$ ,  $u = v_i$  for some  $i \in [3, k]$ ,  $u'' = v_{i-1}$ ,  $u' = v_1$ , and  $C$  a  $(\beta(vu), m(u))$ -bichromatic path between  $u''$  and  $u'$  that does not contain  $v$ . Then  $\beta$  is equivalent to a coloring  $\beta'$  such that:*

- $\beta'$  is  $(G \setminus (C \cup \mathcal{X}))$ -identical to  $\beta$ ,
- $\beta'$  is  $(\mathcal{X}_{\geq u})$ -identical to  $\beta$ ,
- for any edge  $j \in [2, i - 1]$ ,  $m^{\beta'}(v_j) = \beta(vv_j)$ ,
- $m^{\beta'}(u') = \beta(vu)$ ,
- for any edge  $j \in [1, i - 2]$ ,  $\beta'(vv_j) = m^\beta(v_j)$ ,
- $\beta'(vu'') = \beta(vu')$ ,
- for any edge  $e \in C$ :
  - if  $\beta(e) = \beta(vu)$ , then  $\beta'(e) = m^\beta(u)$ , and
  - if  $\beta(e) = m^\beta(u)$ , then  $\beta'(e) = \beta(vu)$ .

*Proof.* Without loss of generality, we assume that the vertices  $v$  is missing the color 1, that the edge  $vu'$  is colored 2, and that the edge  $vu$  is colored 3. Note that this means that  $m(u'') = 3$ . In the coloring  $\beta$ , the fan  $\mathcal{X}$  is a path, so we invert this path, and denote by  $\beta_2$  the coloring obtained after the inversion. The coloring  $\beta_2$  is  $(G \setminus \mathcal{X})$ -identical to the coloring  $\beta$  so  $C$  is still a  $(2, 3)$ -bichromatic path between  $u'$  and  $u''$  that does not contain  $v$ . Moreover, for any edge  $j \in [1, i]$ ,  $\beta_2(vv_j) = m^\beta(v_j)$  and  $m^{\beta_2}(v_j) = \beta(vv_j)$ . So the coloring  $\beta_2$  is  $(\mathcal{X}_{[v_2, v_{i-2}]} \cup \{u'', vu'\})$ -identical to  $\beta'$ . The vertex  $u'$  is now missing the color 2, and the edge  $vu''$  is now colored 3. Moreover, the vertex  $v$  is now missing the color 2, so  $K_v(2, 3) = C \cup \{vu''\}$ . We now swap this component and denote by  $\beta_3$  the coloring obtained after the swap.

The coloring  $\beta_3$  is  $(G \setminus (C \cup \mathcal{X}))$ -identical to the coloring  $\beta$ , so it is  $(G \setminus (C \cup \mathcal{X}))$ -identical to  $\beta'$ . Moreover, for any edge  $e \in C$ :

- if  $\beta(e) = 2$ , then  $\beta_3(e) = 3$ , and
- if  $\beta(e) = 3$ , then  $\beta_3(e) = 2$ .

So the coloring  $\beta_3$  is also  $C$ -identical to  $\beta'$ ; thus it is  $(G \setminus \mathcal{X})$ -identical to  $\beta'$ .

The coloring  $\beta_3$  is  $(\mathcal{X}_{[v_2, v_{i-2}]} \cup \{u'', vu''\})$ -identical to  $\beta_2$ , so it is  $(\mathcal{X}_{[v_2, v_{i-2}]} \cup \{u'', vu''\})$ -identical to  $\beta'$ . In the coloring  $\beta_3$ , the edge  $vu''$  is now colored 2, and the vertex  $u'$  is now missing the color 3. So the coloring  $\beta_3$  is also  $(\{vu'', u'\})$ -identical to  $\beta'$ , and thus it is  $\mathcal{X}_{<u}$ -identical to  $\beta'$ . In total, the coloring  $\beta_3$  is  $(G \setminus \mathcal{X}_{\geq u})$ -identical to the coloring  $\beta'$ .

Finally, the coloring  $\beta_3$  is  $\mathcal{X}_{\geq u}$ -identical to the coloring  $\beta_2$  and the vertices  $v$  and  $u$  are both missing the color 3. So in the coloring  $\beta_3$  the fan  $X_v(1)$  is now a path. We invert this path and denote by  $\beta_4$  the coloring obtained after the inversion. The coloring  $\beta_4$  is  $\mathcal{X}_{\geq u}$ -identical to the coloring  $\beta$ , so it is  $\mathcal{X}_{\geq u}$ -identical to the coloring  $\beta'$ . Moreover, the coloring  $\beta_4$  is also  $(G \setminus \mathcal{X}_{\geq u})$ -identical to the coloring  $\beta_3$ , so it is  $(G \setminus \mathcal{X}_{\geq u})$ -identical to the coloring  $\beta'$ . In total the coloring  $\beta_4$  is identical to the coloring  $\beta'$  as desired.  $\square$

**Lemma 2.5.6.** *Let  $\mathcal{V} = (vv_1, \dots, vv_k)$  a cycle of length at least 3 in a coloring  $\beta$ ,  $u = v_i$ ,  $u' = v_{i+1}$  and  $u'' = v_{i-1}$  three consecutive vertices of  $\mathcal{V}$ ,  $\mathcal{Y} = (uy_1, \dots, uy_l)$  a  $(\mathcal{V}, u)$ -independent path,  $\beta_{\mathcal{Y}} = \mathcal{Y}^{-1}(\beta)$ ,  $C$  a  $(\beta(vu), m(u'))$ -bichromatic path in the coloring  $\beta_{\mathcal{Y}}$  between  $u''$  and  $u'$  that does not contain  $v$  nor  $u$ ,  $X = E(C) \cup E(\mathcal{V}) \cup (V(\mathcal{V}) \cup \{v\} \setminus \{u\})$ , and  $\beta'_{\mathcal{Y}}$  a coloring  $X$ -equivalent to  $\beta_{\mathcal{Y}}$ . If there exists a coloring  $\beta'$  equivalent to  $\beta'_{\mathcal{Y}}$  such that:*

- $\beta'$  is  $(G \setminus X)$ -identical to  $\beta'_{\mathcal{Y}}$ ,
- $\beta'$  is  $(\mathcal{V} \setminus \{u', vu'', u, vu\})$ -identical to  $\mathcal{V}^{-1}(\beta)$ ,
- $\beta'(vu'') = \beta'_{\mathcal{Y}}(vu')$ ,
- $\beta'(vu) = m^{\beta'_{\mathcal{Y}}}(u'')$ , and
- $m^{\beta'}(u') = \beta'_{\mathcal{Y}}(vu)$ ,
- for any edge  $e \in C$ :
  - if  $\beta'_{\mathcal{Y}}(e) = \beta(vu)$ , then  $\beta'(e) = m(u')$ , and
  - if  $\beta'_{\mathcal{Y}}(e) = m(u')$ , then  $\beta'(e) = \beta(vu)$ .

Then the cycle  $\mathcal{V}$  is invertible.

## 2. Vizing's edge-coloring conjecture

---

*Proof.* Let  $\gamma = \mathcal{V}^{-1}(\beta)$ . Without loss of generality, we assume that the vertex  $v$  and  $u$  are respectively missing the colors 1 and 2 in the coloring  $\beta$ , and that  $\beta(vu) = 3$ . This means that  $\beta'(vu'') = \beta'_y(vu') = \beta(vu') = m^\beta(u) = 2$  and  $m^{\beta'}(u') = \beta'_y(vu) = \beta(vu) = m^\beta(u'') = 3$ . By definition the coloring  $\beta_y$  is  $(G \setminus (\mathcal{Y} \cup \{u\}))$ -identical to  $\beta$ . Since  $\mathcal{Y}$  is a  $(\mathcal{V}, u)$ -independent path, we have  $E(\mathcal{Y}) \cap E(\mathcal{V}) = \emptyset$ , and  $V(\mathcal{Y}) \cap V(\mathcal{V}) = \emptyset$ . So, in particular  $\beta_y(vu) = \beta(vu) = 3$ . The coloring  $\beta'$  is  $(\{vu\})$ -identical to  $\beta'_y$ , so  $\beta'(vu) = 3$ .

Since the coloring  $\beta'$  is  $(G \setminus X)$ -identical to  $\beta'_y$  and  $\beta'_y$  is  $X$ -equivalent to  $\beta_y$ , by Observation 2.3.7, there exists a coloring  $\beta''$  which is  $X$ -identical to  $\beta'$  and  $(G \setminus X)$ -identical to  $\beta_y$ .

The coloring  $\beta''$  is  $(G \setminus X)$ -identical to  $\beta_y$ , so it is  $(G \setminus (X \cup \mathcal{Y} \cup \{u\}))$ -identical to  $\beta$ . This means that  $\beta''$  is  $(G \setminus (\mathcal{V} \cup \mathcal{Y} \cup C))$ -identical to  $\beta$ , and thus it is  $(G \setminus (\mathcal{V} \cup \mathcal{Y} \cup C))$ -identical to  $\gamma$ . Moreover,  $\beta''$  is  $X$ -identical to  $\beta'$ , and  $\beta'$  is  $(\mathcal{V} \setminus (\{u', vu'', u, vu\}))$ -identical to  $\gamma$ , so  $\beta''$  is  $(\mathcal{V} \setminus (\{u', vu'', u, vu\}))$ -identical to  $\gamma$ . In total, the coloring  $\beta''$  is  $(G \setminus (C \cup \mathcal{Y} \cup \{u', vu'', u, vu\}))$ -identical to  $\gamma$ .

In the coloring  $\beta_y$ , the fan  $X_u(2)$  is now a path, and we have  $E(X_u(2)) = E(\mathcal{Y})$  and  $V(X_u(2)) = V(\mathcal{Y})$ . So in any coloring  $(\mathcal{Y} \cup \{u\})$ -identical to  $\beta_y$ , the fan  $X_u(2)$  is a path. The  $\beta''$  is  $(G \setminus X)$ -identical to  $\beta_y$ ,  $E(X) \cap E(\mathcal{Y}) = \emptyset$  and  $V(X) \cap (V(\mathcal{Y}) \cup \{u\}) = \emptyset$ , so  $\beta''$  is  $(\mathcal{Y} \cup \{u\})$ -identical to  $\beta_y$ , and thus  $X_u^{\beta''}(2)$  is a path that we invert. Let  $\beta_3$  be the coloring obtained after the inversion.

By definition of  $\mathcal{Y}$ , the coloring  $\beta_3$  is  $(\mathcal{Y} \cup \{u\})$ -identical to the coloring  $\beta$ . So it is  $\mathcal{Y}$ -identical to the coloring  $\gamma$ , and  $u$  is now missing the color 2. The coloring  $\beta_3$  is also  $(G \setminus (\mathcal{Y} \cup \{u\}))$ -identical to  $\beta''$ , so it is  $(G \setminus (C \cup \{u', vu'', u, vu\}))$ -identical to  $\gamma$ , and we have  $\beta_3(vu'') = \beta''(vu'') = 2$ ,  $\beta_3(vu) = \beta''(vu) = 3$  and  $m^{\beta_3}(u') = m^{\beta''}(u') = 3$ . Note that the coloring  $\beta_3$  is also  $C$ -identical to the coloring  $\beta''$ .

The path  $C$  is a  $(2, 3)$ -bichromatic path between  $u''$  and  $u'$  and does not contain  $v$  nor  $u$ , so, in the coloring  $\beta_3$ , we have  $K_{u'}(2, 3) = C \cup \{vu'', vu\}$ . We now swap this component and denote by  $\beta_f$  the coloring obtained after the swap. The coloring  $\beta_f$  is  $(G \setminus (C \cup \{u', vu'', u, vu\}))$ -identical to the coloring  $\beta_3$ , so it is  $(G \setminus (C \cup \{u', vu'', u, vu\}))$ -identical to  $\gamma$ . Moreover, since  $\beta_3$  is  $C$ -identical to  $\beta''$ , for any edge  $e \in C$ :

- if  $\beta''(e) = \beta_3(e) = 2$ , then  $\beta_f(e) = 3$ , and
- if  $\beta''(e) = \beta_3(e) = 3$ , then  $\beta_f(e) = 2$ .

So the coloring  $\beta_f$  is  $C$ -identical to the coloring  $\beta_y$ , and thus it is  $C$ -identical to the coloring  $\gamma$ . Finally, we have:

- $m^{\beta_f}(u) = 3 = \beta(vu) = m^\gamma(u)$ ,
- $\beta_f(vu) = 2 = m^\beta(u) = \gamma(vu)$ ,

- $m^{\beta_f}(u') = 2 = \beta(vu') = m^\gamma(u')$ , and
- $\beta_f(vu'') = 3 = m^\beta(u'') = \gamma(vu'')$ .

Finally we have that  $\beta_f$  is  $(C \cup \{u', vu'', u, vu\})$ -identical to  $\gamma$ , so it is identical to  $\gamma$ , and  $\mathcal{V}$  is invertible as desired.  $\square$

**Lemma 2.5.7.** *Let  $\mathcal{V} = (vv_1, \dots, vv_i)$  a minimum cycle in a coloring  $\beta$ ,  $u = v_i$ ,  $u' = v_1$  and  $u'' = v_{i-1}$  three consecutive vertices of  $\mathcal{V}$ , and  $\mathcal{Y} = (uy_1, \dots, uy_i)$  a  $(\mathcal{V}, u)$ -independent path,  $C = K_{u''}(m(u), m(u'')) \setminus \{vu, vu'\}$ , and  $X = C \cup E(\mathcal{V}) \cup (V(\mathcal{V}) \cup \{v\} \setminus \{u\})$ . In any coloring  $\beta'_y$  that is  $X$ -equivalent to the coloring  $\beta_y = \mathcal{Y}^{-1}(\beta)$ , the fan  $X_v(m^\beta(u))$  is not a path.*

*Proof.* Without loss of generality, we assume that the vertices  $v$  and  $u$  are respectively missing the colors 1 and 2, and that  $\beta(vu) = 3$ . This means that  $\beta(vu') = m^\beta(vu) = 2$ ,  $m^\beta(u'') = \beta(vu) = 3$ , and  $m^{\beta_y}(u) = 4$ . Assume that  $\mathcal{X} = X_v^{\beta_y}(2)$  is a path. The vertex  $v$  is still missing the color 1 in the coloring  $\beta_y$  and thus it is still missing 1 in  $\beta'_y$ . The coloring  $\beta_y$  is  $(\mathcal{V} \setminus \{u\})$ -identical to the coloring  $\beta$  and so is the coloring  $\beta'_y$ . So  $\{u', u''\} \subseteq V(\mathcal{X})$  and  $\beta'_y(vu) = \beta(vu)$ , so  $u \in V(\mathcal{X})$ , and thus the size of  $\mathcal{X}$  is at least 3. Note that this means that  $V(\mathcal{V}) = V(\mathcal{X}_{\leq u})$ .

The cycle  $\mathcal{V}$  is a minimum cycle in  $\beta$ , so by Observation 2.3.10, it is tight, and in particular,  $u \in K_{u''}(2, 3)$ . So the  $C$  is a  $(2, 3)$ -bichromatic path between  $u''$  and  $u'$  that does not contain  $u$  nor  $v$ . Since  $\mathcal{Y}$  is a  $(\mathcal{V}, u)$ -independent path, the coloring  $\beta_y$  is  $C$ -identical to  $\beta$ . The coloring  $\beta'_y$  is  $C$ -equivalent to  $\beta_y$  so  $C$  is still the same bichromatic path in the coloring  $\beta'_y$ .

Since  $\mathcal{X}$  is a path of path of length at least 3, by Lemma 2.5.5 there exists a coloring  $\beta'$  such that:

- $\beta'$  is  $(G \setminus (C \cup \mathcal{X}))$ -identical to  $\beta'_y$ ,
- $\beta'$  is  $(\mathcal{X}_{\geq u})$ -identical to  $\beta'_y$ ,
- for any edge  $j \in [2, i - 1]$ ,  $m^{\beta'}(v_j) = \beta'_y(vv_j)$ ,
- $m^{\beta'}(u') = \beta'_y(vu) = 3$ ,
- for any edge  $j \in [1, i - 2]$ ,  $\beta'(vv_j) = m^{\beta_y}(vv_j)$ ,
- $\beta'(vu'') = \beta'_y(vu'') = 2$ ,
- for any edge  $e \in C$ :
  - if  $\beta(e) = \beta'_y(vu) = 3$ , then  $\beta'(e) = m^{\beta_y}(u) = 2$ , and

## 2. Vizing's edge-coloring conjecture

---

- if  $\beta(e) = m^{\beta_{\mathcal{Y}}}(u) = 2$ , then  $\beta'(e) = \beta'_{\mathcal{Y}}(vu) = 3$ .

The coloring  $\beta'$  is  $(G \setminus (C \cup \mathcal{X}))$ -identical to  $\beta'_{\mathcal{Y}}$ , and is  $\mathcal{X}_{\geq u}$ -identical to  $\beta'_{\mathcal{Y}}$ . So the coloring  $\beta'$  is  $(G \setminus X)$ -identical to  $\beta'_{\mathcal{Y}}$ .

Let  $\gamma = \mathcal{V}^{-1}(\beta)$ . For any  $j \in [2, i-2]$ , we have  $\beta'(vv_j) = m^{\beta'_{\mathcal{Y}}}(v_j) = m^{\beta}(v_j) = \gamma(vv_j)$ , and  $m^{\beta'}(v_j) = \beta'_{\mathcal{Y}}(vv_j) = \beta(vv_j) = m^{\gamma}(v_j)$ , so the coloring  $\beta'$  is  $(\mathcal{V} \setminus \{u', vu', u'', vu'', u, vu\})$ -identical to  $\gamma$ . Moreover,  $\beta'(vu) = m^{\beta_{\mathcal{Y}}}(u') = m^{\beta}(u') = \gamma(vu')$  and  $m^{\beta'}(u'') = \beta_{\mathcal{Y}}(vu'') = \beta(vu'') = m^{\gamma}(u'')$ . So in total the coloring  $\beta'$  is  $(\mathcal{V} \setminus \{u', vu'', u, vu\})$ -identical to the coloring  $\gamma$ .

The coloring  $\beta'$  is  $\mathcal{X}_{\geq u}$ -identical to  $\beta'_{\mathcal{Y}}$ , so in particular,  $\beta'(vu) = \beta'_{\mathcal{Y}}(vu) = m^{\beta_{\mathcal{Y}}}(u'')$ . We also have that  $\beta'(vu'') = 2 = \beta'_{\mathcal{Y}}(vu')$ , and  $m^{\beta'}(u') = 3 = \beta'_{\mathcal{Y}}(vu)$ .

Finally, for any edge  $e$  in  $C$ :

- if  $\beta_{\mathcal{Y}}(e) = \beta(e) = 2$ , then  $\beta'(e) = 3$ , and
- if  $\beta_{\mathcal{Y}}(e) = \beta(e) = 3$ , then  $\beta'(e) = 2$ .

So by Lemma 2.5.6, the cycle  $\mathcal{V}$  is invertible; a contradiction.  $\square$

**Lemma 2.5.8.** *Let  $\mathcal{V} = (vv_1, \dots, vv_k)$  be a minimum cycle in a coloring  $\beta$ ,  $u = v_j$ ,  $u' = v_{j+1}$ , and  $u'' = v_{j-1}$  three consecutive vertices of  $\mathcal{V}$  and  $\mathcal{Y}$  a  $(\mathcal{V}, u)$ -independent path. Then in the coloring  $\beta_{\mathcal{Y}} = \mathcal{Y}^{-1}(\beta)$ , the fan  $\mathcal{X} = X_v(m^{\beta}(u)) = (vx_1, \dots, vx_s)$  is a cycle.*

*Proof.* By Lemma 2.5.7, the fan  $\mathcal{X}$  is not a path. To show that it is a cycle, we prove that  $\mathcal{X}$  is not a comet. Otherwise, assume that  $\mathcal{X}$  is a comet, then there exists  $i < s$  such that  $m(x_i) = m(x_s)$ . Without loss of generality, we assume that  $m^{\beta}(v) = 1$ ,  $m^{\beta}(u) = \beta(vu') = 2$ ,  $\beta(vu) = m^{\beta}(u'') = 3$  and  $m^{\beta_{\mathcal{Y}}}(x_i) = m^{\beta_{\mathcal{Y}}}(x_s) = 4$ . We now have to distinguish the cases.

*Case 3* ( $4 \notin \beta(\mathcal{V})$ ).

In the coloring  $\beta$ , the fan  $\mathcal{V}$  is a minimum cycle, so by Observation 2.3.10, it is tight and in particular,  $u \in K_{u''}(2, 3)$ . Let  $C = K_{u''}(2, 3) \setminus \{vu', vu\}$ . The path  $C$  is a  $(2, 3)$ -bichromatic path between  $u''$  and  $u'$  which does not contain  $v$  nor  $u$ . Since  $\mathcal{Y}$  is a  $(\mathcal{V}, u)$ -independent path, the coloring  $\beta_{\mathcal{Y}}$  is  $C$ -identical to  $\beta$ , and thus  $C$  is still a  $(2, 3)$ -bichromatic path between  $u''$  and  $u'$  which does not contain  $u$  nor  $v$ . Let  $X = C \cup E(\mathcal{V}) \cup (V(\mathcal{V}) \cup \{v\} \setminus \{u\})$ . We now consider the components of  $K(1, 4)$  in the coloring  $\beta_{\mathcal{Y}}$ . The vertices  $x_i$  and  $x_s$  are not both part of  $K_v(1, 4)$ . Note that we may have  $x_i = u$ . If  $x_i$  does not belong to  $K_v(1, 4)$ , then we swap the component  $C_{1,4} = K_{x_i}(1, 4)$  to obtain a coloring  $\beta'$   $X$ -equivalent to  $\beta_{\mathcal{Y}}$  where the fan  $X_v(2)$  is now a path. By Lemma 2.5.7; this is a contradiction.

So  $x_i \in K_v(1, 4)$ , and thus  $x_s \notin K_v(1, 4)$ . Similarly to the previous case, we now swap the component  $K_{x_s}(1, 4)$  and obtain a coloring  $X$ -equivalent to  $\beta_{\mathcal{Y}}$  where  $X_v(2)$  is a path. By Lemma 2.5.7 this is again a contradiction.

Case 4 ( $4 \in \beta(\mathcal{V})$ ).

In this case, we have that  $x_i \in V(\mathcal{V})$ . Since  $\mathcal{Y}$  is a  $(\mathcal{V}, u)$ -independent path, it does not contain any vertex missing the color 4 so  $\beta$  is  $\{x_s\}$ -identical to  $\beta_{\mathcal{Y}}$ , and this vertex is still missing the color 4 in the coloring  $\beta$ . Since  $\mathcal{V}$  is a minimum cycle in the coloring  $\beta$ , by Lemma 2.3.4 it is saturated, so  $x_i \in K_v(1, 4)$ , and thus  $x_s \notin K_v(1, 4)$ . We now swap the component  $C_{1,4} = K_{x_s}(1, 4)$ , and denote by  $\beta'$  the coloring obtained after the swap. The fan  $\mathcal{Y}$  was a  $(\mathcal{V}, u)$ -independent path in the coloring  $\beta$ , so the coloring  $\beta'$  is  $\mathcal{Y}$ -equivalent to  $\beta$ , and  $\mathcal{Y}$  is still a  $(\mathcal{V}, u)$ -independent path in this coloring. We now invert  $\mathcal{Y}$  and obtain a coloring  $\beta'_{\mathcal{Y}}$  which is  $(X_v^{\beta_{\mathcal{Y}}}(2) \setminus \{x_s\})$ -equivalent to the coloring  $\beta_{\mathcal{Y}}$ . So now, in the coloring  $\beta'_{\mathcal{Y}}$ , the fan  $X_v(2)$  is a path, by Lemma 2.5.7 this is a contradiction.  $\square$

**Lemma 2.5.9.** *Let  $\mathcal{V} = (vv_1, \dots, vv_k)$  a minimum cycle in a coloring  $\beta$ ,  $u = v_j$  and  $u' = v_{j+1}$  two consecutive vertices of  $\mathcal{V}$ ,  $\mathcal{Y} = (uy_1, \dots, uy_r)$  a  $(\mathcal{V}, u)$ -independent path, and  $x$  the extremity of  $K_{y_r}(m(u), m(v))$  which is not  $y_r$ . Then the fan  $X_v(\beta(uy_1))$  is a comet containing  $x$  which is missing the color  $m(u)$ .*

*Proof.* We assume that  $\mathcal{Y}$  is of minimum size such that  $\mathcal{X} = X_v(\beta(uy_1))$  is not a comet containing  $x$  missing the color  $m(u)$ . Without loss of generality, we assume that  $m(v) = 1$ ,  $m(u) = \beta(vu') = 2$ ,  $\beta(uv) = m^{\beta}(u'') = 3$ , and  $\beta(uy_1) = 4$ .

If  $|\mathcal{Y}| = 1$ , then  $\mathcal{Y}$  consists of a single edge. We swap this edge, and denote by  $\beta'$  the coloring obtained after the swap. In the coloring  $\beta'$ , by Lemma 2.5.8, the fan  $X_v(2)$  is a cycle. In this coloring, the vertex  $u$  is missing the color 4, so  $4 \in \beta'(X_v(2))$ . Let  $\mathcal{X}' = (vx_1, \dots, vx_s)$  be the maximal subfan of  $X_v(2)$  starting with an edge colored 4, and not containing any edge of  $\mathcal{V}$ . Note that  $E(\mathcal{X}') = E(\mathcal{X})$  and  $V(\mathcal{X}') = V(\mathcal{X})$ . Note also that we have  $m^{\beta'}(x_s) = 2$ . The subfan  $\mathcal{X}'$  does not contain any edge of  $\mathcal{V}$ , thus it does not contain the vertex  $u$ , and so it does not contain any vertex missing the color 4. So the coloring  $\beta$  is  $\mathcal{X}$ -equivalent to the coloring  $\beta'$ , and thus in the coloring  $\beta$ , the fan  $X_v(4) = (vx_1, \dots, vx_s, vu', \dots, vu)$  is a comet where  $x_s$  and  $u$  are both missing the color 2. In the coloring  $\beta$ , the cycle  $\mathcal{V}$  is a minimum cycle, so it is saturated by Lemma 2.3.4, and thus  $u \in K_v(1, 2)$  and  $x_s \notin K_v(1, 2)$ . If  $x_s$  is not in  $K_{y_r}(1, 2)$ , then we swap  $C_{1,2} = K_{x_s}(1, 2)$ , to obtain a coloring  $\beta''$  which is  $((\mathcal{X} \cup \mathcal{V} \cup \mathcal{Y}) \setminus \{x_s\})$ -equivalent to  $\beta$ . We now invert the path  $\mathcal{Y}$ , and obtain a coloring where  $X_v(2)$  is a path, by Lemma 2.5.8 this is a contradiction.

So  $|\mathcal{Y}| > 1$ . The size of  $\mathcal{Y}$  is minimum, so for any subpath  $X_u(\beta(uy_j))$  of  $\mathcal{Y}$  with  $j > 1$ , the fan  $X_v(\beta(uy_j))$  is a comet containing  $x$ . So the fan  $X_v(4)$  does not contain any vertex missing a color in  $\beta(\mathcal{Y})$ , otherwise it would be a comet containing  $x$ . Hence the coloring  $\beta_{\mathcal{Y}} = \mathcal{Y}^{-1}(\beta)$  is  $\mathcal{X}$ -equivalent to  $\beta$ . In



the coloring  $\beta_{\mathcal{Y}}$ , the fan  $X_v(2)$  is a cycle by Lemma 2.5.8. Moreover, it contains the fan  $\mathcal{X}$  since  $u$  is missing the color 4 in the coloring  $\beta_{\mathcal{Y}}$ . Therefore, in the coloring  $\beta$ , the fan  $\mathcal{X} = (vx_1, \dots, vx_s, vu', \dots, vu)$  is a comet containing  $\mathcal{V}$  where  $x_s$  and  $u$  are both missing the color 2. Similarly to the previous case, since  $\mathcal{V}$  is a minimum, it is saturated by Lemma 2.3.4, so  $u \in K_v(1, 2)$ , and thus  $x_s \notin K_v(1, 2)$ . If  $x_s \notin K_v(1, 2)$ , then we swap  $C_{1,2} = K_{x_s}(1, 2)$ , and obtain a coloring where  $X_v(4)$  is a path. This coloring is  $\mathcal{Y}$ -equivalent to  $\beta$ , and thus if we invert  $\mathcal{Y}$  we obtain a coloring where  $X_v(2)$  is a path, a contradiction by Lemma 2.5.8.  $\square$

In the following section we prove the property  $P(0)$ .

### 2.5.2 Proof of $P(0)$

In this section we prove the following lemma.

**Lemma 2.5.10.** *The property  $P(0)$  is true.*

To prove that  $P(0)$  is true, we need the following lemma.

**Lemma 2.5.11.** *Let  $\mathcal{V} = (vv_1, \dots, vv_k)$  be a minimum cycle in a coloring  $\beta$ ,  $u = v_j$  and  $u' = v_{j'}$  two vertices of  $\mathcal{V}$ . If  $uu' \in E(G) \cap \mathcal{V}$ , and  $\beta(uu') \neq m(v)$ , then the fan  $\mathcal{X} = X_v(\beta(uu'))$  is a saturated cycle.*

The following lemma is the first step of the proof of Lemma 2.5.11.

**Lemma 2.5.12.** *Let  $\mathcal{V} = (vv_1, \dots, vv_k)$  be a minimum cycle in a coloring  $\beta$ ,  $u = v_j$  and  $u' = v_{j'}$  two vertices of  $\mathcal{V}$ . If  $uu' \in E(G)$  and  $\beta(uu') \neq m(v)$ , then the fan  $\mathcal{X} = X_v(\beta(uu'))$  is not a path.*

*Proof.* Otherwise, assume that  $\mathcal{X}$  is a path. Without loss of generality, we assume that the vertices  $v$ ,  $u$  and  $u'$  are respectively missing the colors 1, 2 and 3. Since  $\beta(uu') \notin \{1, 2, 3\}$ , we also assume that  $\beta(uu') = 4$ . Finally, we assume that  $\mathcal{X}$  is of length one, indeed if the length of  $\mathcal{X}$  is more than one, we invert it until we reach a coloring  $\beta'$   $\mathcal{V}$ -equivalent to  $\beta$  where it has length one without changing the color of  $uu'$ .

We denote by  $x$  the only vertex of  $\mathcal{X}$ , and by  $\beta_2$  the coloring obtained after swapping the edge  $vx$ . The coloring  $\beta_2$  is  $\mathcal{V}$ -equivalent to  $\beta'$ , so  $\mathcal{V}$  is the same minimum cycle in the coloring  $\beta_2$  by Observation 2.3.9. By Lemma 2.3.13, the fans  $\mathcal{U} = X_u^{\beta'}(3) = (uu_1, \dots, uu_l)$  and  $\mathcal{U}' = X_{u'}^{\beta_2}(3)$  are both cycles and  $uu'$  is the last edge of both of these cycles; we denote by  $w$  the vertex missing 4 in  $\mathcal{U}$ . Note that since  $\beta(uu') = 4$ , the vertex  $w$  is the vertex  $u_{l-1}$ , and  $\mathcal{U} = (uu_1, \dots, uw, uu')$ . We first remark that  $4 \notin \beta(\mathcal{V})$ , otherwise the fan  $E(\mathcal{X}) = E(\mathcal{V})$ , and the fan  $\mathcal{X}$  is a cycle and thus is not a path, as desired.

We first prove some basic properties on the fan  $\mathcal{U}$ .

**Proposition 2.5.13.** *The fan  $\mathcal{U}$  contains an edge colored 1, and there is no edge colored with a color in  $\beta(\mathcal{V})$  between the edge colored 1 and the edge colored 4 in  $\mathcal{U}$ .*

*Proof.* We first prove that there is an edge colored 1 in the fan  $\mathcal{U}$ . Assume that  $\mathcal{U}$  does not contain any edge colored 1 in the coloring  $\beta'$ . Since the fan  $\mathcal{U}$  is a cycle, it means that it does not contain any vertex missing the color 1, and in particular it does not contain  $v$ . So the coloring  $\beta_2$  is also  $\mathcal{U}$ -equivalent to the coloring  $\beta'$ . Therefore,  $\mathcal{U} = \mathcal{U}'$  and  $\mathcal{U}'$  contains the vertex  $w$  that is still missing the color 4. The fan  $\mathcal{U}'$  is thus not entangled with  $\mathcal{V}$ , by Lemma 2.3.13 we have a contradiction.

So the fan  $\mathcal{U}$  contains an edge colored 1. Since by Lemma 2.3.13, the fan  $\mathcal{U}$  is a cycle entangled with  $\mathcal{V}$ , it contains the vertex  $v$  which is missing the color 1, and thus it contains the edge  $uv$ , and also the edge  $vv_{j-1}$  (recall that  $vv_{j-1}$  is the edge just before  $vu = vv_j$  in the sequence  $\mathcal{V}$ ). Note that the vertex  $u'$  and  $v_{j-1}$  may be the same vertex.

We now prove that, in the sequence  $\mathcal{U}$ , there is no edge colored with a color in  $\beta(\mathcal{V})$  between the edge colored 1 and the edge colored 4. Assume on the contrary that there exists such an edge  $uu_t$  colored with a color  $c \in \beta(\mathcal{V})$ . Similarly to the previous proof, this means that in the coloring  $\beta_2$ , the fan  $X_u(c)$  is the sequence  $(uu_t, uu_{t+1}, \dots, uw, uu')$  with  $m(w) = m(v) = 4$ . So this fan is not entangled with  $\mathcal{V}$  and by Lemma 2.3.13 we again get a contradiction.  $\square$

Let  $y_1$  be the neighbor of  $u$  connected to  $u$  by the edge colored 1, and  $y_2$  the vertex just after  $y_1$  in the sequence  $\mathcal{U}$ . Note that since  $\beta'(uu') \neq 1$ , the vertex  $y_1$  is different from the vertex  $u'$  but may be equal to the vertex  $w$ . In this case, the vertices  $y_2$  and  $u'$  are the same vertex.

**Proposition 2.5.14.** *The edge  $uy_1$  belongs to the component  $K_v(1, \beta(vu'))$ .*

*Proof.* Assume that  $uy_1$  does not belong to  $K_v(1, \beta(vu'))$ . If the edge  $vu'$  is just after the edge  $vu$  in the fan  $\mathcal{V}$  (i.e. if  $j' = j+1$ ), then it means that  $\beta(vu') = 3$ , and since  $\beta(uy_1) = 1$ , we have that the vertex  $u$  does not belong to the component  $K_v(1, 3)$ . So the fan  $\mathcal{V}$  is not saturated, by Lemma 2.3.4 we have a contradiction. So the edge  $vu'$  is not the edge just after the edge  $vu$  in the fan  $\mathcal{V}$ , and without loss of generality, we assume that  $\beta(vu') = 5$ .

Let  $C_{1,5} = K_{y_1}(1, 5)$ , we first prove that the vertex  $x$  belongs to this component. Since the vertex  $y_1$  is not in  $K_v(1, 5)$ , we have that  $K_v(1, 5) \neq C_{1,5}$ . The fan  $\mathcal{V}$  is a minimum cycle, it is saturated by Lemma 2.3.4, so after swapping  $C_{1,5}$ , we obtain a coloring  $\beta''$   $\mathcal{V}$ -equivalent to  $\beta'$ . By Observation 2.3.9 the cycle  $\mathcal{V}$  is the same minimum cycle in this coloring. In the coloring  $\beta''$  the edge  $uuy_1$  is now colored 5, and the fan  $X_u(5)$  still contains the vertex  $w$  missing the

color 4. Moreover, the vertex  $x$  is still missing the color 1, so we swap the edge  $vu$  to obtain a coloring  $\mathcal{V}$ -equivalent to  $\beta''$  where  $X_u(5)$  contains the vertex  $w$  which is missing the color  $m(v) = 4$ . So  $X_u(5)$  is not entangled with  $\mathcal{V}$ , and by Lemma 2.3.13 we have a contradiction.

Therefore, the vertex  $x$  belongs to the component  $C_{1,5}$ . We first swap the component  $C_{1,5}$  and obtain a coloring  $\beta''$   $\mathcal{V}$ -equivalent to  $\beta'$ . In the coloring  $\beta''$ , the fan  $X_u(5)$  now contains the vertex  $w$  that is still missing 4. So the vertex  $X_v(5)$  contains the vertex  $u'$  and we have  $X_v(5) = X_v(3)$ .

Since the cycle  $\mathcal{V}$  is minimum, by Observation 2.3.10, it is tight. In the coloring  $\beta''$ , the vertex  $x$  is now missing the color 5, we now apply a sequence of Kempe swaps of the form  $K_x(m(v_{t-1}), m(v_t))$  for  $t \in (j' - 1, j' - 2, \dots, j + 1)$  to obtain a coloring  $\beta_3$  where  $m(x) = m(v_{j-1}) = 2$ . Note that each of these swaps is  $\mathcal{V}$ -stable since after each swap the fan  $\mathcal{V}$  is a minimum cycle and thus is tight. Moreover, since no edge of  $\mathcal{U}$  between  $uy_2$  and  $uw$  is colored with a color in  $\beta'(\mathcal{V})$ , the coloring  $\beta_3$  is  $\mathcal{U}_{[y_2, w]}$ -equivalent to  $\beta''$ .

Hence we have  $X_u(\beta_3(uy_1))_{\leq w} = (uy_1, uy_2, \dots, uw)$ . The edge  $uy_1$  may have been recolored during the sequence of swaps, but in the coloring  $\beta_3$ ,  $uy_1$  is guaranteed to be colored with a color in  $\beta_3(\mathcal{V})$ . In the coloring  $\beta_3$ , the vertices  $x$  and  $u$  are missing the same color 2 and the vertex  $v$  is still missing the color 1. the cycle  $\mathcal{V}$  is minimum, so it is saturated by Lemma 2.3.4, and therefore  $x \notin K_v(1, 2)$ .

We swap the component  $C_{1,2} = K_x(1, 2)$  to obtain a coloring where  $v$  and  $x$  are missing the same color 1 and where the edge  $vx$  is colored 4. We now swap the edge  $vx$ , and denote by  $\beta_4$  the coloring obtained after these swaps. The coloring  $\beta_4$  is  $\mathcal{V}$ -equivalent to  $\beta_3$ , and is also  $X_u(\beta_4(uy_1))_{[y_2, w]}$ -equivalent to the coloring  $\beta_3$ . The vertices  $v$  and  $w$  are missing the same color 4, so  $X_u(\beta_4(uy_1))$  and  $\mathcal{V}$  are not entangled in this coloring, and thus by Lemma 2.3.13 we have a contradiction.  $\square$

**Proposition 2.5.15.** *In the coloring  $\beta_2$ , the vertex  $x$  belongs to  $K_x(2, 4)$ .*

*Proof.* Otherwise, assume that it is not the case. In the coloring  $\beta_2$ , the fan  $\mathcal{V}$  is a minimum cycle, so it is saturated by Lemma 2.3.4. Therefore the vertex  $u$  belongs to  $K_v(2, 4)$  and the vertex  $w$  does not belong to this component. By Proposition 2.5.13  $X_u(1)$  contains the vertex  $w$ . We swap the component  $C_{2,4} = K_w(2, 4)$ , and obtain a coloring  $\beta''$   $\mathcal{V}$ -equivalent to  $\beta'$ . By Observation 2.3.9, the cycle  $\mathcal{V}$  is still the same minimum cycle in the coloring  $\beta''$ , and now the vertex  $w$  is missing the color 2. The coloring  $\beta''$  is also  $X_u(1)_{< w}$ -equivalent to the coloring  $\beta'$ , so where  $X_u(1)$  still contains the vertex  $w$ . The vertex  $x$  is still missing the color 4, so we swap the edge  $vu$  to obtain a coloring  $\beta_3$  where  $X_u(1)$  contains the vertex  $w$  missing the color 2, and thus  $X_u(1)$  is a path. By Lemma 2.3.13 we have a contradiction.  $\square$

We are now ready to prove the lemma. We need to distinguish whether or not  $j = j' + 1$ .

*Case 5* ( $j = j' + 1$ ).

In this case, we have  $\beta'(vu) = m^{\beta'}(u') = 3$ . In the coloring  $\beta'$ , the fan  $\mathcal{V}$  is saturated, so  $u' \in K_v(1, 3)$  and thus  $uy_1 \in K_{u'}(1, 3)$ . Let  $C_{1,3} = K_{u'}(1, 3) \setminus \{uy_1, vu\}$ ,  $C_{1,3}$  is a  $(1, 3)$ -bichromatic path between  $u'$  and  $y_1$ . In the coloring  $\beta_2$ , we consider the component  $C_{2,4} = K_w(2, 4)$ ; this component contains the vertex  $x$  by Proposition 2.5.15. After swapping  $C_{2,4}$  we obtain a coloring  $\beta_3$   $\mathcal{V}$ -equivalent to  $\mathcal{V}$  where the fan  $X_u(1)$  is a path. By Observation 2.3.9 the fan  $\mathcal{V}$  is still the same minimum cycle in the coloring  $\beta_3$ . Moreover, the coloring  $\beta_3$  is  $C_{1,3}$ -equivalent to the coloring  $\beta_2$ , and thus  $C_{1,3}$ -equivalent to the coloring  $\beta'$ , so  $C_{1,3}$  is still a  $(1, 3)$ -bichromatic path between  $u'$  and  $y_1$ .

By Proposition 2.5.13 there is no edge in  $E(X_u(1))$  colored with a color in  $\beta_4(\mathcal{V})$ , so we invert  $X_u(1)$  to obtain a coloring  $\beta_5$  that is  $(C_{1,3} \cup (\mathcal{V} \setminus \{u\}))$ -equivalent to  $\beta_4$ . In the coloring  $\beta_4$ , the vertex  $y_1$  is missing the color 1, so  $K_{u'}(1, 3) = C_{1,3}$ , and we swap this component; we denote by  $\beta_5$  the coloring obtained after the swap.

In the coloring  $\beta_5$ , the vertices  $u$  and  $u'$  are both missing the color 1, so we swap the edge  $uu'$  to obtain a coloring where  $u$  and  $u'$  are missing the color 4. In the coloring  $\beta_5$ , the fan  $X_v(2)$  is now a path that we invert to obtain a coloring  $\beta_6$ . In the coloring  $\beta_6$ , the edge  $uw$  is colored 2, and the vertex  $u$  is now missing the color 4, so  $K_u(2, 4) = C_{2,4} \cup \{uw\}$ , and we swap back this component, we denote by  $\beta_7$  the coloring obtained after this swap. Note that since  $|\{1, 2, 3, 4\}| = 4$ , we can swap back  $C_{2,4}$  before  $C_{1,3}$ .

In the coloring  $\beta_7$ , the vertices  $u$  and  $v$  are both missing the color 2, and the edge  $vu$  is colored 3, so we swap the edge  $vu$  to obtain a coloring where  $u$  and  $v$  are both missing the color 4. In the coloring obtained after the swap, the vertices  $u$  and  $y_1$  are both missing the color 3, so the fan  $X_u(4)$  is now a path that we invert. We denote by  $\beta_8$  the coloring obtained after the swap.

In the coloring  $\beta_8$ , the edge  $uu'$  is colored 1, and the edge  $uy_1$  is colored 3, so  $K_u(1, 3) = C_{1,3} \cup \{uu', uy_1\}$  and this component is a  $(1, 3)$ -bichromatic cycle that we swap. In the coloring obtained after the swap, the component  $K_v(3, 4) = \{uu', u'\}$ , and it suffices to swap this component to obtain exactly  $\mathcal{V}^{-1}(\beta')$ . Since  $\mathcal{V}$  is a minimum cycle, this is a contradiction.

So  $j \neq j' + 1$ , and since the role of  $u$  and  $u'$  is symmetric, we also have that  $j' \neq j + 1$ . Therefore, in the cycle  $\mathcal{V}$ , there exists a vertex  $v_{j+1}$  and  $v_{j-1}$  such that  $|\{u, u', v_{j-1}, v_{j+1}\}| = 4$ . Without loss of generality, we assume that  $\beta'(vu') = m^{\beta'}(v_{j-1}) = 5$ , and that  $\beta'(vu) = m^{\beta'}(v_{j+1}) = 6$ .

*Case 6* ( $j \neq j' + 1$ ).

For this case, we need to distinguish the cases based on the shape of

$C_{1,5} = K_{uy_1}(1, 5)$ . Since  $\mathcal{V}$  is saturated in the coloring  $\beta'$ , by Proposition 2.5.14,  $C_{1,5}$  also contains  $v$  and  $v_{j'-1}$ , and therefore this component is a  $(1, 5)$ -path in this coloring. Moreover, the fan  $\mathcal{V}$  is tight by Observation 2.3.10, so  $K_{v_{j-1}}(2, 6)$  contains  $vv_{j+1}$ , and  $vu$ . Let  $C_{2,6} = K_{v_{j-1}}(2, 6) \setminus \{vu, vv_{j+1}\}$ . The path  $C_{2,6}$  is a  $(2, 6)$ -bichromatic path between  $v_{j+1}$  and  $v_{j-1}$ .

There are two cases, in the coloring  $\beta'$ , either  $C_{1,5}$  is such that  $u$  is between  $v_{j'-1}$  and  $y_1$ , or  $y_1$  is between  $v_{j'-1}$  and  $u$ . We start both cases by swapping  $C_{2,4} = K_w(2, 4)$  in the coloring  $\beta_2$ , by Proposition 2.5.15 the vertex  $w$  belongs to this component, and after the swap we have  $m(w) = m(x) = m(u) = 2$ . By Proposition 2.5.13  $X_u(1)$  is a path that we invert to obtain a coloring  $\beta_3 (\{uu'\} \cup (\mathcal{V} \setminus \{u\}))$ -equivalent to  $\beta_2$ .

In the coloring  $\beta_3$ , depending on the shape of  $C_{1,5}$ , either  $u$  is in  $C = K_{v_{j'-1}}(1, 5)$ , or  $y_1$  belongs to this component. We now have to distinguish the cases. Both cases are pretty similar, their proofs rely on the same principle: apply Kempe swaps to reach a coloring where the edges of  $E(\mathcal{V}) \cup \{vw'\}$  induce two fans that are cycles smaller than  $\mathcal{V}$  (and that are invertible since  $\mathcal{V}$  is minimum).

*Subcase 6.1 ( $u$  belongs to  $C$ ).*

In this case,  $C = K_{v_{j'-1}}(1, 5)$  is a  $(1, 5)$ -bichromatic path between  $v_{j'-1}$  and  $u$  and there is a  $(1, 5)$ -bichromatic path  $C'$  between  $y_1$  and  $u'$ .

From the coloring  $\beta_3$ , we swap the component  $C$  to obtain a coloring  $\beta_4$  where the fan  $X_v(5) = (vu', vv_{j'+1}, \dots, vv_{j-1}, vu)$  is a cycle strictly smaller than  $\mathcal{V}$ , so since  $\mathcal{V}$  is minimum, this cycle is invertible. Moreover, the fan  $X_v(1) = (vx, vv_{j+1}, \dots, vv_{j'-1})$  is also a cycle strictly smaller than  $\mathcal{V}$ , and so it is also invertible.

After inverting these two cycles, we obtain a coloring where the component  $K_{v_{j'-1}}(1, 5) = C \cup \{vv_{j'-1}, vu\}$  is  $(1, 5)$ -bichromatic cycle that we swap back; we denote by  $\beta_5$  the coloring obtained after the swap. Now the component  $K_{y_1}(1, 5)$  is exactly  $C'$  and we swap it to obtain a coloring  $\beta_6$ .

In the coloring  $\beta_6$ , the fan  $X_v(3) = (vu', vu, vv_{j-1}, \dots, vv_{j'+1})$  is now a cycle strictly smaller than  $\mathcal{V}$ , so we invert it. In the coloring obtained after this inversion, the  $(2, 6)$ -bichromatic path  $C_{2,6}$  is still a path between  $v_{j+1}$  and  $v_{j-1}$ , but now  $v_{j-1}$  is missing the color 6, and  $v_{j+1}$  is missing the color 2. So  $K_{v_{j+1}}(2, 6) = C_{2,6}$ , and we swap this component. Let  $\beta_7$  be the coloring obtained after the swap.

In the coloring  $\beta_7$ , the fan  $X_v(1) = (vu', vv_{j'+1}, \dots, vv_{j-1}, vx)$  is now a cycle strictly smaller than  $\mathcal{V}$  and we invert it. In the coloring obtained after the inversion,  $K_{y_1}(1, 5)$  is now exactly  $C'$ , and we swap back this component and denote by  $\beta_8$  the coloring obtained after the swap.

In the coloring  $\beta_8$ , the vertices  $y_1$  and  $u$  are both missing the color 1, so the fan  $X_u(2)$  is now a path that we invert to obtain a coloring where  $u$  and  $w$  are

missing the color 2. In the coloring obtained after the inversion, the component  $K_{v_{j+1}}(2, 6)$  is exactly  $C_{2,6} \cup \{vv_{j-1}, vu\}$  and we swap back this component. In the coloring obtained after the swap, the component  $K_w(2, 4)$  is exactly  $C_{2,4}$ , and thus after swapping back this component, we obtain exactly  $\mathcal{V}^{-1}(\beta')$ ; a contradiction.

*Subcase 6.2* ( $y_1$  belongs to  $C$ ).

In this case,  $C = K_{v_{j'-1}}(1, 5)$  is a  $(1, 5)$ -bichromatic path between  $v_{j'-1}$  and  $y_1$  and there is a  $(1, 5)$ -bichromatic path  $C'$  between  $u$  and  $u'$ . From the coloring  $\beta_3$ , we swap the component  $C$  to obtain a coloring where  $X_v(2) = (vv_{j+1}, \dots, vv_{j'-1}, vx)$  is a cycle strictly smaller than  $\mathcal{V}$ , so it is invertible. After inverting it, we obtain a coloring where the component  $K_{v_{j-1}}(2, 6)$  is exactly  $C_{2,6}$ . We swap this component and denote by  $\beta_4$  the coloring obtained after the swap.

In the coloring  $\beta_4$ , the fan  $X_v(1) = (vv_{j'-1}, \dots, vv_{j+1}, vu)$  is now a cycle strictly smaller than  $\mathcal{V}$ , so it is invertible. After inverting it, the component  $K_w(1, 5)$  is now exactly  $C' \cup \{vu', vu\}$  and so it is a  $(1, 5)$ -bichromatic cycle containing  $vu$  and  $vu'$ . After swapping this component, we obtain a coloring where the fan  $X_v(1) = (vu', vv_{j'+1}, \dots, vv_{j-1}, vx)$  is now a cycle strictly smaller than  $\mathcal{V}$ , and we invert it. We denote by  $\beta_5$  the coloring obtained after the inversion.

In the coloring  $\beta_5$ , the component  $K_{v_{j'-1}}(1, 5)$  is exactly  $C$ , and we swap back this component. After the swap we obtain a coloring where the fan  $X_v(5) = (vu, vv_{j+1}, \dots, vv_{j'-1})$  is now a cycle strictly smaller than  $\mathcal{V}$ , and so we invert it and denote by  $\beta_6$  the coloring obtained after the swap.

In the coloring  $\beta_6$ , the component  $K_w(1, 5)$  is now exactly  $C'$  and we swap back this component. After the swap we obtain a coloring where  $u$  and  $y_1$  are both missing the color 1, so the fan  $X_u(2)$  is now a path that we invert. We denote by  $\beta_7$  the coloring obtained after the swap.

In the coloring  $\beta_7$  the component  $K_{v_{j-1}}(2, 6)$  is exactly  $C_{2,6} \cup \{vv_{j-1}, vu\}$  and we swap it back. After the swap of this component, we obtain a coloring where  $K_w(2, 4)$  is exactly  $C_{2,4}$ . After swapping back this component, we obtain exactly  $\mathcal{V}^{-1}(\beta')$ . This is a contradiction. □

From the previous lemma we derive the following corollary.

**Corollary 2.5.16.** *Let  $\mathcal{V} = (vv_1, \dots, vv_k)$  be a minimum cycle in a coloring  $\beta$ ,  $u = v_j$  and  $u' = v_{j'}$  two vertices of  $\mathcal{V}$ . If  $uu' \in E(G)$  and  $\beta(uu') = m(v)$ , then no fan around  $v$  is a path.*

*Proof.* Assume that there exists a fan  $\mathcal{X}$  around  $v$  which is a path. It suffices to swap the last edge  $vx$  of  $\mathcal{X}$  to obtain a coloring  $\beta_2$  ( $\mathcal{V} \cup \{uu'\}$ )-equivalent to

$\beta$  such that  $X_v(\beta_2(uu')) = \{vx\}$  is now a path (of length one). By Observation 2.3.9, the fan  $\mathcal{V}$  is a minimum cycle in the coloring  $\beta_2$ , so by Lemma 2.5.12, we get a contradiction.  $\square$

We are now ready to prove Lemma 2.5.11

*Proof of Lemma 2.5.11.* Without loss of generality, we assume that the vertices  $v$ ,  $u$  and  $u'$  are respectively missing the colors 1, 2 and 3. By Lemma 2.3.13, the fan  $\mathcal{U} = X_u(m(u'))$  is a cycle entangled with  $\mathcal{V}$ , so the edge  $uu'$  is in  $E(G)$ . Assume the  $\beta(uu') \neq 1$ .

We first prove that  $X_v(\beta(uu'))$  is a saturated cycle. If  $\beta(uu') \in \beta(\mathcal{V})$ , then  $X_v(\beta(uu'))$  is exactly the fan  $\mathcal{V}$ . Since  $\mathcal{V}$  is minimum, by Lemma 2.3.4, it is saturated, so  $X_v(\beta(uu'))$  is a saturated cycle as desired.

Hence assume that  $\beta(uu') \notin \beta(\mathcal{V})$ , and without loss of generality, say  $\beta(uu') = 4$ . By Lemma 2.5.12, then fan  $X_v(4)$  is not a path.

We now prove that  $X_v(4)$  is not a comet. Suppose that  $X_v(4) = (vw_1, \dots, vw_t)$  is a comet. So there exists  $i < t$  with  $m(w_i) = m(w_t)$ , we denote by  $c$  this color. If  $c \in \beta(\mathcal{V})$ , the cycle  $\mathcal{V}$  is a subfan of the fan  $X_v(4)$ , and thus  $w_t = M(\mathcal{V}, c) \in V(\mathcal{V})$  and  $w_i \notin V(\mathcal{V})$ . Since  $\mathcal{V}$  is minimum, it is saturated by Lemma 2.3.4, so  $w_t \in K_v(1, c)$ , and thus  $w_i \notin K_v(1, c)$ . We now swap the component  $K_{w_i}(1, c)$  and obtain a coloring  $\beta_2$  ( $\mathcal{V} \cup \{uu'\}$ )-equivalent to  $\beta$ , so the cycle  $\mathcal{V}$  is also a minimum cycle in the coloring  $\beta_2$  by Observation 2.3.9. In the coloring  $\beta_2$ , the fan  $X_v(\beta_2(uu')) = X_v(4)$  is a now path, by Lemma 2.5.12 this is a contradiction.

So  $c \notin \beta(\mathcal{V})$ . The vertices  $w_i$  and  $w_t$  are not both part of  $K_v(1, c)$ . If  $w_i$  is not in  $K_v(1, c)$ , we swap  $K_{w_i}(1, c)$  and obtain a coloring  $\beta_2$ , ( $\mathcal{V} \cup \{uu'\}$ )-equivalent to  $\beta$ . So the coloring  $\beta_2$ , by Observation 2.3.9, the fan  $\mathcal{V}$  is a minimum cycle. But the fan  $X_v(4) = X_v(\beta_2(uu'))$  is now a path, a contradiction by Lemma 2.5.12.

So the vertex  $w_i$  belongs to the component  $K_v(1, c)$  and thus  $w_t$  does not belong to this component. We now swap  $K_{w_t}(1, c)$  and obtain a coloring  $\beta_2$  which is ( $\mathcal{V} \cup \{uu'\}$ )-equivalent to  $\beta$ . So by Observation 2.3.9, the fan  $\mathcal{V}$  is still the same minimum cycle in  $\beta_2$ , but the fan  $X_v(4) = X_v(\beta_2(uu'))$  is now a path, again a contradiction by Lemma 2.5.12.

Therefore the fan  $X_v(4)$  is a cycle. We now prove that is it saturated. Note that since  $X_v(4)$  is a cycle,  $\beta(X_v(4)) \cap \beta(\mathcal{V}) = \{1\}$ . Assume that  $X_v(4) = (vw_1, \dots, vw_t)$  is not saturated, so there exists  $i$  such that  $w_i \notin K_v(1, m(w_i))$ . We now have to distinguish whether  $w_i = w_t$  or not.

*Case 7 ( $w_i \neq w_t$ ).*

This case is similar to the case where  $X_v(4)$  is a comet. In this case, the vertex  $w_i$  is missing a color which is not in  $\{1, 2, 3, 4\}$ , and we can assume without loss of generality that  $m(w_i) = 5$ . Since  $w_i$  does not belong to  $K_v(1, 5)$ , we swap the component  $K_{w_i}(1, 5)$  to obtain a coloring  $\beta_2$  ( $\mathcal{V} \cup \{uu'\}$ )-equivalent to  $\beta$ . In the

coloring  $\beta_2$ , by Observation 2.3.9, the fan  $\mathcal{V}$  is the same minimum cycle, but the fan  $X_v(4) = (w_1, \dots, w_i)$  is now a path, a contradiction by Lemma 2.5.12.

*Case 8* ( $w_i = w_t$ ).

In this case,  $w_t$  does not belong to  $K_v(1, 4)$ . We first swap the component  $C_{1,4} = K_{w_t}(1, 4)$ . If  $uu' \notin C_{1,4}$ , then we obtain a coloring  $\beta_2 (\mathcal{V} \cup \{uu'\})$  equivalent to  $\beta$ . So by Observation 2.3.9, the fan  $\mathcal{V}$  is a minimum cycle in the coloring  $\beta_2$ , but now the fan  $X_v(4) = X_v(\beta_2(uu')) = (vw_1, \dots, vw_t)$  is now a path; a contradiction by Lemma 2.5.12.

So the edge  $uu'$  is in  $C_{1,4}$ . After swapping  $C_{1,4}$ , we obtain a coloring  $\beta_2 (\mathcal{V})$ -equivalent to  $\beta$ , so  $\mathcal{V}$  is still a minimum cycle. But now  $\beta_2(uu') = 1$ , and  $X_v(4)$  is a path, so by Corollary 2.5.16, we have a contradiction.

Hence  $X_v(4)$  is a saturated cycle as desired. □

The proof of  $P(0)$  is a direct consequence of the two previous lemmas.

*Proof of Lemma 2.5.10.* Let  $\mathcal{V}$  be a minimum cycle around a vertex  $v$  in a coloring  $\beta$ ,  $u$  and  $u'$  two vertices of  $\mathcal{V}$ ,  $\mathcal{U} = X_u(m(u')) = (uu_1, \dots, uu_l)$ , assume that  $\beta(uu') \neq m(v)$  and let  $\mathcal{W} = X_v(\beta(uu_l)) = (vw_1, \dots, vw_s)$ . Without loss of generality, we assume that the vertices  $v$ ,  $u$  and  $u'$  are respectively missing the colors 1, 2, and 3, and that the edge  $uu'$  is colored 4.

We first prove that  $\mathcal{W}$  is a saturated cycle containing  $u_{l-1}$ . By Lemma 2.5.11, the fan  $\mathcal{W}$  is a saturated cycle, and thus  $w_s$  is missing the color 4. We now prove that the fan  $\mathcal{W}$  contains the vertex  $u_{l-1}$ .

If  $4 \in \beta(\mathcal{V})$ , then  $\mathcal{W} = \mathcal{V}$ , and since  $\mathcal{U}$  is entangled with  $\mathcal{V}$  by Lemma 2.3.13, we have that  $u_{l-1} = w_s \in \mathcal{V} = \mathcal{W}$ . So the color 4 is not in  $\beta(\mathcal{V})$ .

Assume that the fan  $\mathcal{W}$  does not contain  $u_{l-1}$ , so in particular,  $u_{l-1} \neq w_s$ . The cycle  $\mathcal{W}$  is saturated, so  $w_s \in K_v(1, 4)$ , and thus  $u_{l-1} \notin K_v(1, 4)$ . By Lemma 2.5.19

- $u \in K_{u_{l-1}}(1, 4)$ ,
- there exists  $j \leq l - 1$  such that  $\beta(uu_j) = 1$ , and
- the subfan  $(uu_{j+1}, \dots, uu_{l-1})$  is a  $(\mathcal{V}, u)$ -independent subfan.

We now consider the coloring  $\beta'$  obtained from  $\beta$  after swapping the component  $C_{1,4} = K_{u_{l-1}}(1, 4)$ . Let  $\mathcal{X} = (uu_{j+1}, \dots, uu_{l-1})$ . The coloring  $\beta'$  is  $(\mathcal{V} \cup \mathcal{W} \cup (\mathcal{X} \setminus \{u_{l-1}\}))$ -equivalent to  $\beta$ , so  $\mathcal{V}$  is a minimum by Observation 2.3.9, and  $\mathcal{W} = X_v(4)$  is still a cycle. The vertex  $v$  is still missing the color 1, but now the vertex  $u_{l-1}$  is missing the color 1, the edge  $uu_j$  is colored 4, and the edge  $uu_l$  is colored 1. So now  $X_u(4) = \mathcal{X}' = (uu_j, \dots, uu_l)$  is a  $(\mathcal{V}, u)$ -independent



subfan avoiding the vertex  $v$ . By Lemma 2.5.4 the fan  $X_v(4)$  is a path; a contradiction.  $\square$

We now prove some properties of the fans around a vertex of a minimum cycle.

### 2.5.3 Fans around the vertices of a minimum cycle

We first prove that some fans around a vertex of a minimum cycle are not paths.

**Proposition 2.5.17.** *Let  $\mathcal{V} = (v_1, \dots, v_k)$  be a minimum cycle in a coloring  $\beta$ ,  $u = v_j$  and  $u' = v_{j'}$  two vertices of  $\mathcal{V}$ , and  $\mathcal{U} = X_u(m(u')) = (uu_1, \dots, uu_l)$ , and  $w = u_s$  a vertex of  $\mathcal{U}$ . Then for any color  $c \in \beta(\mathcal{V})$ , the fan  $\mathcal{W} = X_w(c) = (ww_1, \dots, ww_t)$  is not a path.*

*Proof.* Otherwise assume that the fan  $\mathcal{W}$  is a path. The vertex  $w$  is not a vertex of  $V(\mathcal{V})$ , otherwise since  $\mathcal{W}$  is a path, by Lemma 2.3.13 we have a contradiction. So the vertex  $w$  is not in  $V(\mathcal{V})$ .

We invert it until we reach a coloring  $\beta_2$  where  $m^{\beta_2}(w) \in \beta(\mathcal{V} \cup \mathcal{U}_{<s})$ , we denote by  $c'$  this new missing color. Since  $c \in \beta(\mathcal{W})$ , the color  $c'$  is well defined. The coloring  $\beta_2$  is  $(\mathcal{V} \cup \mathcal{U}_{<s})$ -equivalent to  $\beta$ . Thus by Observation 2.3.9, the sequence  $\mathcal{V}$  is still a minimum cycle in the coloring  $\beta_2$ . Let  $\mathcal{U}' = X_u(m^{\beta_2}(u')) = (uu'_1, \dots, uu'_l)$ . Since  $\beta_2$  is  $(\mathcal{U}_{<s})$ -equivalent to  $\beta$ , we have that  $\mathcal{U}_{<s} = \mathcal{U}'_{<s}$ , so the edge  $uw$  is also in  $E(\mathcal{U}')$ , it is exactly the edge  $uu'_s$ . If  $c' \in \beta(\mathcal{V})$ , then  $\mathcal{U}'$  is not entangled with  $\mathcal{V}$  in the coloring  $\beta_2$ , a contradiction by Lemma 2.3.13. If  $c' \in \beta\mathcal{U}_{<s}$ , then  $\mathcal{U}'$  is now a comet in the coloring  $\beta_2$ , again, by Lemma 2.3.13 we have a contradiction.  $\square$

**Lemma 2.5.18.** *Let  $i \geq 0$ ,  $\mathcal{V}$  be a minimum cycle in a coloring  $\beta$ ,  $u$  and  $u'$  two vertices of  $\mathcal{V}$ ,  $\mathcal{U} = X_u(m(u')) = (uu_1, \dots, uu_l)$ , and  $c \in \beta(\mathcal{V}) \cup \beta(\mathcal{U}_{<u_i})$ . If  $u_i \notin V(\mathcal{V}) \cup \{v\}$ . Then the fan  $\mathcal{X} = X_{u_i}(c) = (u_ix_1, \dots, u_ix_s)$  is not a path.*

*Proof.* Assume  $u_i \notin V(\mathcal{V})$  and that  $\mathcal{X}$  is a path. Without loss of generality, we assume that there is no edge in  $\mathcal{X}_{[x_2, x_s]}$  colored with a color in  $\beta(\mathcal{V}) \cup \beta(\mathcal{U}_{<u_i})$ , otherwise, it suffices to consider the subfan of  $\mathcal{X}$  starting with this edge, this fan is also a path. We now invert  $\mathcal{X}$  and obtain a coloring  $\beta'$  where  $m(u_i) = c$ . The coloring  $\beta'$  is  $(\mathcal{V} \cup \mathcal{U}_{<u_i})$ -equivalent to  $\beta$ . So by Observation 2.3.9, the fan  $\mathcal{V}$  is a minimum cycle in the coloring  $\beta'$ . If  $c \in \beta(\mathcal{V})$ , now the fan  $X_u(m(u'))$  contains the vertex  $u_i$  which is missing the color  $c \in \beta(\mathcal{V})$ , so  $X_u(m(u'))$  is not entangled with  $\mathcal{V}$ . If  $m(u_i) \in \beta(\mathcal{U}_{<u_i})$ , let  $u'' = M(\mathcal{U}_{<u_i}, c)$ . Then  $X_u(m(u'))$  is now a comet since it contains the vertices  $u_i$  and  $u''$  both missing the color  $c$ . In both cases, by Lemma 2.3.13 we have a contradiction.  $\square$

We now prove a sufficient condition for a fan around a vertex of a minimum to contain an edge colored with the color missing at the central vertex of the minimum cycle.

**Lemma 2.5.19.** *Let  $\mathcal{V}$  be a minimum cycle in a coloring  $\beta$ ,  $u$  and  $u'$  two vertices of  $\mathcal{V}$ ,  $\mathcal{U} = X_u(m(u')) = (uu_1, \dots, uu_l)$  and  $i \leq l$ . If  $\beta(uu_i) \neq m(v)$ ,  $m(u_i) \notin \beta(\mathcal{V})$  and  $u_i \notin K_v(m(v), m(u_i))$ , then:*

- $u \in K_{u_i}(m(v), m(u_i))$ ,
- there exists  $j < i$  such that  $\beta(uu_j) = m(v)$ , and
- the subfan  $(uu_{j+1}, \dots, uu_i)$  is a  $(\mathcal{V}, u)$ -independent subfan.

*Proof.* Without loss of generality, we assume that the vertices  $v$ ,  $u$ , and  $u'$  are respectively missing the colors 1, 2 and 3. Assume that  $u_i \notin K_v(1, m(u_i))$ . Since the cycle  $\mathcal{V}$  is minimum, by Lemma 2.3.4 it is saturated, so for any  $u'' \in V(\mathcal{V})$ ,  $u'' \in K_v(m(v), m(u''))$ , thus  $u_i \notin V(\mathcal{V})$ , so without loss of generality, we may assume that  $u_i$  is missing the color 4. We first consider the component  $C_{1,4} = K_{u_i}(1, 4)$ . In the coloring  $\beta$ , by Lemma 2.3.13,  $\mathcal{U}$  is a cycle entangled with  $\mathcal{V}$ , so it does not contain any other vertex missing 4. Since  $v \notin C_{1,4}$ , then  $V(C_{1,4}) \cap V(\mathcal{U}) = \{u_i\}$ . After swapping  $C_{1,4}$ , we obtain a coloring  $\beta'$  ( $V(\mathcal{U}) \setminus \{u_i\}$ )-identical to  $\beta$  where  $u_i$  is now missing the color 1. Note that the coloring  $\beta'$  is also  $\mathcal{V}$ -equivalent to  $\beta$ , and thus  $\mathcal{V}$  is still a minimum cycle in  $\beta'$ . Moreover the vertex  $v$  is still missing the color 1 in  $\beta'$ .

We first prove that the vertex  $u$  belongs to  $C_{1,4}$  and that there is an edge colored 1 in  $\{uu_1, \dots, uu_{i-1}\}$ . If  $u \notin C_{1,4}$ , or if there is no edge colored 1 in  $\{uu_1, \dots, uu_{i-1}\}$ , then the coloring  $\beta'$  is also ( $E(\mathcal{U}_{[uu_1, uu_i]})$ )-identical to  $\beta$ , and so  $X_u(3)$  now contains the vertex  $u_i$  which is missing the color 1, so  $X_u(3)$  is not a cycle entangled with  $\mathcal{V}$ . Since the cycle  $\mathcal{V}$  is minimum, we have a contradiction by Lemma 2.3.13. So  $u \in C_{1,4}$  and there is an edge  $uu_j$  with  $j < i$  colored 1.

We now prove that  $(uu_{j+1}, \dots, uu_i)$  is a  $(\mathcal{V}, u)$ -independent subfan. Note that we have  $j + 1 = i$  (i.e. the subfan is of length 1). Since  $\beta'$  is ( $V(\mathcal{U}) \setminus \{u_i\}$ )-identical to  $\beta$ , the sequence  $(uu_{j+1}, \dots, uu_i)$  is a subfan. Assume that there exists  $s \in \{j + 1, \dots, i\}$  such that  $\beta(uu_s) \in \beta(\mathcal{V})$ . Then, in the coloring  $\beta'$ ,  $X_u(\beta(uu_s))$  contains the vertex  $u_i$  that is missing the color 1, thus it is not a cycle entangled with  $\mathcal{V}$ , by Lemma 2.3.13, this is a contradiction.  $\square$

**Lemma 2.5.20.** *Let  $\mathcal{V}$  be a minimum cycle in a coloring  $\beta$ ,  $u$  and  $u'$  two vertices of  $\mathcal{V}$ ,  $\mathcal{U} = X_u(m(u')) = (uu_1, \dots, uu_l)$  and  $i \leq l$  such that  $m(u_i) \notin \beta(\mathcal{V})$ . Let  $\beta'$  be a coloring obtained from  $\beta$  by swapping a  $(m(v), c)$ -component  $C$  that does not contain  $v$  for some color  $c \notin (\beta(\mathcal{U}_{<u_i}) \cup \{m(v)\})$ . If there exists a coloring  $\beta''$  such that:*

## 2. Vizing's edge-coloring conjecture

---

- $\beta''$  is  $(\mathcal{V} \cup \mathcal{U}_{<u_i})$ -equivalent to  $\beta'$ , and
- $m^{\beta''}(u_i) \in \beta''(\mathcal{V}) \cup \beta''(\mathcal{U}_{<u_i})$ .

Then

- $u \in C$ ,
- there exists  $j < i$  such that  $\beta(uu_j) = m(v)$ , and
- the subfan  $(uu_{j+1}, \dots, uu_i)$  is a  $(\mathcal{V}, u)$ -independent subfan in  $\beta$ .

*Proof.* Without loss of generality, we assume that the vertices  $v$ ,  $u$ , and  $u'$  are respectively missing the colors 1, 2 and 3. Assume that there exists such a coloring  $\beta''$ . Note that since  $m(u_i) \notin \beta(\mathcal{V})$ , the vertex  $u_i$  is not in  $\mathcal{V}$ . The cycle  $\mathcal{V}$  is a minimum cycle in  $\beta$ , so it is saturated by Lemma 2.3.4. Therefore, if  $c \in \beta(\mathcal{V})$ , then  $M(\mathcal{V}, c) \in K_v(1, c)$ , and thus  $M(\mathcal{V}, c) \notin C$ . So  $\beta'$  is  $V(\mathcal{V})$ -equivalent to  $\beta$ . Moreover,  $v \notin C$  so  $\beta'$  is also  $(E(\mathcal{V}) \cup \{v\})$ -equivalent to  $\beta$ . Therefore, the coloring  $\beta'$  is  $(\mathcal{V} \cup \{v\})$ -equivalent to  $\beta$ .

We first prove that the vertex  $u$  belongs to  $C$  and that there exists an edge colored 1 in  $\mathcal{U}_{<u_i}$ . Assume that  $u$  does not belong to  $C$ , or that there is no edge colored 1 in  $\mathcal{U}_{<u_i}$  in  $\beta$ . We show that  $\beta''$  is  $(\mathcal{V} \cup \mathcal{U}_{<u_i})$ -equivalent to  $\beta$ . To prove it, it suffices to prove that  $\beta'$  is  $\mathcal{U}_{<u_i}$ -equivalent to  $\beta$ . The swap between  $\beta$  and  $\beta'$  only changes the colors of edges colored 1 or  $c$ . Since  $\{1, c\} \cap \beta(\mathcal{U}_{<u_i}) = \emptyset$  this means that the coloring  $\beta'$  is  $\mathcal{U}_{<u_i}$ -equivalent to  $\beta$ . Since  $\beta'$  is also  $(\mathcal{V} \cup \{v\})$ -equivalent to  $\beta$ , in total it is  $(\mathcal{V} \cup \mathcal{U}_{<u_i})$ -equivalent to  $\beta$ . Note that the missing color of  $v$  may be different in  $\beta'$  and  $\beta''$ . Since  $\beta''$  is  $(\mathcal{V} \cup \mathcal{U}_{<u_i})$ -equivalent to  $\beta'$ , the coloring  $\beta''$  is  $(\mathcal{V} \cup \mathcal{U}_{<u_i})$ -equivalent to  $\beta$ . Note that the missing color of  $v$  may be different in  $\beta'$  and  $\beta''$ . Hence, in the coloring  $\beta''$ , by Observation 2.3.9, the cycle  $\mathcal{V}$  is a minimum cycle and we have that  $X_u(m(u'))$  now contains the vertex  $u_i$  which is missing a color in  $(\beta''(\mathcal{V}) \cup \beta''(\mathcal{U}_{<u_i}))$ . Let  $c'$  be this color. Since the cycle  $\mathcal{V}$  is minimum in  $\beta''$ , by Lemma 2.3.13,  $X_u(m(u'))$  is a cycle entangled with  $\mathcal{V}$ . If  $c' \in \beta''(\mathcal{V})$ , then  $X_u(m(u'))$  is not entangled with  $\mathcal{V}$ , and if  $c' \in \beta''(\mathcal{U}_{<u_i})$  then  $X_u(m(u'))$  is a comet. In both cases, we have a contradiction. So  $u \in C$ , and there exists  $j < i$  such that  $\beta(uu_j) = 1$ .

We now prove that the subfan  $\mathcal{X} = (uu_{j+1}, \dots, uu_i)$  is a  $(\mathcal{V}, u)$ -independent subfan in  $\beta$ . Note that we have  $j + 1 = i$  (i.e. the subfan is of length 1). If  $\mathcal{X}$  is not a  $(\mathcal{V}, u)$ -independent subfan, then there exists  $s \in \{j + 1, \dots, i\}$  such that  $c' \in \beta(uu_s) \in \beta(\mathcal{V})$ . Recall that the coloring  $\beta'$  is  $(\mathcal{V} \cup \{v\})$ -equivalent to  $\beta$ , and thus that  $\beta''$  is also  $(\mathcal{V} \cup \{v\})$ -equivalent to  $\beta$ . In the coloring  $\beta'$ , the edge  $uu_j$  is now colored  $c$ , and this is the only edge in  $E(\mathcal{U}_{<u_i})$  that has been recolored during the swap of  $C$ . Moreover, the cycle  $\mathcal{V}$  is minimum in  $\beta$ , and thus by Lemma 2.3.13, then fan  $\mathcal{U}$  is a cycle, and does not contain any vertex

missing the color 1 in  $V(\mathcal{U}[u_j, u_i])$ . Since  $c \notin \beta(\mathcal{U}_{<u_i})$ , the coloring  $\beta'$  is also  $V(\mathcal{U}[u_j, u_i])$ -equivalent to the coloring  $\beta$ , and so it is  $\mathcal{X}$ -equivalent to  $\beta$ . The coloring  $\beta''$  is  $\mathcal{U}_{<u_i}$ -equivalent to  $\beta'$ , so it is  $(\mathcal{X} \setminus \{u_i\})$ -equivalent to  $\beta$  and thus the fan  $X_u(c')$  now starts with the edge  $uu_s$  and contains the vertex  $u_i \notin V(\mathcal{V})$  which is missing a color in  $\beta(\mathcal{V}) = \beta''(\mathcal{V})$ . Since  $\mathcal{V}$  is also a minimum cycle in  $\beta''$ , by Lemma 2.3.13,  $X_v(c')$  is a cycle entangled with  $\mathcal{V}$ ; this is a contradiction.  $\square$

In the following section we prove some properties that are guaranteed if the property  $P$  is true up to some  $i$ .

### 2.5.4 Properties guaranteed by $P(i)$

The following lemma guarantees that the last vertices of two cycles will be the same.

**Lemma 2.5.21.** *Let  $i \geq 0$ ,  $\mathcal{V}$  be a minimum cycle around a vertex  $v$  in a coloring  $\beta$ ,  $u$  and  $u''$  two vertices of  $\mathcal{V}$ ,  $\mathcal{U} = X_u^\beta(m^\beta(u'')) = (uu_1, \dots, uu_i)$ ,  $\beta'$  a coloring  $(\mathcal{V} \cup \mathcal{U}_{[u_{l-(i-1)}, u_l]} \cup \bigcup_{j \in [0, i-1]} X_v(\beta(uu_{l-j}))$ -equivalent to  $\beta$  and  $\mathcal{U}' = X_u^{\beta'}(m^{\beta'}(u'')) = (uu'_1, \dots, uu'_s)$ . If*

- for any  $j < i$   $P(j)$  is true, and
- $\{m^\beta(v), m^{\beta'}(v)\} \cap \beta(\mathcal{U}_{[u_{l-(i-1)}, u_l]}) = \emptyset$

then for any  $t \leq i$ ,  $u_{l-t} = u'_{s-t}$ .

*Proof.* Assume that  $P(j)$  is true for all  $j < i$ , that  $\{m^\beta(v), m^{\beta'}(v)\} \cap \beta(\mathcal{U}_{[u_{l-(i-1)}, u_l]}) = \emptyset$  and that there exists  $t \leq i$  such that  $u_{l-t} \neq u_{s-t}$ , without loss of generality, we may assume that such a  $t$  is minimum. The cycle  $\mathcal{V}$  is a minimum cycle in  $\beta$ , and  $\beta'$  is  $\mathcal{V}$ -equivalent to  $\beta$ , so by Observation 2.3.9, the cycle  $\mathcal{V}$  is also a minimum cycle in the coloring  $\beta'$ . Therefore by Lemma 2.3.13, the fans  $\mathcal{U}$  and  $\mathcal{U}'$  are both cycles entangled with  $\mathcal{V}$  respectively in  $\beta$  and  $\beta'$ . Note that since  $m^\beta(v) \notin \beta(\mathcal{U}_{[u_{l-(i-1)}, u_l]})$ , and that  $P(j)$  is true for all  $j < i$ , for all  $j < i$ , the fan  $X_v(\beta(uu_{l-j}))$  is a cycle containing  $u_{l-j-1}$ . Moreover, this also means that no vertex in  $V(\mathcal{U}_{[u_{l-i}, u_l]})$  is missing the color  $m(v)$ , and thus none of them is  $v$ . Therefore the vertex  $v$  may be missing a different color in  $\beta$  and in  $\beta'$ . Note also that, in the coloring  $\beta$ , the edge  $uu_{l-i}$  may be colored  $m^\beta(v)$  or  $m^{\beta'}(v)$ .

We first show that  $t \neq 0$ . Since the fans  $\mathcal{U}$  and  $\mathcal{U}'$  are both cycles we have  $m^\beta(u_l) = m^{\beta'}(u_s) = m^\beta(u'')$ , and moreover,  $\mathcal{U}$  and  $\mathcal{U}'$  are entangled with  $\mathcal{V}$  so  $u_l = u'' = u'_s$ , and thus  $t \neq 0$ .

Since  $t$  is minimum,  $u_{l-(t-1)} = u'_{s-(t-1)}$ . Moreover,  $\beta'$  is  $\mathcal{U}_{[u_{l-(i-1)}, u_l]}$ -equivalent to  $\beta$ , so in particular  $\beta(uu_{l-(t-1)}) = \beta'(uu_{l-(t-1)}) = \beta'(uu'_{s-(t-1)})$ , without

## 2. Vizing's edge-coloring conjecture

---

loss of generality, we assume that this color is 1. This means that both the vertices  $u_{l-t}$  and  $u'_{s-t}$  are missing the color 1. To reach a contradiction we show that both these vertices belong to a same cycle. Since  $1 \neq m^\beta(v)$  and  $P(t-1)$  is true, then  $X^\beta(1)$  is a cycle containing  $u_{l-t}$ . Similarly  $1 \neq m^{\beta'}(v)$  and  $P(t-1)$  is true so  $X_v^{\beta'}(1)$  is a cycle containing  $u'_{s-t}$ . However, the coloring  $\beta'$  is  $(\bigcup_{j \in [0, i-1]} X_v(\beta(uu_{l-j})))$ -equivalent to the coloring  $\beta$ , so in particular  $X_v^\beta(1) = X_v^{\beta'}(1)$ ; we denote by  $\mathcal{X}$  this fan. The fan  $\mathcal{X}$  is a cycle and contains two vertices  $u_{l-t}$  and  $u_{s-t}$  that are both missing the color 1, this is a contradiction.  $\square$

Now we prove that we can guarantee that there is no path around the central vertex of a minimum cycle

**Lemma 2.5.22.** *Let  $i \geq 0$ ,  $\mathcal{V}$  be a minimum cycle around a vertex  $v$  in a coloring  $\beta$ ,  $u$  and  $u''$  two vertices of  $\mathcal{V}$ ,  $\mathcal{U} = X_u^\beta(m(u'')) = (uu_1, \dots, uu_l)$ , and  $\mathcal{X} = (vx_1, \dots, vx_s)$  a fan around  $v$ . If*

- for any  $j < i$   $P(j)$  is true,
- $P_{weak}(i)$  is true, and
- $\beta(uu_{l-i}) = m(v)$ ,

then  $\mathcal{X}$  is not a path.

*Proof.* Without loss of generality we assume that  $m(v) = 1$ . Assume that for any  $j < i$   $P(j)$  is true, that  $P_{weak}(i)$  is true, that  $\beta(uu_{l-i}) = m(v)$  and that  $\mathcal{X}$  is a path. The fan  $\mathcal{X}$  is a path so the vertex  $x_s$  is also missing the color 1, without loss of generality, we assume that  $\beta(vx_s) = 2$ . Note that this means that  $X_v(2)$  is also a path (of length 1). The cycle  $\mathcal{V}$  is minimum and by Lemma 2.3.13 the fan  $\mathcal{U}$  is a cycle entangled with  $\mathcal{V}$ . Since  $\beta(uu_{l-i}) = 1$ , no edge in  $E(\mathcal{U}_{[u_{l-(i-1)}, u_l]})$  is colored 1. Since  $P(j)$  is true for all  $j < i$ ,  $X_v(\beta(uu_{l-j}))$  is a cycle for all  $j < i$ ; since  $X_v(2)$  is a path, no edge in  $E(\mathcal{U}_{[u_{l-(i-1)}, u_l]})$  is colored 2 either.

We now consider the coloring  $\beta'$  obtained from  $\beta$  by swapping the edge  $vx_s$ . Note that in the coloring  $\beta'$ , the vertex  $v$  is now missing the color 2, and the fan  $X_v^{\beta'}(1)$  is now a path (of length 1). The coloring  $\beta'$  is clearly  $\mathcal{V}$ -equivalent to  $\beta$  so by Observation 2.3.9, the fan  $\mathcal{V}$  is a minimum cycle in the coloring  $\beta'$ . Let  $\mathcal{U}' = X_u^{\beta'}(m(u'')) = (uu'_1, \dots, uu'_s)$ . No edge in  $E(\mathcal{U}_{[u_{l-(i-1)}, u_l]})$  is colored 1, so no vertex in  $V(\mathcal{U}_{[u_{l-i}, u_l]})$  is missing the color 1, and thus  $\beta'$  is also  $\mathcal{U}_{[u_{l-(i-1)}, u_l]}$ -equivalent to  $\beta$ . Finally since no edge in  $E(\mathcal{U}_{[u_{l-(i-1)}, u_l]})$  is colored 1 and  $P(j)$  is true for all  $j < i$ , the fans  $X_v(\beta(uu_{l-j}))$  are cycles for all  $j < i$ . Therefore the coloring  $\beta'$  is also  $(\bigcup_{j \in [0, i-1]} X_v(\beta(uu_{l-j})))$ -equivalent to  $\beta$ . By Lemma 2.5.21,

for any  $t \leq i$   $u_{l-t} = u'_{s-t}$ , so in particular  $u_{l-i} = u'_{s-i}$ . In the coloring  $\beta'$  the edge  $uu_{s-i}$  is still colored 1, and now the vertex  $v$  is missing the color 2. Since  $P_{weak}(i)$  is true the fan  $X_v^{\beta'}(1)$  is not a path, this is a contradiction.  $\square$

The next lemma deals with  $(\mathcal{V}, u)$ -independent cycles.

**Lemma 2.5.23.** *Let  $i \geq 0$ ,  $\mathcal{V}$  be a minimum cycle in a coloring  $\beta$ ,  $u$  and  $u'$  two vertices of  $\mathcal{V}$ ,  $\mathcal{U} = X_u(m(u')) = (uu_1, \dots, uu_l)$ ,  $h \leq i$  such that  $\beta(uu_{l-h}) = m(v)$ ,  $c'$  a color not in  $\beta(\mathcal{V})$  such that  $\mathcal{Y} = X_u(c') = (uy_1, \dots, uy_r)$  is a  $(\mathcal{V}, u)$ -independent cycle different from  $\mathcal{U}$  and  $\mathcal{X} = X_v(c') = (vx_1, \dots, vx_s)$  is a cycle different from  $\mathcal{V}$  with  $y_r = x_s = z$ , and  $c''$  a color in  $\beta(\mathcal{V})$ . If  $P(j)$  is true for all  $j \leq i$ , then  $\mathcal{Z} = X_z(c'')$  is not a path.*

*Proof.* Without loss of generality, we assume that the vertices  $v$ ,  $u$  and  $u'$  are respectively missing the colors 1, 2, and 3; we also assume that  $c' = 4$ . Note that since  $\mathcal{U}$  and  $\mathcal{Y}$  are different cycles, we have  $\beta(\mathcal{U}) \cap \beta(\mathcal{Y}) = \{m(u)\} = \{2\}$ , and since  $\mathcal{X}$  and  $\mathcal{V}$  are different cycles, we have that  $\beta(\mathcal{V}) \cap \beta(\mathcal{X}) = \{m(v)\} = 1$ . Assume that the fan  $\mathcal{Z}$  is a path. The fan  $\mathcal{V}$  is a minimum cycle, so by Lemma 2.3.13, the fan  $\mathcal{U}$  is a cycle entangled with  $\mathcal{V}$ , and thus  $u_l = u'$ .

We first invert  $\mathcal{Z}$  until we reach a coloring  $\beta'$  where  $m(z) = c \in (\beta(\mathcal{V}) \cup \beta(\mathcal{X}) \cup \beta(\mathcal{Y})) \setminus \{4\}$ . The coloring  $\beta'$  is  $\mathcal{V}$ -equivalent to  $\beta$ , so by Observation 2.3.9, the cycle  $\mathcal{V}$  is the same minimum cycle in the coloring  $\beta'$ . The coloring  $\beta'$  is also  $\mathcal{U}$ -equivalent to  $\beta$ , so, in the coloring  $\beta'$ , the fan  $X_u(3)$  is exactly  $\mathcal{U}$ . Since the property  $P(j)$  is true for all  $j \leq h$ , for any  $j \leq h$  such that  $\beta(uu_{l-j}) \neq 1$ , the fan  $X_v(\beta(uu_{l-j}))$  is a saturated cycle containing  $u_{l-j-1}$ .

We first show that  $c \notin \beta(\mathcal{V})$ . Otherwise, assume that  $c \in \beta(\mathcal{V})$ , then  $c \notin \beta(\mathcal{Y})$  since  $\mathcal{Y}$  is a  $(\mathcal{V}, u)$ -independent cycle, and  $c \notin \beta(\mathcal{X})$  since  $\mathcal{X}$  is different from  $\mathcal{V}$ . So the coloring  $\beta'$  is  $(\mathcal{X} \cup \mathcal{Y} \setminus \{z\})$ -equivalent to  $\beta$ . Hence, in the coloring  $\beta'$ , the fans  $X_u(4)$  and  $X_v(4)$  still contain the vertex  $z$ . If  $c = 1$ , then in the coloring  $\beta'$ , since the fan  $X_u(4)$  still contains the vertex  $z$ , we have that  $X_u(4)_{\leq z}$  is a  $(\mathcal{V}, u)$ -independent subfan avoiding  $v$ . However, the fan  $X_v(4)$  is now a path containing  $z$ , by Lemma 2.5.4, we have a contradiction. So  $c \neq 1$ . Since the fan  $\mathcal{V}$  is a minimum cycle in the coloring  $\beta'$ , it is saturated by Lemma 2.3.4, thus  $z \notin K_v(1, c)$ . We now swap the component  $C_{1,c} = K_z(1, c)$ , and denote by  $\beta''$  the coloring obtained after the swap. The coloring  $\beta''$  is  $\mathcal{V}$ -equivalent to  $\beta'$ , so  $\mathcal{V}$  is still a minimum cycle in the coloring  $\beta''$  by Observation 2.3.9. The coloring  $\beta''$  is also  $(X_u(4)_{\leq z} \cup X_v(4))$ -equivalent to  $\beta'$ , so the fan  $X_u(4)$  still contains the vertex  $z$  which is now missing the color 1. Similarly to the previous case, the subfan  $X_u(4)_{\leq z}$  is now a  $(\mathcal{V}, u)$ -independent subfan avoiding  $v$ , and  $X_v(4)$  is now a path; again by Lemma 2.5.4, we have a contradiction. Without loss of generality, we assume that  $c = 5$ .

*Case 9* ( $5 \notin \beta(\mathcal{X})$ ).

In this case, the coloring  $\beta'$  is  $(\mathcal{X} \setminus \{z\})$ -equivalent to  $\beta$ , and so in the coloring  $\beta'$ , the fan  $X_v(4)$  still contains the vertex  $z$  which is now missing the color 5.

*Subcase 9.1* ( $5 \in \beta(\mathcal{U}_{<u_{l-h}})$ ).

Let  $z'$  be the vertex of  $\mathcal{U}_{<u_{l-h}}$  missing the color 5. If the vertex  $z'$  does not belong to  $K_v(1, 5)$ , then we swap the component  $C_{1,5} = K_{z'}(1, 5)$ , and denote by  $\beta''$  the coloring obtained after the swap. The coloring  $\beta''$  is clearly  $\mathcal{V}$ -equivalent to  $\beta'$ , so by Observation 2.3.9, the cycle  $\mathcal{V}$  is still the same minimum cycle in the coloring  $\beta''$ . Since in the coloring  $\beta'$ , there is no edge colored 1 or 5 in  $\mathcal{U}_{<u_{l-h}}$ , the coloring  $\beta''$  is also  $\mathcal{U}_{<u_{l-h}}$ -equivalent to  $\beta'$ . So in the coloring  $\beta''$ , the fan  $X_u(3)$  still contains the vertex  $z'$  which is now missing the color 1, and thus  $X_u(3)$  is not entangled with  $\mathcal{V}$ . By Lemma 2.3.13, we have a contradiction. So the vertex  $z'$  belongs to  $K_v(1, 5)$ , and thus the vertex  $z$  does not belong to  $K_v(1, 5)$ . We now swap the component  $C_{1,5} = K_z(1, 5)$ , and denote by  $\beta''$  the coloring obtained after the swap. The coloring  $\beta''$  is also  $\mathcal{V}$ -equivalent to  $\beta'$ , so the fan  $\mathcal{V}$  is a minimum cycle in the coloring  $\beta''$ . Moreover, since  $5 \in \beta(\mathcal{U}_{<u_{l-h}})$ ,  $5 \notin \beta(\mathcal{Y})$ . We also have that  $5 \notin \beta(\mathcal{X})$ , so in total, the coloring  $\beta''$  is  $(\mathcal{Y} \cup \mathcal{X} \setminus \{z\})$ -equivalent to the coloring  $\beta'$ . This means that in the coloring  $\beta''$ , the fan  $X_u(4)$  still contains the vertex  $z$  which is now missing the color 1, so  $X_u(4)_{\leq z}$  is a  $(\mathcal{V}, u)$ -independent subfan avoiding  $v$ . We also have that the fan  $X_v(4)$  is now a path containing the vertex  $z$ , so by Lemma 2.5.4 we have a contradiction.

*Subcase 9.2* ( $5 \in \beta(\mathcal{U}_{\geq u_{l-h}})$ ).

Let  $s$  be such that  $m(u_{l-s}) = 5$ . The fan  $X_v(5)$  is a saturated cycle containing  $u_{l-s}$ , so the vertex  $u_{l-s}$  belongs to the component  $K_v(1, 5)$ , and the vertex  $z$  does not belong to this component. We now swap the component  $K_z(1, 5)$  and denote by  $\beta''$  the coloring obtained after the swap. Since the color 5 is not in  $\beta(X_v(4))$ , the coloring  $\beta''$  is  $(X_v(4) \setminus \{z\})$ -equivalent to  $\beta'$ . So in the coloring  $\beta''$ , the fan  $X_v(4)$  still contains the vertex  $z$  which is missing the color 1, so it is now a path. Since the color 5 is in  $\beta(\mathcal{U}_{>u_{l-h}})$ , it is not in  $\beta(\mathcal{Y})$ , so the coloring  $\beta''$  is  $(X_u(4) \setminus \{z\})$ -equivalent to  $\beta'$ , and thus  $X_u(4)$  still contains the vertex  $z$ . So the subfan  $X_u(4)_{\leq z}$  is now a  $(\mathcal{V}, u)$ -independent subfan avoiding  $v$ . By Lemma 2.5.4, the fan  $X_v(4)$  is a path not containing  $z$ ; a contradiction.

*Subcase 9.3* ( $5 \in \beta(\mathcal{Y})$ ).

Let  $z'$  be the vertex of  $\mathcal{Y}$  missing the color 5 in the coloring  $\beta$ . The vertices  $z$  and  $z'$  are both missing the color 5 in the coloring  $\beta'$ , so at least one of them is not in  $K_v(1, 5)$ . If the vertex  $z$  is not in  $K_v(1, 5)$ , then we swap the component  $C_{1,5} = K_z(1, 5)$ , and denote by  $\beta''$  the coloring obtained after the swap. The coloring  $\beta''$  is  $\mathcal{V}$ -equivalent to  $\beta'$ , so the cycle  $\mathcal{V}$  is the same minimum cycle in the coloring  $\beta''$  by Observation 2.3.9.

If the vertex  $u$  does not belong to  $C_{1,5}$ , then the fan  $X_u(5)$  now contains the

vertex  $z$  which is missing the color 1. Thus  $X_u(5)_{\leq z}$  is now a  $(\mathcal{V}, u)$ -independent subfan avoiding  $v$ , and by Lemma 2.5.4, the fan  $X_v(5)$  is a path. However,  $\beta''(uu_{l-h}) = \beta(uu_{l-h}) = 1$ , and the property  $P(j)$  is true for all  $j \leq h$ , so by Lemma 2.5.22, there is no path around  $v$ . This is a contradiction.

So the vertex  $u$  belongs to  $C_{1,5}$ , and now  $X_u(1)$  contains the vertex  $z$  which is missing the color 1. So  $X_u(1)$  is not entangled with  $\mathcal{V}$ , and by Lemma 2.3.13, we also have a contradiction.

*Case 10* ( $5 \in \beta(\mathcal{X})$ ). Let  $z'$  be the vertex of  $\mathcal{X}$  missing the color 5 in the coloring  $\beta$ .

*Subcase 10.1* ( $5 \in \beta(\mathcal{U}_{<u_{l-h}})$ ).

Let  $z''$  be the vertex of  $\mathcal{U}_{<u_{l-h}}$  missing the color 5 in the coloring  $\beta$ . Note that we may have  $z'' = z'$ . The vertices  $z$  and  $z''$  are both missing the color 5 in the coloring  $\beta'$ , so they are not both part of  $K_v(1, 5)$ . If  $z''$  is not in  $K_v(1, 5)$ , then we swap  $K_{z''}(1, 5)$ , and denote by  $\beta''$  the coloring obtained after the swap. The coloring  $\beta''$  is  $\mathcal{V}$ -equivalent to  $\beta'$ , so by Observation 2.3.9, the cycle  $\mathcal{V}$  is the same minimum cycle in the coloring  $\beta''$ . Since there is no edge colored 1 or 5 in  $E(\mathcal{U}_{\leq z''})$ , the coloring  $\beta''$  is also  $\mathcal{U}_{\leq z''}$ -equivalent to the coloring  $\beta'$ , so  $X_u(3)$  still contains the vertex  $z''$  which is now missing the color 1, so it is not entangled with  $\mathcal{V}$ , by Lemma 2.3.13, this is a contradiction.

So the vertex  $z''$  belongs to  $K_v(1, 5)$ , and thus the vertex  $z$  does not belong to this component. We swap the component  $C_{1,5} = K_z 1, 5$ , and denote by  $\beta''$  the coloring obtained after the swap. In the coloring  $\beta''$ , the fan  $X_v(5)$  still contains the vertex  $z$  which is missing the color 1, so this fan is now a path. If the vertex  $u$  does not belong to  $C_{1,5}$ , then  $\beta''(uu_{l-h}) = 1$ . Since the property  $P(j)$  is true for all  $j \leq h$ , there is no path around  $v$ , a contradiction. So the vertex  $u$  belongs to  $C_{1,5}$ . Now in the coloring  $\beta''$ , the fan  $\mathcal{U}' = X_u(3) = (uu'_1, \dots, uu'_l)$  is smaller, but for any  $j \leq h$ , we still have that  $u_{l-j} = u'_{l-j} \in V(\mathcal{U}')$ . Note that we have  $z'' = u'_{l-h-1}$ . So we have  $\mathcal{U}' = (uu'_1, \dots, uu'_{l-h-1} = uz'', uu_{l-h}, \dots, uu_l)$ . Since the property  $P(j)$  is true for all  $j \leq h$ , the fan  $X_v(\beta(uu_{l-h})) = X_v(5)$  is a cycle, a contradiction.

*Subcase 10.2* ( $5 \in \beta(\mathcal{U}_{>u_{l-h}})$ ).

Let  $s$  be such that  $m^\beta(u_{l-s}) = 5$ . In the coloring  $\beta$ , since the property  $P(s)$  is true, the fan  $X_v(5)$  is a saturated cycle containing  $u_s$ . But the color 5 is in  $\mathcal{X}$ , so the fan  $X_v(5)$  also contains the vertex  $z$ , and thus  $X_v(5) = \mathcal{X}$ . In the coloring  $\beta'$ , the fan  $X_v(5)$  still contains the vertex  $z$  which is now missing the color 5. Since the property  $P(s)$  is true, the cycle  $X_v(5)$  is a cycle containing the vertex  $u_{l-s}$ , so we have a contradiction.

*Subcase 10.3* ( $5 \in \beta(\mathcal{Y})$ ).

Let  $z''$  be the vertex of  $\mathcal{Y}$  missing the color 5 in the coloring  $\beta$ . Note that we may have  $z'' = z'$ . Since the vertices  $z$  and  $z''$  are both missing the color 5 in



the coloring  $\beta'$ , they are not both part of  $K_v(1, 5)$ . If  $z$  is not in  $K_v(1, 5)$ , then we swap the component  $K_z(1, 5) = C_{1,5}$  and denote by  $\beta''$  the coloring obtained after the swap. The coloring  $\beta''$  is  $\mathcal{V}$ -equivalent to  $\beta'$ , so by Observation 2.3.9, the cycle  $\mathcal{V}$  is the same minimum cycle in the coloring  $\beta''$ . Moreover, the coloring  $\beta''$  is also  $(X_v(5) \setminus \{z\})$ -equivalent to  $\beta'$ , so this fan is now a path containing  $z$ .

If the vertex  $u$  does not belong to  $C_{1,5}$ , then the coloring  $\beta''$  is  $(X_u(5) \setminus \{z\})$ -equivalent to  $\beta'$ , and thus  $X_u(5)$  still contains the vertex  $z$  which is now missing the color 1. So the subfan  $X_u(<)_{\leq z}$  is now a  $(\mathcal{V}, u)$ -independent subfan avoiding  $v$ , and it also contains  $z$ , by Lemma 2.5.4, the fan  $X_v(5)$  is a path that does not contain  $z$ , a contradiction.

So the vertex  $u$  belongs to  $C_{1,5}$ , and now in the coloring  $\beta''$ , the fan  $X_u(1)$  contains the vertex  $z$  which is missing the color 1. So this fan is not entangled with  $\mathcal{V}$ , by Lemma 2.3.13, we also have a contradiction.

*Subcase 10.4* ( $5 \notin (\beta(\mathcal{V}) \cup \beta(\mathcal{U}))$ ).

The vertices  $z$  and  $z'$  are both missing the color 5, so at least one of them is not in  $K_v(1, 5)$ .

If the vertex  $z$  is not in  $K_v(1, 5)$ , since  $P(j)$  is true for all  $j \leq h$ , then for all  $j \leq h$ , the vertex  $z$  is not in  $X_v(\beta(uu_{l-j}))$ . We now swap the component  $C_{1,5} = K_z(1, 5)$  to obtain a coloring  $\beta''$  where the subfan  $X_u(4)$  is now a  $(\mathcal{V}, u)$ -independent subfan avoiding  $v$ . The coloring  $\beta''$  is  $\mathcal{V}$ -equivalent to  $\beta'$ , so by Observation 2.3.9 the cycle  $\mathcal{V}$  is the same minimum cycle in the coloring  $\beta'$ . By Lemma 2.5.4, the fan  $X_v(4)$  is now a path that does not contain  $z$ . Since for all  $j \leq h$ ,  $P(j)$  is true and  $z$  does not belong to  $X_v(\beta(uu_{l-j}))$ , the coloring  $\beta''$  is also  $(\bigcup_{j \in [0, h]} X_v(\beta(uu_{l-j})))$ -equivalent to the coloring  $\beta'$ .

If the vertex  $u$  does not belong to  $C_{1,5}$ , then the coloring  $\beta''$  is also  $\mathcal{U}$  equivalent to the coloring  $\beta'$ . The edge  $uu_{l-h}$  is still colored 1, and the property  $P(j)$  is true for all  $j \leq h$ . By Lemma 2.5.22 there is no path around  $v$ , a contradiction. So the vertex  $u$  belongs to the component  $C_{1,5}$ , and the edge  $uu_{l-h}$  is now colored 5. Let  $\mathcal{U}' = X_u^{\beta''}(3) = (uu'_1, \dots, uu'_l)$ . Since  $z \notin X_v(\beta(uu_{l-j}))$  for all  $j \leq h$ , the coloring  $\beta''$  is  $(\bigcup_{j \in [0, h]} X_v(\beta(uu_{l-j})))$ -equivalent to the coloring  $\beta'$ , and it is also

$\mathcal{U}_{>u_{l-h}}$ -equivalent to the coloring  $\beta'$ , so by Lemma 2.5.21, for all  $j \leq h$ , we have  $u'_{l-j} = u_{l-j}$ . In particular,  $u'_{l-h} = u_{l-h}$ . The coloring  $\beta''$  is  $X_u(5)_{< z}$ -equivalent to the coloring  $\beta'$ , so in the coloring  $\beta''$ , the fan  $X_u(5)$  still contains the vertex  $z$  which is now missing the color 1, therefore the fan  $X_u(5)$  is a path. Since  $P(h)$  is true, we have a contradiction.

So the vertex  $z$  belongs to  $K_v(1, 5)$ , and the vertex  $z'$  does not belong to this component. We now swap the component  $C_{1,5} = K_{z'}(1, 5)$ , and obtain a coloring  $\beta''$  that is  $\mathcal{V}$ -equivalent to  $\beta'$ . By Observation 2.3.9, the fan  $\mathcal{V}$  is the same minimum cycle in the coloring  $\beta''$ . Since the property  $P(j)$  is true for all  $j \leq h$ ,

and  $z'$  is not in  $K_v(1, 5)$ , then for all  $j \leq h$ , the vertex  $z'$  is not in  $X_v(\beta(uu_{l-j}))$ , and the coloring  $\beta''$  is  $(\bigcup_{j \in [0, h]} X_v(\beta(uu_{l-j})))$ -equivalent to the coloring  $\beta'$ . In the coloring  $\beta''$ , the fan  $X_v(4)$  is now a path, so similarly to the previous case, the vertex  $u$  belongs to the component  $C_{1,5}$ . Therefore, in the coloring  $\beta''$ , the edge  $uu_{l-h}$  is colored 5.

Let  $\mathcal{U}' = (uu'_1, \dots, uu'_h)$ . Since the coloring  $\beta''$  is  $(\bigcup_{j \in [0, h]} X_v(\beta(uu_{l-j})))$ -equivalent to the coloring  $\beta'$ , by Lemma 2.5.21, for any  $j \leq h$  we have  $u'_{l-j} = u_{l-j}$ . The coloring  $\beta''$  is  $\mathcal{U}_{\leq v}$  equivalent to  $\beta'$ , so  $v$  is in  $\mathcal{U}''$ , and thus we have  $X_u(1) = X_u(5) = \mathcal{U}'$ . So there exists a vertex  $z''$  missing the color 5 in the fan  $X_u(1)$ . Note that since  $m(z') = 1$  and  $m(z'') = 5$  we have  $z \neq z''$ , however, we may have  $z'' = z$ , and in this case there exists a vertex in  $X_u(1)$  missing a color in  $\beta(X_u(4)_{\leq z})$ . We now have to distinguish the cases.

*Subsubcase 10.4.1 ( $z'' \neq z$ ).*

We consider the coloring  $\beta'$ . In this coloring, the vertex  $z''$  is in  $X_u(5)$  since  $u$  is in  $C_{1,5}$ . If the vertex  $z''$  also belongs to  $C_{1,5}$ , then now  $X_u(5)_{\leq z''}$  is a subfan avoiding  $v$ . If there is an edge  $uu''$  in  $E(X_u(5)_{\leq z''})$  colored with a color in  $\beta'(\mathcal{V})$  then the fan  $X_u(\beta'(uu''))$  is not entangled with  $\mathcal{V}$ , and by Lemma 2.3.13 we have a contradiction. So the subfan  $X_u(5)_{\leq z''}$  is a  $(\mathcal{V}, u)$ -independent subfan avoiding  $v$ . By Lemma 2.5.4 the fan  $X_v(5)$  is a path, however, in the coloring  $\beta'$  the fan  $X_v(5)$  still contains the vertex  $z$  that is missing the color 5, so  $X_v(5)$  is a cycle, a contradiction.

So the vertex  $z''$  does not belong to  $C_{1,5}$ , and thus is still missing the color 5 in the coloring  $\beta'$ . We now swap the component  $K_{z''}(1, 5)$  to obtain a coloring  $\beta_f$  where  $X_u(5)_{\leq z''}$  is a  $(\mathcal{V}, u)$ -independent subfan avoiding  $v$ , and where  $X_u(5)$  is a cycle. Again by Lemma 2.5.4 we have a contradiction.

*Subsubcase 10.4.2 ( $z'' = z'$ ).*

So there exists a vertex  $w$  in  $X_u(5)$  such that  $m(w) \in \beta'(X_u(4)_{\leq z})$  and  $w \notin V(X_u(4)_{\leq z})$ . We now need to distinguish whether or not  $m(w) = 4$ .

*Subsubsubcase 10.4.1 ( $m(w) \neq 4$ ).*

In this case, without loss of generality, assume that  $m(w) = 6$ , and let  $w'$  be the vertex of  $X_v(4)_{\leq z}$  missing the color 6. The vertices  $w$  and  $w'$  are both missing the color 6, so they are not both part of  $K_v(1, 6)$ .

If  $w'$  is not in  $K_v(1, 6)$ , then we swap  $C_{1,6} = K_{w'}(1, 6)$  to obtain a coloring  $\beta''$  where  $X_u(4)_{\leq w'}$  is a  $(\mathcal{V}, u)$ -independent subfan avoiding  $v$ . The coloring  $\beta''$  is  $\mathcal{V}$ -equivalent to  $\mathcal{V}$ , so the fan  $\mathcal{V}$  is still the same minimum cycle in the coloring  $\beta'$  by Observation 2.3.9. So by Lemma 2.5.4 the fan  $X_v(4)$  is a path that does not contain  $w'$ . If the vertex  $u$  does not belong to  $C_{1,6}$ , then the coloring  $\beta''$  is  $\mathcal{U}$ -equivalent to  $\beta'$ , the property  $P(j)$  is true for all  $j \leq h$  and  $\beta''(uu_{l-h}) = 1$  so by Lemma 2.5.22 there is no path around  $v$ , a contradiction.

## 2. Vizing's edge-coloring conjecture

---

So the vertex  $u$  belongs to  $C_{1,6}$ , and we have  $\beta''(uu_{l-h}) = 6$ . Let  $\mathcal{U}' = X_u^{\beta''}(3) = (uu'_1, \dots, uu'_l)$ . The coloring  $\beta''$  is  $(\bigcup_{j \in [0, h]} X_v(\beta(uu_{l-j})))$ -equivalent to the coloring  $\beta'$  and is  $\mathcal{U}_{>u_{l-h}}$ -equivalent to the coloring  $\beta'$  so by Lemma 2.5.21, for all  $j \leq h$  we have  $u'_{l-j} = u_{l-j}$ . In the coloring  $\beta'$ , the fan  $X_v(4)$  contains the vertex  $z'$  missing the color 5, and the fan  $X_v(5)$  is a cycle that contains the vertex  $z$ , and in the coloring  $\beta''$ , the fan  $X_u(4)$  is a path. So there exists a vertex  $w''$  in  $X_v(4)$  that is missing the color 6 in the coloring  $\beta'$  and that belongs to  $C_{1,6}$ . This vertex is now missing the color 1 in the coloring  $\beta''$ . If  $w''$  is in  $X_v^{\beta'}(4)_{\leq z'}$ , then the fan  $X_v^{\beta''}(6)$  is now a comet containing two vertices ( $z$  and  $z'$ ) missing the color 5. Since the property  $P(h)$  is true, we have a contradiction. So the vertex  $w''$  is in  $X_v^{\beta'}(5)$ . But now, in the coloring  $\beta''$ , the fan  $X_v(6)$  contains the vertex  $z$  which is still missing the color 5, and the fan  $X_v(5)$  is a path, so the fan  $X_v(6)$  is a path. Again since  $P(h)$  is true, we have a contradiction. So the vertex  $w'$  belongs to  $K_v(1, 6)$ .

Therefore, the vertex  $w$  does not belong to  $K_v(1, 6)$ , and we swap the component  $C_{1,6} = K_w(1, 6)$  to obtain a coloring  $\beta''$  where  $X_u(5)_{\leq w}$  is a subfan avoiding  $v$ . The coloring  $\beta''$  is  $\mathcal{V}$ -equivalent to the coloring  $\beta'$ , so by Observation 2.3.9, the fan  $\mathcal{V}$  is the same minimum cycle in the coloring  $\beta''$ . Similarly to the previous case, the subfan  $X_u(5)_{\leq w}$  is a  $(\mathcal{V}, u)$ -independent subfan avoiding  $v$ , so  $X_v(5)$  is a path, and the vertex  $u$  belongs to  $C_{1,6}$ . Since the vertex  $z$  is still missing the color 5, it means that in the coloring  $\beta''$  the fan  $X_u(1)$  now contains the vertex  $w$  which is missing the color 1, and so it is not entangled with  $\mathcal{V}$ . By Lemma 2.3.13 we have a contradiction.

*Subsubsubcase 10.4.2 ( $m(w) = 4$ ).*

Since the fan  $\mathcal{V} = X_z(5)$  is a path in the coloring  $\beta$ , the fan  $X_z(4)$  is a path in the coloring  $\beta'$ . In the coloring  $\beta'$  we invert the path  $X_z(5)$  until we reach a coloring where  $m(z) \in \beta'(X_u(5)_{\leq w})$  and denote by  $\beta''$  the coloring obtained after the inversion. Note that since  $4 \in \beta'(X_z(5)) \cap \beta(X_u(5)_{\leq w})$  the inversion is well defined. The coloring  $\beta''$  is  $\mathcal{V}$ -equivalent to  $\beta'$  so the fan  $\mathcal{V}$  is the same minimum cycle in the coloring  $\beta''$ . The coloring  $\beta''$  is also  $\mathcal{U}$ -equivalent to  $\beta'$ , so  $X_u^{\beta''}(3) = \mathcal{U}$  and since  $P(j)$  is true for all  $j \leq h$ , the fan  $X_v(\beta''(uu_{l-j}))$  is a saturated cycle if  $\beta''(uu_{l-j}) \neq 1$ . The coloring  $\beta''$  is  $(X_v(4) \setminus \{z\})$ -equivalent to  $\beta'$ , so the fan  $X_v(4)$  still contains the vertex  $z'$  which is missing 5, and the vertex  $z$ . Finally, the coloring  $\beta''$  is  $X_u(5)_{\leq w}$ -equivalent to the coloring  $\beta'$ . Let  $c_z$  be the missing color of  $z$  in  $\beta''$ , and let  $w'$  be the vertex of  $X_u(5)_{\leq w}$  missing the color  $c_z$ . Note that if  $c_z = 4$ , then we have  $w' = w$ .

The proof is similar to the previous case, and we now consider the components of  $K(1, c_z)$ . The vertices  $z$  and  $w'$  are both missing the color  $c_z$  so at least one of them is not in  $K_v(1, c_z)$ . If the vertex  $z$  is not in  $K_v(1, c_z)$ , then we swap the component  $C_{1, c_z} = K_z(1, c_z)$  to obtain a coloring  $\beta_f$  that is  $\mathcal{V}$ -equivalent

to  $\beta''$ . By Observation 2.3.7 the fan  $\mathcal{V}$  is the same minimum cycle in the coloring  $\beta_f$ , and now  $X_u(4)_{\leq z}$  is a  $(\mathcal{V}, u)$ -independent subfan avoiding  $v$ , so by Lemma 2.5.4 the fan  $X_v(4)$  is now a path not containing  $z$ . Note that the coloring  $\beta_f$  is also  $(\bigcup_{j \in [0, h]} X_v(\beta(uu_{l-j})))$ -equivalent to the coloring  $\beta''$ . If the vertex  $u$  does not belong to  $C_{1, c_z}$ , then the coloring  $\beta_f$  is  $\mathcal{U}$ -equivalent to  $\beta''$ , and in particular  $\beta_f(uu_{l-h}) = 1$ . Since  $P(j)$  is true for all  $j \leq h$ , by Lemma 2.5.22 there is no path around  $v$ , a contradiction.

So the vertex  $u$  belongs to  $C_{1, c_z}$ , and now  $\beta_f(uu_{l-h}) = 6$ . Since the fan  $X_v(4)$  is now a path that does not contain  $z$ , it means that in the coloring  $\beta''$  there is a vertex  $w''$  in  $X_v(4)$  which is missing the color  $c_z$  and which also belongs to  $C_{1, c_z}$ . It means that in the coloring  $\beta_f$ , the fan  $X_v(c_z)$  is now a path containing  $z$ . Let  $\mathcal{U}' = X_u^{\beta_f}(3) = (uu'_1, \dots, uu'_l)$ . The coloring  $\beta_f$  is  $\mathcal{U}_{> u_{l-h}}$ -equivalent to  $\beta''$  and is also  $(\bigcup_{j \in [0, h]} X_v(\beta(uu_{l-j})))$ -equivalent to  $\beta''$ , so for all  $j \leq h$ , we have  $u'_{l-j} = u_{l-j}$  by Lemma 2.5.21. In particular  $u'_{l-h} = u_{l-h}$ . Since  $P(h)$  is true, and  $\beta_f(uu'_{l-h}) = c_z$ , the fan  $X_v(c_z)$  is a cycle, a contradiction.

So the vertex  $z$  belongs to  $K_v(1, c_z)$  and the vertex  $w'$  does not belong to this component. We now swap the component  $C_{1, c_z} = K_w(1, c_z)$  and denote by  $\beta_f$  the coloring obtained after the swap. The coloring  $\beta_f$  is  $\mathcal{V}$ -equivalent to  $\beta''$  so by Observation 2.3.7 the fan  $\mathcal{V}$  is the same minimum cycle in the coloring  $\beta_f$ . The coloring  $\beta_f$  is also  $(\bigcup_{j \in [0, h]} X_v(\beta(uu_{l-j})))$ -equivalent to the coloring  $\beta''$ . In the coloring  $\beta_f$  the subfan  $X_u(5)_{\leq w'}$  is now a subfan avoiding  $v$ . If there is an edge  $uu''$  in  $E(X_u(5)_{\leq w'})$  colored with a color in  $\beta_f(\mathcal{V})$ , then  $X_u(\beta_f(uu''))$  is not entangled with  $\mathcal{V}$  and by Lemma 2.3.13 we have a contradiction. So the subfan  $X_u(5)_{\leq w'}$  is a  $(\mathcal{V}, u)$ -independent subfan avoiding  $v$  and thus by Lemma 2.5.4 the fan  $X_v(5)$  is now a path that does not contain  $w'$ . Similarly to the previous case, this means that the vertex  $u$  belongs to the component  $C_{1, c_z}$ , and thus that  $\beta_f(uu_{l-h}) = c_z$ . The fan  $X_v(5)$  still contains the vertex  $z$  which is missing the color  $c_z$ , and the fan  $X_v(5)$  is a path, so the fan  $X_v(c_z)$  is a path. Let  $\mathcal{U}' = X_u^{\beta_f}(3) = (uu'_1, \dots, uu'_l)$ . Since  $P(j)$  is true for all  $j \leq h$  and since the coloring  $\beta_f$  is  $(\bigcup_{j \in [0, h]} X_v(\beta(uu_{l-j})))$ -equivalent to the coloring  $\beta''$ , by Lemma 2.5.21 for  $j \leq h$ , we have  $u'_{l-j} = u_{l-j}$ . In particular,  $u'_{l-h} = u_{l-h}$ . The edge  $uu'_{l-h}$  is now colored  $c_z$  and the property  $P(h)$  is true, so the fan  $X_v(c_z)$  is a cycle. This is a contradiction. □

Before proving the induction step of the proof we need to introduce a new property implied by  $P(i)$ .

### 2.5.5 The property $Q(i)$

**Definition 2.5.24.** Let  $i \geq 0$ , we define the property  $Q(i)$  as follows:

For any minimum cycle  $\mathcal{V}$  in a coloring  $\beta$ , for any pair of vertices  $u$  and  $u'$  of  $\mathcal{V}$ , let  $\mathcal{U} = X_u(m(u')) = (uu_1, \dots, uu_l)$ . If  $\beta(uu_{l-i}) \neq m(v)$ , then for any color  $c \in \beta(\mathcal{V})$ , the fan  $X_{u_{l-i-1}}(c)$  is a cycle entangled with  $\mathcal{V}$  and  $\mathcal{U}_{\geq u_{l-i-2}}$ .

We now prove that the property  $Q(i)$  is implied by the property  $P(i)$ . And we first prove the following lemma concerning saturated cycles around the central vertex of a minimum cycle.

**Lemma 2.5.25.** Let  $\mathcal{V} = (vv_1, \dots, vv_k)$  be a minimum cycle in a coloring  $\beta$ ,  $u = v_j$  and  $u' = v_{j'}$  two vertices of  $\mathcal{V}$  and  $\mathcal{W} = (vw_1, \dots, vw_t)$  a saturated cycle around  $v$ . Then the fans  $\mathcal{W}$  and  $\mathcal{U} = X_u(m(u'))$  are entangled.

*Proof.* By Lemma 2.3.13, the fan  $\mathcal{U}$  is a cycle entangled with  $\mathcal{V}$ , so if  $\mathcal{W} = \mathcal{V}$ , the fans  $\mathcal{W}$  and  $\mathcal{U}$  are entangled as desired. So assume that  $\mathcal{W} \neq \mathcal{V}$  and that  $\mathcal{W}$  is not entangled with  $\mathcal{U}$ . Without loss of generality, we assume that the vertices  $v$ ,  $u$  and  $u'$  are respectively missing the colors 1, 2, and 3. Since  $\mathcal{W} \neq \mathcal{V}$  and  $\mathcal{W}$  is centered at  $v$ , we have that  $\beta(\mathcal{W}) \cap \beta(\mathcal{V}) = \{1\}$ . Since  $\mathcal{W}$  and  $\mathcal{U}$  are not entangled, there exists  $c \in \beta(\mathcal{U}) \cap \beta(\mathcal{W})$  such that  $M(\mathcal{U}, c) \neq M(\mathcal{W}, c)$ . Without loss of generality, since  $c \notin \{1, 2, 3\}$ , we assume that  $c = 4$  and that  $u_i = M(\mathcal{U}, 4)$  is the first such vertex in  $\mathcal{U}$ ; up to shifting the indices in  $\mathcal{W}$ , we also assume that  $m(w_t) = 4$ , and thus that  $\mathcal{W} = X_v(4)$ .

Since the cycle  $\mathcal{W}$  is saturated, the vertex  $w_t$  belongs to  $K_v(1, 4)$ , so the vertex  $z$  does not belong to  $K_v(1, 4)$ . We swap the component  $C_{1,4} = K_z(1, 4)$  and denote by  $\beta_2$  the coloring obtained after the swap.

If  $u \notin C_{1,4}$ , or there is no edge colored 1 in  $\mathcal{U}_{<i}$ , then the coloring  $\beta_2$  is  $(\mathcal{V} \cup \mathcal{W} \cup \mathcal{U}_{<i})$ -equivalent to  $\beta$ . Hence, in the coloring  $\beta_2$ , the fan  $\mathcal{V}$  is a minimum cycle by Observation 2.3.9, but now the fan  $X_u(m(u')) = (uu_1, \dots, uu_i)$  is now a path, by Lemma 2.3.13, this is a contradiction.

So  $u \in C_{1,4}$ , and there is an edge colored 1 in  $\mathcal{U}_{<i}$ . Since by Lemma 2.3.13, the cycle  $\mathcal{U}$  is entangled with  $\mathcal{V}$ , the edge  $uv_{j-1}$  and the edge  $uv$  are in  $E(\mathcal{U})$ . We denote by  $x$  the vertex connected to  $u$  by the edge colored 1 and by  $c_{j-1}$  the missing color of  $v_{j-1}$  in  $\beta$ . Note that we may have  $v_{j-1} = u'$ , and thus  $c_{j-1} = 2$ . The fan  $\mathcal{U}$  is of the form  $(uu_1, \dots, uv_{j-1}, uv, ux, \dots, uu_i, \dots, uu')$ . The coloring  $\beta_2$  is  $(\mathcal{V})$ -equivalent to  $\beta$ , so by Observation 2.3.9, the cycle  $\mathcal{V}$  is a minimum cycle in  $\beta_2$ . But now the fan  $X_u(4)$  is a comet where  $v$  and  $u_i$  are missing the same color 1, more precisely,  $X_u(4) = (ux, \dots, uu_i, \dots, uu', uu_1, \dots, uv_{j-1}, uv)$ . Note that  $X_u(3)$  is a cycle which is a subsequence of  $X_u(4)$ . If there is an edge colored with a color  $c \in \beta(\mathcal{V})$  in  $X_u(4)$  between the edges  $ux$  and  $uu_i$ , then the fan  $X_v(c)$  is a comet, which is a contradiction by Lemma 2.3.13.

So there is no edge colored with a color  $c \in \beta(\mathcal{V})$  in  $X_u(4)$  between the edges  $ux$  and  $uu_i$ . Since the fan  $\mathcal{V}$  is a minimum cycle, it is saturated by Lemma 2.3.4, so  $u \in K_v(1, 2)$ , and thus  $u_i \notin K_v(1, 2)$ . We now swap the component  $K_{u_i}(1, 2)$  to obtain a coloring  $\beta_3$ . The coloring  $\beta_3$  is  $(\mathcal{V} \cup \mathcal{W})$ -equivalent to  $\beta_2$ , so the fan  $\mathcal{V}$  is a minimum cycle in  $\beta_3$  by Observation 2.3.9.

We now show that  $\mathcal{V}$  is invertible in the coloring  $\beta_3$ . The cycle  $\mathcal{V}$  is tight by Observation 2.3.10, so the vertex  $u$  belongs to the component  $C_{2,j-1} = K_{v_{j-1}}(2, c_{j-1})$ , thus the edges  $vu$  and  $vv_{j+1}$  also belong to  $C_{2,j-1}$ . In the coloring  $\beta_3$ , the fan  $X_u(4)$  is now a path that we invert until we reach a coloring  $\beta_4$  where  $m(u) \in \beta(\mathcal{W})$ . Note that since  $4 \in \beta(\mathcal{W})$ , the inversion is well-defined and moreover, since  $\beta_3$  is also  $(\mathcal{W})$ -equivalent to  $\beta$ , we have  $\beta_3(\mathcal{W}) = \beta(\mathcal{W})$ . Since  $u \notin \mathcal{W}$ , by Observation 2.3.6, the coloring  $\beta_4$  is  $(\mathcal{W})$ -equivalent to  $\beta_3$ , so  $\mathcal{W}$  is still the same cycle in  $\beta_4$ . Moreover, since  $\beta_3(X_u(4)) \cap \beta_3(\mathcal{V}) = \{2\}$ , the coloring  $\beta_4$  is  $(\mathcal{V} \setminus \{u\} \cup C_{2,j-1})$ -equivalent to  $\beta_3$ .

We denote by  $w_s$  the vertex of  $\mathcal{W}$  such that  $m^{\beta_4}(u) = m^{\beta_4}(w_s)$ , and we denote by  $c_s$  this missing color. Note that we may have that  $w_t = w_s$ , and thus  $c_s = 4$ . The vertices  $u$  and  $w_s$  are missing the same color  $c_s$ , so they are not both part of the component  $K_v(1, c_s)$  and we now have to distinguish the cases.

*Case 11* ( $u \notin K_v(1, c_s)$ ). In this case, we swap the component  $C_{1,c_s} = K_u(1, c_s)$  and obtain a coloring that we denote by  $\beta_5$ . Since  $\{1, c_s, 2, c_{j-1}\} = 4$ , the coloring  $\beta_5$  is  $(C_{2,j-1})$ -equivalent to  $\beta_4$ , so it is  $(C_{2,j-1})$ -equivalent to  $\beta_3$ . In the coloring  $\beta_5$ , the vertex  $u$  is now missing the color 1, so the fan  $X_v(m(u)) = (vv_{j+1}, \dots, vv_{j-1}, vu)$  is now a path that we invert, we denote by  $\beta_6$  the coloring obtained after the inversion. In the coloring  $\beta_6$ , the vertices  $v_{j+1}$  and  $v$  are missing the color 2, and the vertex  $u$  is missing the color  $c_{j-1}$ . So now the component  $C'_{2,j-1} = K_{v_{j-1}}$  is exactly  $C_{2,j-1} \cup \{vv_{j-1}\} \setminus \{vu, vv_{j+1}\}$  and we swap it. After this swap, the vertices  $v$  and  $u$  are missing the same color  $c_{j-1}$ , and the edge  $uv$  is colored 1; we swap this edge and we denote by  $\beta_7$  the coloring obtained after the swap. In the coloring  $\beta_7$ , the vertex  $u$  is missing the color 1, so the component  $K_u(1, c_s)$  is now exactly  $C_{1,c_s}$ , so we swap back this component. Note that since  $\{1, 2, c_s, c_{j-1}\} = 4$ , we can swap back  $C_{1,c_s}$  before  $C'_{2,j-1}$ . In the coloring obtained after the swap, the fan  $X_u(2)$  is now a path that we invert, and we denote by  $\beta_8$  the coloring obtained after the inversion. In the coloring  $\beta_8$ , the vertex  $u$  is now missing the color 2, so the component  $K_{v_{j-1}}(2, c_{j-1})$  is now exactly  $C'_{2,j-1} \cup \{uv\}$ . After swapping back this component we obtain exactly  $\mathcal{V}^{-1}(\beta_3)$ , a contradiction.

*Case 12* ( $u \in K_v(1, c_s)$ ). The principle is the same as in the previous case, but instead of changing the missing color of  $u$ , we will change the missing of  $v$  using the fan  $X_v(c_s)$  to transform  $\mathcal{V}$  into a path. As  $u$  belongs to  $K_v(1, c_s)$ , the vertex  $w_s$  does not belong to this component. So we swap the component

## 2. Vizing's edge-coloring conjecture

---

$C_{1,c_s} = K_{w_s}(1, c_s)$  to obtain a coloring where  $X_v(c_s)$  is now a path that we invert; we denote by  $\beta_5$  the coloring obtained after the inversion. Note that since  $X_v(c_s)$  was a cycle in  $\beta_4$ , we have  $\beta_4(X_v(c_s)) \cap \beta_4(\mathcal{V}) = \{1\}$ , and so  $\{2, c_{j-1}\} \cap \beta_4(X_v(c_s)) = \emptyset$ . Hence the coloring  $\beta_5$  is  $(C_{2,j-1})$ -equivalent to the coloring  $\beta_4$ . In the coloring  $\beta_5$ , the fan  $X_v(2) = (vv_{j+1}, \dots, vu)$  is now a path that we invert, and we denote by  $\beta_6$  the coloring obtained after the swap. Similarly to the previous case, in the coloring  $\beta_6$ , the vertices  $v$  and  $v_{j+1}$  are missing the color 2, and the vertex  $u$  is missing the color  $c_{j-1}$ . So in the coloring  $\beta_6$ , the component  $C'_{2,j-1} = K_{v_{j-1}}(2, c_{j-1})$  is exactly  $C_{2,j-1} \cup \{vv_{j-1}\} \setminus \{vv_{j+1}, vu\}$ , and we swap it to obtain a coloring where the vertices  $u$  and  $v$  are missing the color  $c_{j-1}$  and where the edge  $uv$  is colored  $c_s$ . After swapping the edge  $uv$ , we obtain a coloring where, the fan  $X_v(1)$  is now a path that we invert, we denote by  $\beta_7$  the coloring obtained after the inversion. In the coloring  $\beta_7$ , the component  $K_{w_s}(1, c_s)$  is exactly  $C_{1,c_s}$  and we swap back this component. Note that since  $|\{1, 2, c_s, c_{j-1}\}| = 4$ , we can swap back this component before  $C'_{2,j-1}$ . In the coloring obtained after the swap, the fan  $X_u(2)$  is now a path that we invert, we denote by  $\beta_8$  the coloring obtained after the swap. In the coloring  $\beta_8$ , the vertex  $u$  is now missing the color 2, so the component  $K_{v_{j-1}}(2, c_{j-1})$  is now exactly  $C'_{2,j-1} \cup \{vu\}$  and we swap back this component to obtain  $\mathcal{V}^{-1}(\beta_3)$  as desired.  $\square$

**Lemma 2.5.26.** *Let  $i \geq 0$ , if  $P(i)$  is true for all  $j \leq i$ , then  $Q(j)$  is true for all  $j \leq i$ .*

*Proof.* Let  $i \geq 0$ ,  $\mathcal{V}$  be a minimum cycle in a coloring  $\beta$ ,  $u$  and  $u'$  two vertices of  $\mathcal{V}$ ,  $\mathcal{U} = X_u(m(u')) = (uu_1, \dots, uu_l)$ , and assume that  $P(j)$  is true for all  $j \leq i$ . Without loss of generality, we assume that the vertices  $v$ ,  $u$  and  $u'$  are respectively missing the colors 1, 2, and 3. Let  $t \leq i$ , and  $z = u_{l-t-1}$ . We prove that  $Q(t)$  is true.

**Claim 5.** *The vertex  $z$  is not missing a color in  $\beta(\mathcal{V})$ .*

*Proof.* Otherwise, assume that  $m(z) \in \beta(\mathcal{V})$ . The fan  $\mathcal{V}$  is a minimum cycle in  $\beta$  so by Lemma 2.3.13, then fan  $\mathcal{U}$  is a cycle entangled with  $\mathcal{V}$ .

If  $m(z) \neq 1$ , then since  $\mathcal{U}$  is a cycle entangled with  $\mathcal{V}$  by Lemma 2.3.13, we have  $z \in V(\mathcal{V})$  so by Lemma 2.3.13 for any color  $c \in \beta(\mathcal{V})$ ,  $X_z(c)$  is a cycle entangled with  $\mathcal{V}$ . Moreover, since the property  $P(t)$  is true, so  $X_v(\beta(uz)) = (vw_1, \dots, w_x)$  is a saturated cycle, and by Lemma 2.5.25 is entangled with  $\mathcal{U} = X_u(m(u'))$  and  $X_z(m(u)) = (zz_1, \dots, zz_r)$ , and thus  $u_{l-t-2} = w_x = z_{r-1}$ , so  $Q(t)$  is true.

If  $m(z) = 1$ , then since  $\mathcal{U}$  is entangled with  $\mathcal{V}$ , we have  $z = v$ . So for any  $c \in \beta(\mathcal{V})$ ,  $X_z(c) = \mathcal{V}$  and thus is a cycle entangled with  $\mathcal{V}$ . Moreover, this means

that  $\beta(uz) = \beta(uv)$  and thus  $m(u_{l-t-2}) = \beta(uv)$ , so  $u_{l-t-2}$  is the vertex just before  $u$  in the cycle  $\mathcal{V}$ . By definition of  $\mathcal{V}$ , the fan  $X_z(m(u))$  contains this vertex, and thus  $Q(t)$  is true. In both cases, we have a contradiction.  $\square$

**Claim 6.** *There is no edge in  $E(\mathcal{U}_{>z})$  colored with a color  $\beta(\mathcal{V})$ .*

*Proof.* We first prove that there is no vertex in  $V(\mathcal{U}_{>z}) \setminus \{u'\}$  missing a color  $c \in \beta(\mathcal{V})$ . Otherwise, assume that there exists such a vertex  $z'$ . The cycle  $\mathcal{V}$  is minimum in  $\beta(\mathcal{V})$ , so by Lemma 2.3.13, the fan  $\mathcal{U}$  is entangled with  $\mathcal{V}$ . If  $c \neq 1$ , then  $z' \in V(\mathcal{V})$ . By Lemma 2.3.13, the fan  $\mathcal{U}' = X_u(m(z')) = (uu'_1, \dots, uu'_l)$  is a cycle entangled with  $\mathcal{V}$ , so  $u'_l = z'$  and  $V(\mathcal{U}) = V(\mathcal{U}')$ . Thus there exists  $t' < t$  such that  $z = ul' - t' - 1$ . Since  $t$  is minimum,  $Q(t')$  is true, and thus  $Q(t)$  is true.

If  $c = 1$ , then  $z' = v$  since  $\mathcal{U}$  is entangled with  $\mathcal{V}$ , and  $\beta(uz') = \beta(uv)$ . Let  $z''$  be the vertex just before  $z'$  in  $\mathcal{U}$ . Since  $\beta(uz') = \beta(uv)$ , then  $m(z'') = \beta(uv) \in \beta(\mathcal{V})$ . Since  $m(z) \notin \beta(\mathcal{V})$ , we have that  $z'' \neq z$ . This means that  $z''$  is a vertex in  $V(\mathcal{U}_{>z}) \setminus \{u'\}$  missing a color in  $\beta(\mathcal{V})$ , this is a contradiction.  $\square$

Let  $c \in \beta(\mathcal{V})$ , we prove that  $\mathcal{Z} = X_z(c) = (zz_1, \dots, zz_r)$  is a cycle entangled with  $\mathcal{V}$  and  $\mathcal{U}_{\geq z}$ .

By Claim 5  $m(z) \notin \beta(\mathcal{V})$ , so without loss of generality, we assume that  $z$  is missing the color 4. By Lemma 2.5.18 the fan  $\mathcal{Z}$  is not a path. Before proving that  $\mathcal{Z}$  is not a comet, we first prove that it is entangled with  $\mathcal{V}$  and  $\mathcal{U}_{\geq u_{l-t-2}}$ .

**Proposition 2.5.27.** *The fan  $\mathcal{Z}$  is entangled with  $\mathcal{V}$  and  $\mathcal{U}_{\geq u_{l-t-2}}$ .*

*Proof.* Otherwise, assume that there exists  $s$  such that  $m(z_s) \in \beta(\mathcal{V}) \cup \beta(\mathcal{U}_{\geq z})$  and  $z_s \notin V(\mathcal{V}) \cup V(\mathcal{U}_{\geq z})$ . Without loss of generality, we assume that such an  $s$  is minimum. We also assume that there is no edge colored with a color in  $\beta(\mathcal{V})$  in  $E(\mathcal{Z}_{[z_2, z_{s-1}]})$ . Otherwise, if such an edge  $zz_x$  exists, it suffices to consider the fan  $X_z(\beta(zz_x)) = (zz_x, \dots, zz_s)$ . We now have to distinguish the cases.

*Case 13* ( $m(z_s) = 1$ ).

In this case, since  $P(t)$  is true,  $X_v(4)$  is a saturated cycle containing  $z$ , so  $v \in K_z(1, 4)$ , and thus  $z_s \notin K_z(1, 4)$ . We now swap the component  $C_{1,4} = K_{z_s}(1, 4)$ , and denote by  $\beta'$  the coloring obtained after the swap. In the coloring  $\beta'$ , the fan  $X_z(c)$  is now a path. The coloring  $\beta'$  is  $\mathcal{V}$ -equivalent to  $\beta$ , so  $\mathcal{V}$  is still a minimum cycle in  $\beta'$ . If the coloring  $\beta'$  is also  $\mathcal{U}_{\leq z}$ -equivalent to  $\beta$  (i.e.,  $C_{1,4}$  does not contain  $u$  or there is no edge colored 1 in  $\mathcal{U}_{\leq z}$ ), then  $z$  is still a vertex of  $\mathcal{U} = X_u(3)$ , and the fan  $X_z(c)$  is now a path, by Lemma 2.5.18 this is a contradiction. So the vertex  $u$  belongs to  $C_{1,4}$ , and there is an edge  $uu_h$  colored 1 in  $\mathcal{U}_{<z}$ . So in the coloring  $\beta'$ , the edge  $uu_h$  is now colored 4, and the edge  $u_{l-t}$  is now colored 1. The fan  $X_v(4)$  is still a saturated cycle containing  $z$ , but now the fan  $X_u(4)$  is also a cycle



containing  $z$ . In this coloring the fan  $X_z(c)$  is a path, so by Lemma 2.5.23, we have a contradiction.

*Case 14* ( $m(z_s) = c' \in \beta(\mathcal{V}) \setminus \{1\}$ ).

In this case, since  $\mathcal{V}$  is minimum, it is saturated by Lemma 2.3.4, thus  $z_s \notin K_v(1, c')$ . We now swap the component  $C_{1, c'} = K_{z_s}(1, c')$ , and denote by  $\beta'$  the coloring obtained after the swap. This coloring is  $\mathcal{V}$ -equivalent to  $\beta$ , so  $\mathcal{V}$  is still a minimum cycle in the coloring  $\beta'$ . By Claim 6, there is no edge with a color in  $\beta(\mathcal{V})$  in  $\mathcal{U}_{>z}$ , so  $\beta'$  is  $\mathcal{U}_{>z}$ -equivalent to  $\beta$ . Moreover, let  $\mathcal{U}' = X_u^{\beta'}(3) = (uu'_1, \dots, uu'_t)$ ; the coloring  $\beta'$  is also  $(\bigcup_{j \in [0, t]} X_v(\beta(uu_j)))$ -equivalent to  $\beta$  since

each of these fans are saturated cycles, and the vertex  $z_s$  does not belong to any of them. So by Lemma 2.5.21, in the coloring  $\beta'$ , for any  $j \leq (t+1)$ ,  $u'_{t-j} = u_{t-j}$ . In particular,  $u'_{t-1} = u_{t-1} = z$ . But now  $X_z(c)$  is not entangled with  $\{v\}$  since it contains the vertex  $z_s$  which is missing the color 1. This case is similar to the previous one.

*Case 15* ( $m(z_s) = c' \in \beta(\mathcal{U}_{>z})$ ).

Let  $u_{l-h}$  be the vertex of  $\mathcal{U}_{>z}$  missing the color  $c'$ . In this case, since  $P(j)$  is true for all  $j \leq t$ , the fan  $X_v(\beta(uu_{l-j}))$  is a saturated cycle. In particular, the vertex  $u_{l-h}$  belongs to the component  $K_v(1, c')$ , and so  $z_s$  does not belong to this component. We now swap the component  $C_{1, c'} = K_{z_s}(1, c')$ , and denote by  $\beta'$  the coloring obtained after the swap. Let  $\mathcal{U}' = X_u^{\beta'}(3) = (uu'_1, \dots, uu'_t)$ . If the coloring  $\beta'$  is  $\mathcal{U}_{>z}$ -equivalent to  $\beta$ , then for the same reason as in the previous case,  $z$  is exactly the vertex  $u'_{t-1}$ , and  $X_z(c')$  is now not entangled with  $\{v\}$  since it contains the vertex  $z_s$  that is missing the color 1. This case is similar to the first one. So  $\beta'$  is not  $\mathcal{U}_{>z}$ -equivalent to  $\beta$ , and thus since it is  $\{u_{l-h}\}$ -equivalent to  $\beta$ , the component  $C_{1, c'}$  contains the vertex  $u$ . We now have to distinguish whether or not, in the coloring  $\beta$  there is an edge  $uu_p$  colored 1 in  $\mathcal{U}_{<z}$ .

*Subcase 15.1* (There an edge  $uu_p$  colored 1 in  $\mathcal{U}_{<z}$ ).

In this case, in the coloring  $\beta'$ , the edge  $uu_p$  is now colored  $c'$ , and the edge  $uu_{l-h+1}$  is now colored 1. In the coloring  $\beta'$ , the fan  $X_u(4)$  is now a cycle since it contains the vertex  $u_{l-h}$  which is still missing the color  $c'$ , and  $X_v(c')$  now contains the vertex  $z$  which is still missing the color 4. The fan  $X_v(4)$  is still a cycle containing also the vertex  $z$ , and the fan  $\mathcal{U}'$  now contains an edge  $uu_{l-p}$  colored 1 such that  $p \leq t$ .

We now consider the components of  $K(1, 4)$ . If the vertex  $z$  does not belong to the component  $K_v(1, 4)$ , then we swap it to obtain a coloring  $\beta''$  where  $X_v(4)$  is now a path. Let  $\mathcal{U}'' = X_u^{\beta''}(3) = (uu''_1, \dots, uu''_t)$ . If  $u \notin K_v(1, 4)$ , then  $\beta''(uu_{l-p}) = \beta''(uu''_{t-t}) = 1$ , but  $p \leq t$ , and  $P(j)$  is true for all  $j \leq t$ , so by Lemma 2.5.22 we have a contradiction. Similarly, if  $u \in K_v(1, 4)$ , then now  $\beta''(uu_{l-t}) = 1$ . Since  $\beta''$  is  $(\bigcup_{j \in [0, t-1]} X_v(\beta(uu_j)))$ -equivalent to  $\beta'$ , by Lemma 2.5.21,

for any  $j \leq t$ ,  $u''_{l'-j} = u'_{l'-t}$ . So the edge  $uu_{l-t}$  is exactly the edge  $uu''_{l'-t}$ . This edge is colored 1, and  $P(j)$  is true for all  $j \leq t$ , so by Lemma 2.5.22, we have a contradiction.

So the vertex  $z$  belongs to  $K_v(1, 4)$ , and therefore the vertex  $z_s$  does not belong to this component. We now swap the component  $C_{1,4} = K_{z_s}(1, 4)$ , and denote by  $\beta''$  the coloring obtained after the swap. Let  $\mathcal{U}'' = X_u^{\beta''}(3) = (uu''_1, \dots, uu''_{l'})$ . Whether or not the vertex  $u$  belongs to the component  $C_{1,4}$ , the fan  $X_u(3)$  contains an edge  $uu''_{l'-j}$  colored 1 where  $j \leq t$  (if  $u$  belongs to the component,  $\beta''(uu''_{l'} - t) = 1$ , and  $\beta''(uu''_{l'-p}) = 1$ ). Moreover, we have that the fan  $X_u(4)$  is a cycle containing  $z$ , the fan  $X_v(4)$  is a cycle containing  $z$ , the fan  $X_z(c)$  is a path, and , and the property  $P(j)$  is true for all  $j \leq t$ , so by Lemma 2.5.23, we have a contradiction.

*Subcase 15.2* (There is no edge colored 1 in  $\mathcal{U}_{<z}$ ).

In this case, the coloring  $\beta'$  is  $\mathcal{U}_{\leq z}$ -equivalent to  $\beta$ . We now consider the components of  $K(1, 4)$ . If  $z$  does not belong to  $K_v(1, 4)$ , then we swap the component  $K_z(1, 4)$  and obtain a coloring where  $X_u(3)$  still contains the vertex  $z$  which is now missing the color 1. In the coloring, the cycle  $\mathcal{V}$  is still a minimum cycle since  $\beta'$  is  $\mathcal{V}$ -equivalent to  $\beta$ , so by Lemma 2.3.13, we have a contradiction.

So the vertex  $z$  belongs to  $K_v(1, 4)$ , and thus  $z_s$  does not belong to this component. We now swap the component  $C_{1,4} = K_{z_s}(1, 4)$ , and denote by  $\beta''$  the coloring obtained after the swap. The coloring  $\beta''$  is  $\mathcal{U}_{\leq z}$ -equivalent to  $\beta'$ , so  $z \in X_u(3)$ . However, now the fan  $X_z(c)$  is a path, by Lemma 2.5.18, we have a contradiction.

*Case 16* ( $m(z_s) = c' = m(u_{l-t-2})$ ).

In this case, since  $c' \notin \beta(\mathcal{V})$ , without loss of generality, we assume that  $c' = 5$ . We now consider the components of  $K(1, 5)$ . If  $u_{l-t-2}$  does not belong to  $K_z(4, 5)$ , then we swap the component  $C_{4,5} = K_{u_{l-t-2}}(4, 5)$ , and denote by  $\beta'$  the coloring obtained after the swap. Let  $\mathcal{U}' = X^{\beta'}(3) = (uu'_1, \dots, uu'_l)$ . The coloring  $\beta'$  is  $(\mathcal{V} \cup \mathcal{U}_{>z})$ -equivalent to  $\beta$ , and for any  $j \leq t$ ,  $u'_{l'-j} = u_{l-j}$ , and  $u'_{l'-j} = u_{l-j-1}$  otherwise. Note that this means that  $l' = l - 1$ , i.e.  $|\mathcal{U}'| = |\mathcal{U}| - 1$ . If the color 5 is not in  $X_v^\beta(4)$ , then  $X_v(4)$  is still a cycle containing  $z$ , and thus it does not contain  $u_{l-t-2} = M(X_u(3), 4)$ , since the property  $P(t)$  is true, we have a contradiction.

So the color 5 is in  $X_v^\beta(4)$ . If  $v$  belongs to  $C_{4,5}$ , then we are in a case similar to the previous one where  $X_v^{\beta'}(4)$  is a cycle containing  $z$ , and thus which does not contain  $u_{l-t-2} = M(X_u(3), 4)$ . Since  $P(t)$  is true, we have a contradiction. So  $v$  does not belong to  $C_{4,5}$ , and now, in the coloring  $\beta'$ , the fan  $X_v(5)$  is a comet containing the vertices  $z$  and  $u_{l-t-2}$  that are both missing the color 4. We now consider the components of  $K(1, 4)$ . Since the property  $P(t)$  is true,  $X_v(4)$  is a saturated cycle, so  $u_{l-t-2}$  belongs to  $K_v(1, 4)$ , and thus  $z$  does not belong to

this component. We now swap the component  $K_z(1, 4)$ , and obtain a coloring where  $\{uz\}$  is a  $(\mathcal{V}, u)$ -independent subfan avoiding  $v$ , and where  $X_v(5)$  is a path containing  $z$ , by Lemma 2.5.4 we have a contradiction.

So the vertex  $u_{l-t-2}$  belongs to the component  $K_z(4, 5)$ , and therefore, the vertex  $x_s$  does not belong to this component. We now swap the component  $K_{z_s}(4, 5)$ , to obtain a coloring  $(\mathcal{V} \cup \mathcal{U})$ -equivalent to  $\beta$ , where  $X_z(c)$  is now a path, by Lemma 2.5.18, we again get a contradiction.  $\square$

So the fan  $\mathcal{Z}$  is entangled with  $\mathcal{V}$  and  $\mathcal{U}_{\leq u_{l-t-2}}$ . We now prove that it is not a comet. Assume that  $\mathcal{Z}$  is a comet, then there exists  $h < r$  such that  $m(z_h) = m(z_r) = c$ . By Proposition 2.5.27,  $c \notin \beta(\mathcal{V}) \cup \beta(\mathcal{U}_{\geq u_{l-2-t}})$ . Without loss of generality, we assume that  $c = 5$ , and we now consider the components of  $K(1, 5)$ . The vertices  $z_h$  and  $z_r$  are not both part of  $K_v(1, 5)$ .

If  $z_h$  does not belong to  $K_v(1, 5)$ , then we swap  $C_{1,5} = K_v(1, 5)$ , and denote by  $\beta'$  the coloring obtained after the swap. Let  $\mathcal{U}' = X_u^{\beta'}(3) = (uu'_1, \dots, uu'_l)$ . The property  $P(j)$  is true for all  $j \leq t$ , so the coloring  $\beta'$  is  $(\bigcup_{j \in [0, p]} X_v(\beta(uu_{l-j})))$ -equivalent to  $\beta$  since each of these fans are saturated cycle. Hence by Lemma 2.5.21, for any  $j \leq (t + 1)$ ,  $u'_{l-j} = u_{l-j}$ . In particular,  $z = u'_{l-t-1}$ . If the vertex  $z$  does not belong to  $C_{1,5}$  or  $c \neq 1$ , then the coloring  $\beta'$  is  $\mathcal{Z}_{< z_h}$ -equivalent to  $\beta$ . The fan  $X_z(c)$  now contains the vertex  $z_h$  which is missing the color 1, by Proposition 2.5.27 we have a contradiction. So the vertex  $z$  belongs to  $C_{1,5}$ , and  $c = 1$ . Thus, in the coloring  $\beta'$ , the edge  $zz_1$  is now colored 5, and the edge  $zz_{s+1}$  is now colored 1. If the vertex  $z_r$  belongs to the component  $C_{1,5}$ , it is now missing the color 1 in the coloring  $\beta'$ , and  $X_z(1)$  is now a fan that contains this vertex. So the fan  $X_v(1)$  is not entangled with  $\mathcal{V}$ , a contradiction by Proposition 2.5.27. If the vertex  $z_r$  does not belong to the component, then the fan  $X_z(1)$  now contains the vertex  $z_s$  which is missing the color 1, again, a contradiction by Proposition 2.5.27.

So the vertex  $z_h$  belongs to  $K_v(1, 5)$ , and thus the vertex  $z_r$  does not belong to the component. We now swap the component  $C_{1,5} = K_{z_s}(1, 5)$  and denote by  $\beta'$  the coloring obtained after the swap. Similarly to the previous case, If the vertex  $z$  does not belong to  $C_{1,5}$ , or if  $c \neq 1$ , then the coloring  $\beta'$  is  $\mathcal{Z}_{< z_r}$ -equivalent to the coloring  $\beta$ , and now  $X_z(c)$  contains the vertex  $z_r$  missing the color 1, by Proposition 2.5.27 this is a contradiction. So the vertex  $z$  belongs to  $C_{1,5}$ , and  $c = 1$ . In this case, the fan  $X_z(1)$  stills contains the vertex  $z_r$  which is missing the color 1. Again by Proposition 2.5.27, this is a contradiction.

Therefore, the fan  $\mathcal{Z}$  is a cycle entangled with  $\mathcal{V}$  and  $\mathcal{U}_{\geq u_{l-t-2}}$  and thus  $Q(t)$  is true as desired.  $\square$

We are now ready to prove that  $P(i)$  is true for all  $i$ .

### 2.5.6 Proof of $P(i)$

*Proof of Lemma 2.5.3.* Let  $i \geq 0$ ,  $\mathcal{V}$  be a minimum cycle in a coloring  $\beta$ ,  $u$  and  $u'$  two vertices of  $\mathcal{V}$ ,  $\mathcal{U} = X_u(m(u')) = (uu_1, \dots, uu_i)$ , and assume that  $P(i)$  not verified. Without loss of generality, we assume that  $i$  is minimum, and that the vertices  $v$ ,  $u$  and  $u'$  are respectively missing the colors 1, 2 and 3. By Lemma 2.5.10, the property  $P(0)$  is true, so  $i > 0$ . Assume that  $\beta(uu_{l-i}) \neq 1$  and let  $\mathcal{X} = X_v(\beta(uu_{l-i}))$ .

**Claim 7.** *There is no edge in  $E(\mathcal{U}_{>u_{l-i}})$  colored with a color in  $\beta(\mathcal{V})$*

*Proof.* The proof is similar to the proof of Claim 6 of Lemma 2.5.26.  $\square$

We first prove that  $P_{weak}(i)$  is true (i.e. that  $\mathcal{X}$  is not a path).

**Claim 8.** *The property  $P_{weak}(i)$  is true.*

*Proof.* Assume that  $\beta'(uu_{l-i}) \neq 1$  and that  $\mathcal{X} = X_v(\beta(uu_{l-i}))$  is a path. Then we have that  $\beta(uu_{l-i}) \notin \beta(\mathcal{V})$ . Without loss of generality, we assume that  $\beta(uu_{l-i}) = 4$ . Moreover, we have that  $m(u_{l-i}) \neq 1$ . Since  $P(j)$  is true for all  $j < i$ , for all  $j < i$ , if  $\beta(uu_{l-j}) \neq 1$ , then  $X_u(\beta(uu_{l-j}))$  is a saturated cycle. We now invert  $\mathcal{X}$  until we reach a coloring where  $X_v(4)$  is a path of length 1; we denote by  $z$  the only vertex of this coloring. Up to a relabeling of the colors, we assume that  $v$  is also missing the color 1 in  $\beta'$ . The coloring  $\beta'$  is  $\mathcal{V}$ -equivalent to the coloring  $\beta$ , so  $\mathcal{V}$  is the same minimum cycle in the coloring  $\beta$ . So by Lemma 2.3.13 the fan  $\mathcal{U}' = X_u(m(u')) = (uu'_1, \dots, uu'_i)$  is a cycle entangled with  $\mathcal{V}$ . Moreover, the coloring  $\beta'$  is  $(\bigcup_{j < i} X_v(\beta(uu_{l-j})))$ -equivalent to  $\beta$ , so by

Lemma 2.5.21, for any  $j \leq i$ ,  $u'_{l-j} = u_{l-j}$ , the fan  $X_v(\beta'(uu'_{l-j}))$  is a saturated cycle containing  $u'_{l-j-1}$ . So in particular,  $uu'_{l-i} \in E(\mathcal{U}')$ , and there is a vertex missing the color 4 in  $\mathcal{U}'$ . Let  $z'$  be this vertex. Note that since  $X_v(4)$  is a path, for all  $j < i$ ,  $X_v(\beta'(uu'_{l-j}))$  does not contain the vertex  $z'$ .

We now swap the edge  $vz$ , and denote by  $\beta''$  the coloring obtained after the swap. If the coloring  $\beta''$  is  $\mathcal{U}'$ -equivalent to  $\beta'$ , then it means that  $v \notin V(\mathcal{U}')$ . So in the coloring  $\beta''$  the fan  $X_u(3) = \mathcal{U}'$  contains the vertex  $z'$  which is still missing the color 4. This color is also the missing color of the vertex  $v$ . Thus,  $\mathcal{U}'$  is not entangled with  $\mathcal{V}$ , and by Lemma 2.3.13, we have a contradiction.

So the vertex  $v$  belongs to  $V(\mathcal{U}')$ , and in the coloring  $\beta'$ , the fan  $X_u(1)$  contains the vertex  $z'$  which is missing the color 4. If there is an edge  $uu''$  of  $E(V_u(1)_{\leq z'})$  colored with a color of  $\beta''$ , then  $X_u(\beta''(uu''))$  is not entangled with  $\mathcal{V}$ , so by Lemma 2.3.13, we have a contradiction. Therefore, the subfan  $X_u(1)_{\leq z'}$  is a  $(\mathcal{V}, u)$ -independent subfan avoiding  $v$ . The coloring  $\beta''$  is  $\mathcal{U}'_{\leq v}$ -equivalent to the coloring  $\beta'$ , so in the coloring  $\beta''$ , the fan  $\mathcal{U}'' = X_u(3)$  is equal to  $(uu'_1, \dots, uv, uu'_{l-i}, \dots, uu'_i = uu')$ .

Since  $P(j)$  is true for all  $j < i$ , for all  $j < i$  the fan  $X_v(\beta''(uu'_{i-j}))$  is a saturated cycle containing  $u'_{i-j-1}$ . In particular, the fan  $X_v(\beta''(uu'_{i-(i-1)}))$  is a saturated cycle containing  $u'_{i-1}$ . Without loss of generality, we assume that  $m(u'_{i-1}) = 5$ . The vertex  $u'_{i-1}$  belongs to the component  $K_v(4, 5)$ , so the vertex  $z'$  does not belong to this component. We now swap the component  $C_{4,5} = K_{z'}(4, 5)$ , and denote by  $\beta_3$  the coloring obtained after the swap. Note that  $\beta_3$  is  $\mathcal{V}$ -equivalent to  $\beta''$ , so by Observation 2.3.9 the cycle  $\mathcal{V}$  is the same minimum cycle in the coloring  $\beta_3$ . The coloring  $\beta_3$  is also  $\mathcal{U}''$ -equivalent to  $\beta''$ , so we still have that  $X_u(3) = (uu'_1, \dots, uv, uu'_{i-1}, \dots, uu'_i = uu')$ .

If the vertex  $z$  does not belong to  $C_{4,5}$ , then we can swap back the edge  $uz$ . The fan  $X_u(3) = X_u(1)$  still contains the vertex  $z'$  which is missing the color 5, and  $X_v(\beta''(uu'_{i-1}))$  is still a saturated cycle containing the vertex  $u'_{i-1}$ . Since  $P(i-1)$  is true, we have a contradiction. So the vertex  $z$  belongs to  $C_{4,5}$ , and in the coloring  $\beta_3$  the vertex  $z$  is missing the color 5.

Since the property  $P(j)$  is true for all  $j < i$ , by Lemma 2.5.26, the property  $Q(i-1)$  is true, and so the fan  $X_{u'_{i-1}}(2)$  is a cycle containing  $z'$ , and therefore there is an edge  $u'_{i-1}z'$ . We denote by  $c'$  the color of this edge. We now swap this edge, and denote by  $\beta_4$  the coloring obtained after the swap. The coloring  $\beta_4$  is  $\mathcal{V}$ -equivalent to  $\beta_3$ , so the fan  $\mathcal{V}$  is the same minimum cycle in the coloring  $\beta_4$  by Observation 2.3.9. The coloring  $\beta_4$  is also  $X_u(3)_{<u'_{i-1}}$ , so the vertex  $u'_{i-1}$  is still in  $X_u(3)$ . Note that now the vertex  $u'_{i-1}$  and  $z'$  are both missing the color  $c'$ . We now have to distinguish the case.

*Case 17* ( $c' = 1$ ).

In this case, the fan  $X_u(1)$  contains the vertex  $z'$  missing the color 1, and the fan  $X_u(3)$  contains the vertex  $u'_{i-1}$  missing the color 1. So the fan  $X_u(3)$  is a comet containing two vertices missing the color 1, so by Lemma 2.3.13, we have a contradiction.

*Case 18* ( $c' \in \beta_3(\mathcal{V})$ ).

In this case, since  $u'_{i-1} \in V(X_u(3))$ , the fan  $X_u(3)$  is not entangled with  $\mathcal{V}$ , so by Lemma 2.3.13, we have a contradiction.

Without loss of generality, we now assume that  $c' = 6$ .

*Case 19* ( $6 \in \beta_3(X_u(3)_{<u'_{i-1}})$ ).

In this case, the fan  $X_u(3)$  is now a comet where two vertices are missing the color 6, thus by Lemma 2.3.13, we also have a contradiction.

*Case 20* ( $6 \in \beta_3(X_u(3)_{>u'_{i-1}})$ ).

Let  $t < i$  such that  $m^{\beta_3}(u'_{i-t}) = 6$ . Since  $P(t-1)$  is true, in the coloring  $\beta_3$ , the fan  $X_v(6)$  is a cycle containing  $u'_{i-t}$ . Since  $P(i-1)$  is true, the fan  $X_v(5)$  is a cycle containing  $u'_{i-1}$ . We first prove that in the coloring  $\beta_3$ , we have  $X_v(5) = X_v(6)$ . In the coloring  $\beta_4$ , the vertex  $u'_{i-1}$  is missing the color 6, so the fan  $X_u(3)$  is

equal to  $(uu'_1, \dots, uv, uu'_{l'-i}, uu'_{l'-(t-1)}, \dots, uu'_{l'} = uu')$ , and  $u'_{l'-i}$  is now the vertex missing the color 6 in this cycle. Since  $P(t-1)$  is true, the fan  $X_v(6)$  is now a cycle containing  $u'_{l'-i}$ . The only vertices whose missing color is different in  $\beta_3$  and  $\beta_4$  are the vertices  $u'_{l'-i}$  and  $z'$ . In the coloring  $\beta_3$ , since  $z' \notin X_v(6)$ , if  $u'_{l'-i} \notin V(X_v(6))$  the coloring  $\beta_4$  is  $X_v(6)$ -equivalent to the coloring  $\beta_3$ . This means that in the coloring  $\beta_4$ , the fan  $X_v(6)$  is a cycle containing the vertex  $u'_{l'-t}$ , and not containing  $u'_{l'-i}$ , a contradiction. So in the coloring  $\beta_3$ , the vertex  $u'_{l'-i}$  belongs to  $X_v(6)$ , and thus  $X_v(5) = X_v(6)$  as desired.

So, in the coloring  $\beta_3$ , the cycle  $X_v(5)$  contains the vertex  $u'_{l'-t}$  which is missing the color 6. We now consider the coloring  $\beta_4$ . The fan  $X_v(5)$  still contains the vertex  $u'_{l'-t}$  which is still missing the color 6. The fan  $X_v(6)$  is a saturated cycle containing the vertex  $u'_{l'-i}$ , so the fan  $X_v(5)$  is a comet containing  $X_v(6)$  as a subfan. The cycle  $X_v(6)$  is saturated, so  $u'_{l'-i}$  belongs to  $K_v(4, 6)$ , and thus  $z'$  does not belong to this component.

We now swap the component  $C_{4,6} = K_{z'}(4, 6)$ , and denote by  $\beta_5$  the coloring obtained after the swap. The coloring  $\beta_5$  is  $\mathcal{V}$ -equivalent to  $\beta_4$ , so the fan  $\mathcal{V}$  is the same minimum cycle in the coloring  $\beta_5$ . Since the vertex  $u'_{l'-i} \notin C_{4,6}$ , and  $\beta_4(uu'_{l'-}) = 4$ , the vertex  $u$  does not belong either to  $C_{4,6}$ , and therefore the coloring  $\beta_5$  is  $X_u(3)$ -equivalent to the coloring  $\beta_4$ . The fan  $X_u(1)$  still contains the vertex  $z'$  which is now missing the color 4, so the subfan  $X_u(1)_{\leq z'}$  is a  $(\mathcal{V}, u)$ -independent subfan avoiding  $v$ . By Lemma 2.5.4, the fan  $X_v(1)$  is a path that does not contain  $z'$ . In the coloring  $\beta_5$ , the vertex  $z$  is still missing the color 5, and we still have  $\beta_5(vz) = 1$ . If the vertex  $u'_{l'-t}$  does to belong to  $C_{4,6}$ , then the coloring  $\beta_5$  is  $X_v(5)$ -equivalent to  $\beta_4$ , and therefore the fan  $X_v(1)$  is a comet containing  $X_v(6)$  as a subfan. So the vertex  $u'_{l'-t}$  belongs to the component  $C_{4,6}$ , and it is now missing the color 4.

In the coloring  $\beta_5$ , the fan  $X_u(5)$  still contains the vertex  $u'_{l'-t}$  which is now missing the color 4. So there is no edge  $uu''$  in  $E(X_u(5)_{\leq u'_{l'-t}})$  colored with a color in  $\beta_5(\mathcal{V})$ , otherwise,  $X_u(\beta_5(uu''))$  is not entangled with  $\mathcal{V}$ , and by Lemma 2.3.13 we have a contradiction. So the subfan  $X_u(5)_{\leq u'_{l'-t}}$  is a  $(\mathcal{V}, u)$ -independent subfan avoiding  $v$ . By Lemma 2.5.4, the fan  $X_v(5)$  is a path that does not contain  $u'_{l'-t}$ , a contradiction.

*Case 21* ( $6 \notin \beta_3(X_u(3)) \cap \beta_3(\mathcal{V}) \cup \{1\}$ ).

In the coloring  $\beta_4$ , the vertex  $u'_{l'-i}$  is missing the color 6, and  $uu'_{l'-i} \in E(X_u(3))$ . So we have  $X_u(6) = X_u(3)$ . Since the fan  $X_u(5)$  also contains the vertex  $u'$ , either  $X_u(5) = X_u(6) = X_u(3)$ , or  $X_u(5)$  is a comet which contains  $X_u(3)$  as a subfan.

*Subcase 21.1* ( $X_u(5) = X_u(3)$ ).

Let  $z''$  be the vertex of  $X_u(3)$  missing the color 5. Note that we may have  $z'' = z$ . Since  $P(i-1)$  is true, the fan  $X_v(5)$  is now a cycle containing  $z''$ . But  $u'_{l'-i}$  is

the only vertex whose missing color is different in  $\beta_3$  and  $\beta_4$ , so in the coloring  $\beta_4$ , the fan  $X_v(5)$  still contains the vertex  $u'_{v-i}$  which is now missing the color 6. Therefore, the fan  $X_v(6)$  is equal to the fan  $X_v(5)$  and is a saturated cycle containing  $z''$  and  $u'_{v-i}$ . The vertex  $z$  is still missing the color 5, so the fan  $X_v(1)$  is now a comet containing  $X_v(5)$  as a subfan.

Since the fan  $X_v(6)$  is saturated, the vertex  $u'_{v-i}$  belongs to the component  $K_v(4, 6)$ , and thus the vertex  $z'$  does not belong to this component. We now swap the component  $C_{4,6} = K_{z'}(4, 6)$ , and denote by  $\beta_5$  the coloring obtained after the swap. The coloring  $\beta_5$  is  $\mathcal{V}$ -equivalent to  $\beta_4$ , so the fan  $\mathcal{V}$  is a minimum cycle in this coloring. Now the fan  $X_u(1)$  still contains the vertex  $z'$  which is now missing the color 4, so it is a  $(\mathcal{V}, u)$ -independent subfan avoiding  $v$  so by Lemma 2.5.4, the fan  $X_v(1)$  is a path. But the coloring  $\beta_5$  is also  $X_v(1)$ -equivalent to the coloring  $\beta_4$ , so the fan  $X_v(1)$  is a comet. This is a contradiction.

*Subcase 21.2* ( $X_u(5)$  is a comet containing  $X_u(3)$ ).

Let  $u'_{v-t}$  be the first vertex of  $X_u(5)$  which is not in  $X_u(3)$ , and let  $z''$  be the vertex of  $X_u(3)$  missing the color  $c_t = m(u'_{v-t})$ . In the coloring  $\beta_3$ , since  $P(t-1)$  is true, the fan  $X_v(c_t)$  is a saturated cycle containing  $u'_{v-t}$ . If the coloring  $\beta_4$  is  $X_v(c_t)$ -equivalent to the coloring  $\beta_3$ , then in the coloring  $\beta_4$  the fan  $X_v(c_t)$  still contains the vertex  $u'_{v-t}$ , and thus does not contain the vertex  $z''$ . Since  $P(t-1)$  is true, we have a contradiction.

So the coloring  $\beta_4$  is not  $X_v(c_t)$ -equivalent to the coloring  $\beta_3$ . Since  $u'_{v-i}$  and  $z'$  are the only vertices whose missing color are different in  $\beta_3$  and  $\beta_4$ , and  $z' \notin V(X_v(c_t))$ , we have that  $u'_{v-i} \in V(X_v(c_t))$ . In the coloring  $\beta_3$  the vertex  $u'_{v-i}$  is also in  $X_v(5)$ , so in this coloring we have  $X_v(5) = X_v(c_t)$ . Therefore, the vertex  $u'_{v-t}$  also belongs to  $X_v(5)$  in the coloring  $\beta_4$ .

In the coloring  $\beta_4$ , the vertex  $u'_{v-i}$  is now missing the color 6, and since  $P(t-1)$  is true, the fan  $X_v(c_t)$  is a saturated cycle containing the vertex  $z''$ . So in this coloring, we have  $X_v(c_t) = X_v(6)$ . However, in this coloring, the vertex  $u'_{v-t}$  still belongs to  $X_v(5)$ , it also belongs to  $X_u(5)$  and is still missing the color  $c_t$ . The cycle  $X_v(c_t)$  is saturated, so the vertex  $z''$  belongs to the component  $K_v(4, c_t)$ , and thus the vertex  $u'_{v-t}$  does not belong to this component. We now swap the component  $K_{u'_{v-t}}(4, c_t)$  and denote by  $\beta_5$  the coloring obtained after the swap.

The coloring  $\beta_5$  is  $\mathcal{V}$ -equivalent to  $\beta_4$ , so by Observation 2.3.9, the fan  $\mathcal{V}$  is a minimum cycle in the coloring  $\beta_5$ . The coloring  $\beta_5$  is also  $((X_u(5) \cup X_v(5)) \setminus \{u'_{v-t}\})$ -equivalent to the coloring  $\beta_4$ , so the vertex  $u'_{v-t}$  still belongs to both  $X_u(5)$  and  $X_v(5)$ . So the subfan  $X_u(5)_{\leq u'_{v-t}}$  is a  $(\mathcal{V}, u)$ -independent subfan avoiding  $v$ , by Lemma 2.5.4, the fan  $X_v(5)$  is a path that does not contain  $u'_{v-t}$ . Again we have a contradiction.

□

By the previous claim, we have that  $\mathcal{X}$  is not a path, we now prove that it is not a comet. Assume that  $\mathcal{X} = (vx_1, \dots, vx_t)$  is a comet where  $x_s$  and  $x_t$  are missing the same color  $c_s$ . Since  $x_s$  and  $x_t$  are both missing the color  $c_s$  at least one of them is not in  $K_v(1, c_s)$ . Since  $P(j)$  is true for all  $j < i$ , for all  $j < i$ , if  $\beta(uu_{l-j}) \neq 1$ , then  $X_v(\beta(uu_{l-j}))$  is a cycle, so  $\beta(\mathcal{X}) \cap (\bigcup_{j \in [0, i-1]} X_v(\beta(uu_{l-j}))) = \emptyset$ .

*Case 22* ( $c_s \notin \beta(\mathcal{U}_{u_{>l-1}})$ ).

If  $x_s$  is not in  $K_v(1, c_s)$ , then we swap the component  $C_{1, c_s} = K_{x_s}(1, c_s)$  and obtain a coloring  $\beta'$  which is  $\mathcal{V}$ -equivalent to  $\beta$ , so the fan  $\mathcal{V}$  is the same minimum cycle in the coloring  $\beta'$ . In the coloring  $\beta'$ , the fan  $X_v(4)$  is now a path. Moreover,  $c_s \notin \beta(\mathcal{U}_{\geq u_{l-i}})$ , and by Claim 7, so  $1 \notin \beta(\mathcal{U}_{\geq u_{l-i}})$ . Therefore, the coloring  $\beta'$  is  $\mathcal{U}_{\geq u_{l-i}}$ -equivalent to the coloring  $\beta$ . Let  $\mathcal{U}' = X_u^{\beta'}(3) = (uu'_1, \dots, uu'_l)$ . Since  $\beta(\mathcal{X}) \cap (\bigcup_{j \in [0, i-1]} X_v(\beta(uu_{l-j}))) = \emptyset$ , the coloring  $\beta'$  is  $(\bigcup_{j \in [0, i-1]} X_v(\beta(uu_{l-j})))$ -equivalent to  $\beta$ . So by Lemma 2.5.21, for all  $j \leq i$ , we have  $u'_{l-i} = u_{l-i}$ . In particular  $u'_{l-i} = u_{l-i}$ . Since  $\beta'(uu'_{l-i}) = 4$ , and  $P_{weak}(i)$  is true, the fan  $X_v(4)$  is not a path.

Similarly, if  $x_t \notin K_v(1, c_s)$ , we swap the component  $C_{1, c_s} = K_{x_t}(1, c_s)$ . Note that  $\mathcal{V}$  is a minimum cycle, so it is saturated by Lemma 2.3.4, and thus  $x_t \notin V(\mathcal{V})$ . The coloring  $\beta'$  is therefore  $\mathcal{V}$ -equivalent to  $\mathcal{V}$ , so the fan  $\mathcal{V}$  is the same minimum cycle in this coloring. The fan  $X_v(4)$  is now a path the coloring  $\beta'$ . Let  $\mathcal{U}' = X_u^{\beta'}(3) = (uu'_1, \dots, uu'_l)$ . Similarly to the previous case, the coloring  $\beta'$  is  $\mathcal{U}_{>u_{l-i}}$ -equivalent to  $\beta$  and  $(\bigcup_{j \in [0, i-1]} X_v(\beta(uu_{l-j})))$ -equivalent to  $\beta$ . So by Lemma 2.5.21, for all  $j \leq i$ , we have  $u'_{l-j} = u_{l-j}$ . In particular,  $u'_{l-i} = u_{l-i}$ , and  $\beta'(uu'_{l-i}) = 4$ . Since  $P_{weak}(i)$  is true, the fan  $X_v(4)$  is not a path, a contradiction.

*Case 23* ( $c_s \in \beta(\mathcal{U}_{>u_{l-1}})$ ).

Let  $t'$  be such that  $m(u_{l-t'}) = c_s$ . Since  $P(j)$  is true for all  $j < i$ , the fan  $X_v(c_s)$  is saturated cycle containing  $u_{l-t'} = x_t$ . So the vertex  $x_s$  does not belong to  $K_v(1, c_s)$ . We now swap the component  $C_{1, c_s} = K_{x_s}(1, c_s)$  to obtain a coloring  $\beta'$  where  $X_v(4)$  is now a path. The coloring  $\beta'$  is  $\mathcal{V}$ -equivalent to  $\beta$ , so by Observation 2.3.9, the cycle  $\mathcal{V}$  is the same minimum cycle in the coloring  $\beta'$ . If the vertex  $u$  does not belong to  $C_{1, c_s}$ , then the coloring  $\beta'$  is also  $\mathcal{U}$ -equivalent to  $\beta$ , and thus  $X_u(3) = \mathcal{U}$ . Since  $\beta'(uu_{l-i}) = 4$ , and  $P_{weak}(i)$  is true, the fan  $X_v(4)$  is not a path. this is a contradiction.

So the vertex  $u$  belongs to  $C_{1, c_s}$ , and in the coloring  $\beta'$ , the edge  $uu_{l-(t'-1)}$  is now colored 1. Let  $\mathcal{U}' = X_u^{\beta'}(3)$ . The coloring  $\beta'$  is  $\mathcal{U}_{>u_{l-t'}}$ -equivalent to  $\beta$ . The coloring  $\beta'$  is also  $(\bigcup_{j \in [0, t'-1]} X_v(\beta(uu_{l-j})))$ -equivalent to  $\beta$ , so by Lemma 2.5.21, for any  $j \leq t'$  we have  $u'_{l-j} = u_{l-j}$ . In particular,  $u'_{l-(t'-1)} = u_{l-(t'-1)}$ . Now the



## 2. Vizing's edge-coloring conjecture

---

edge  $uu'_{t-(t'-1)}$  is colored 1, and the fan  $X_v(4)$  is a path. Since  $P(j)$  is true for all  $j \leq t'$ , by Lemma 2.5.22 there is not path around  $v$ , a contradiction.

So the fan  $\mathcal{X} = (vx_1, \dots, vx_t)$  is a cycle, we now prove that it is saturated. Otherwise, there exists  $x_s$  such that  $x_s \notin K_v(1, m(x_s))$ . Note that since  $P(j)$  is true for all  $j < i$ , for all  $j < i$ , the fan  $X_v(\beta(uu_{l-j}))$  is a saturated cycle, so  $X_v(\beta(uu_{l-j})) \cap \beta(\mathcal{X}) = \emptyset$ , and in particular  $x_s \notin \beta(\mathcal{U}_{>u_{l-i}})$ .

*Case 24* ( $m(x_s) \neq 4$ ).

Without loss of generality, assume that  $m(x_s) = 5$ . Since  $x_s$  does not belong to  $K_v(1, 5)$ , we swap the component  $C_{1,5} = K_{x_s}(1, 5)$  and obtain a coloring  $\beta'$  where  $X_v(4)$  is a path. The coloring  $\beta'$  is  $\mathcal{V}$ -equivalent to  $\beta$ , so by Observation 2.3.9, the cycle  $\mathcal{V}$  is the same minimum cycle in the coloring  $\beta'$ . Let  $\mathcal{U}' = X_u^{\beta'}(3) = (uu'_1, \dots, uu'_t)$ . Moreover,  $5 \notin \beta(\mathcal{U}_{\geq u_{l-i}})$ , and by Claim 7, the color 1 does not appear either in  $\mathcal{U}_{>u_{l-i}}$ . The coloring  $\beta'$  is also  $(\bigcup_{j \in [0, i-1]} X_v(\beta(uu_{l-j}))$ -equivalent to  $\beta$ , so by Lemma 2.5.21, for any  $j \leq i$ , we have  $u'_{l-j} = u_{l-j}$ . In particular,  $u'_{l-i} = u_{l-i}$ . The edge  $uu'_{l-i}$  is still colored 4 in the coloring  $\beta'$  and the property  $P_{weak}(i)$  is true, so  $X_v(4)$  is not a path, a contradiction.

*Case 25* ( $m(x_s) = 4$ ).

In this case, we swap the component  $C_{1,4} = K_{x_s}(1, 4)$  and denote by  $\beta'$  the coloring obtained after the swap. If the vertex  $u$  does not belong to this component, then we are in a coloring similar to the previous case. So the vertex  $u$  belongs to  $C_{1,4}$ , and we have  $\beta'(uu_{l-i}) = 1$ . In the coloring  $\beta'$  is  $\mathcal{V}$ -equivalent to  $\beta$ , so by Observation 2.3.9, the cycle  $\mathcal{V}$  is the same minimum cycle in this coloring. The fan  $X_v(4)$  is now a path in the coloring  $\beta'$ . Let  $\mathcal{U}' = X_u^{\beta'}(3) = (uu'_1, \dots, uu'_t)$ . The coloring  $\beta'$  is  $\mathcal{U}_{>u_{l-i}}$ -equivalent to  $\beta$ , and is also  $(\bigcup_{j \in [0, i-1]} X_v(\beta(uu_{l-j}))$ -equivalent to  $\beta$ . So by Lemma 2.5.21 for all  $j \leq i$ , we have  $u'_{l-j} = u_{l-j}$ . In particular  $u'_{l-i} = u_{l-i}$ . The property  $P(j)$  is true for all  $j < i$ , and  $P_{weak}(i)$  is also true, so by Lemma 2.5.22 there is no path around  $v$ . This is a contradiction.

So the fan  $\mathcal{X} = (vx_1, \dots, vx_t)$  is a saturated cycle, and thus  $x_t \in K_v(1, 4)$ . Since  $P(i)$  is false, we have  $x_t \neq u_{l-i-1}$ . So the vertex  $u_{l-i-1}$  which is also missing the color 4 does not belong to  $K_v(1, 4)$ . We now swap the component  $C_{1,4} = K_{u_{l-i-1}}(1, 4)$  and denote by  $\beta'$  the coloring obtained after the swap. Be Lemma 2.5.20, the vertex  $u$  belongs to  $C_{1,4}$ , there is an edge  $uu''$  colored 1 in  $\mathcal{U}_{<u_{l-i}}$ , and the subfan  $X_u(1)_{\leq u_{l-i}}$  is a  $(\mathcal{V}, u)$ -independent subfan. So in the coloring  $\beta'$ , the vertex  $u_{l-i}$  is now missing the color 1, the edge  $uu''$  is now colored 4, and the subfan  $X_u(4)_{\leq u_{l-i}}$  is a  $(\mathcal{V}, u)$ -independent subfan avoiding  $v$ . By Lemma 2.5.4, the fan  $X_v(4)$  is a path. However, the coloring  $\beta'$  is  $X_v(4)$ -equivalent to the coloring  $\beta$ , so the fan  $X_v(4)$  is a cycle, a contradiction.  $\square$

## 2.6 Cycles interactions

In this section we prove Lemma 2.3.12.

*Proof.* We first prove that all the three cycles are tight and saturated.

**Claim 9.** *The cycles  $\mathcal{V}$ ,  $\mathcal{X}$ , and  $\mathcal{Y}$  are saturated and tight.*

*Proof.* As the fan  $\mathcal{V}$  is not invertible, it is saturated by Lemma 2.1.10. If  $\mathcal{X}$  or  $\mathcal{Y}$  is not saturated, without loss of generality, we assume that  $\mathcal{X}$  is not saturated. Then we swap a component  $K_u(c_v, c_u)$  with  $u$  in  $\mathcal{X}$  and  $u \notin K_v(c_v, c_u)$  to transform  $\beta$  into a coloring where  $\mathcal{V}$  is still a cycle of the same size, and where a fan around  $v$  is a path, by Lemma 2.3.11,  $\mathcal{V}$  is invertible in this coloring, and so it is in the original coloring. Similarly, assume that  $\mathcal{X}$  or  $\mathcal{Y}$  is not tight, without loss of generality, we can assume that  $\mathcal{X}$  is not tight. Then we can find two consecutive vertices of  $\mathcal{X}$ ,  $u_i$ , and  $u_{i-1}$  such that the component  $K_{u_{i-1}}(m(u_i), m(u_{i-1}))$  does not contain  $u_i$ . If we swap this component, we obtain a coloring where  $\mathcal{V}$  is still a cycle of the same size, and where a fan around  $v$  is a comet, again by Lemma 2.3.11,  $\mathcal{V}$  is invertible in this coloring, and so it is in the coloring  $\beta$ .  $\square$

By Lemma 2.3.13, we already have that if  $(z, z') \in \mathcal{V}^2$ , then  $X_z(c_{z'})$  is a cycle containing  $z'$ , so we now assume that  $(z, z')$  is not in  $\mathcal{V}^2$ .

**Claim 10.** *The fan  $\mathcal{Z}$  is not a path.*

*Proof.* As  $\mathcal{Z}$  is a path, we invert it until we reach a coloring where  $m(z) \in (\beta(\mathcal{V}) \cup \beta(\mathcal{X}) \cup \beta(\mathcal{Y})) \setminus \{m_\beta(z)\}$ . In this coloring, the fan  $\mathcal{V}$  is still a cycle of the same size, and, there is a fan around  $v$  which is either a path or a comet, by Lemma 2.3.11, this is a contradiction.  $\square$

**Claim 11.** *The fan  $\mathcal{Z}$  is entangled with  $\mathcal{V}$ ,  $\mathcal{X}$ , and  $\mathcal{Y}$ .*

*Proof.* Let us assume that there exists  $z'' \in \mathcal{Z} \setminus (\mathcal{V} \cup \mathcal{Y} \cup \mathcal{X})$  with  $m(z'') \in (\beta(\mathcal{V}) \cup \beta(\mathcal{Y}) \cup \beta(\mathcal{X})) \setminus \{c_z\}$ . If  $m(z'') = c_v$ , since the cycles are saturated by Claim 9,  $K_{z''}(c_z, c_v)$  does not contain any vertex of  $(\mathcal{V} \cup \mathcal{Y} \cup \mathcal{X})$ , and after swapping it, we obtain a coloring where  $\mathcal{V}$  is still a cycle of the same size and where  $\mathcal{Z}$  is a path, by Claim 10, this is a contradiction. If  $m(z'') \neq c_v$ , then, since the cycles are saturated, the component  $K_{z''}(c_v, m(z''))$  does not contain any vertex of  $(\mathcal{V} \cup \mathcal{Y} \cup \mathcal{X})$ , so if we swap it, we obtain a coloring which corresponds to the previous case.  $\square$

**Claim 12.** *The fan  $\mathcal{Z}$  is not a comet.*

## 2. Vizing's edge-coloring conjecture

---

*Proof.* Assume that  $\mathcal{Z}$  is a comet, then there exist  $z_1$  and  $z_2$  with  $m(z_1) = m(z_2) = c$ . By the previous claim, we have that  $c \notin (\beta(\mathcal{V}) \cup \beta(\mathcal{X}) \cup \beta(\mathcal{Y}))$ , otherwise,  $\mathcal{Z}$  is not entangled with one of these cycles. Hence, the component  $K_z(c, m(z))$  either contains  $z_1$  or  $z_2$ , and without loss of generality we can assume that  $z_1 \notin K_z(c, m(z))$ . If we swap  $K_{z_1}(c, m(z))$  we obtain a coloring where no edge of  $(\mathcal{V} \cup \mathcal{X} \cup \mathcal{Y})$  has changed and where  $\mathcal{Z}$  is a path, by Claim 10 this is a contradiction.  $\square$

By the previous claims,  $\mathcal{Z}$  is a cycle, and as it is entangled with the three other cycles, it contains  $z'$ ; this concludes the proof.  $\square$



# Chapter 3

## Other reconfiguration problems

In this chapter, we present our work two other reconfiguration problems. The first one is the reconfiguration version of the Hadwiger's conjecture discussed in Section 3.1, this is joint work with Marthe Bonamy, Clément Legrand-Duchesne and Marc Heinrich [BHLDN21]; this work has been submitted to the Journal of Combinatorial Theory Series B, and is still under review. The authors of this work thank Vincent Delecroix for helpful discussions. The second one is about connected greedy edge-coloring, this is joint work with Marthe Bonamy, Carole Muller, Jakub Pekarek and Alexandra Wesolek [BGM<sup>+</sup>21]; this work has been published in Discrete Applied Mathematics.

### 3.1 A reconfiguration version of Hadwiger's conjecture

#### 3.1.1 Introduction

As discussed in Section 1.4, in the setting of [planar graphs](#), Meyniel proved in 1978 [Mey78] that all 5-colorings form a unique Kempe equivalence class. The result was then extended to all  $K_5$ -minor-free graphs in 1979 by Las Vergnas and Meyniel [LVM81]. They conjectured the following, which can be seen as a reconfiguration counterpoint to Hadwiger's conjecture, though it neither implies it nor is implied by it.

**Conjecture 3.1.1** (Conjecture A in [LVM81]). *For every  $t$ , all the  $t$ -colorings of a graph with no  $K_t$ -minor form a single equivalence class.*

They also proposed a related conjecture that is weaker assuming Hadwiger's conjecture holds.

**Conjecture 3.1.2** (Conjecture A' in [LVM81]). *For every  $t$  and every graph with no  $K_t$ -minor, every equivalence class of  $t$ -colorings contains some  $(t - 1)$ -coloring.*

Here, we disprove both Conjectures 3.1.1 and 3.1.2, as follows.

**Theorem 3.1.3.** *For every  $\varepsilon > 0$  and for any large enough  $t$ , there is a graph with no  $K_t$ -minor, whose  $(\frac{3}{2} - \varepsilon)t$ -colorings are not all Kempe equivalent.*

In fact, we prove that for every  $\varepsilon > 0$  and for any large enough  $t$ , there is a graph that does not admit a  $K_t$ -minor but admits a  $(\frac{3}{2} - \varepsilon)t$ -coloring that is **frozen**; Any pair of colors induce a connected component, so that no Kempe change can modify the color partition. To obtain Theorem 3.1.3, we then argue that the graph admits a coloring with a different color partition. The notion of frozen  $k$ -coloring is related to the notion of *quasi- $K_p$ -minor*, introduced in [LVM81]. A graph  $G$  admits a  $K_p$ -minor if it admits  $p$  non-empty, pairwise disjoint and connected *bags*  $B_1, \dots, B_p \subset V(G)$  such that for any  $i \neq j$ , there is an edge between some vertex in  $B_i$  and some vertex in  $B_j$ . For the notion of quasi- $K_p$ -minor, we drop the restriction that each  $B_i$  should induce a **connected** subgraph of  $G$ , and replace it with the condition that for any  $i \neq j$ , the set  $B_i \cup B_j$  induces a connected subgraph of  $G$ . If the graph  $G$  admits a frozen  $p$ -coloring, then it trivially admits a quasi- $K_p$ -minor<sup>1</sup>, while the converse may not be true. If all  $p$ -colorings of a graph form a single equivalence class, then either there is no frozen  $p$ -coloring or there is a unique  $p$ -coloring of the graph up to color permutation. The latter situation in a graph with no  $K_p$ -minor would disprove Hadwiger's conjecture, so Las Vergnas and Meyniel conjectured that there is no frozen  $p$ -coloring in that case. Namely, they conjectured the following.

**Conjecture 3.1.4** (Conjecture C in [LVM81]). *For any  $t$ , any graph that admits a quasi- $K_t$ -minor admits a  $K_t$ -minor.*

Conjecture 3.1.4 is known to hold for  $t \leq 10$  [Kri21]. As discussed above, we strongly disprove Conjecture 3.1.4 for large  $t$ . It is unclear how large  $t$  needs to be for a counter-example.

**Theorem 3.1.5.** *For every  $\varepsilon > 0$  and for any large enough  $t$ , there is a graph that admits a quasi- $K_t$ -minor but does not admit a  $K_{(\frac{2}{3} + \varepsilon)t}$ -minor.*

Trivially, every graph that admits a quasi- $K_{2t}$ -minor admits a  $K_t$ -minor. We leave the following two open questions, noting that  $\frac{2}{3} \geq c \geq \frac{1}{2}$  and  $c' \geq \frac{3}{2}$ .

*Question 3.1.6.* What is the infimum  $c$  such that for any large enough  $t$ , there is a graph that admits a quasi- $K_t$ -minor but no  $K_{ct}$ -minor?

*Question 3.1.7.* Is there a constant  $c'$  such that for every  $t$ , all the  $c' \cdot t$ -colorings of a graph with no  $K_t$ -minor form a single equivalence class?

<sup>1</sup>One bag for each color class.

### 3.1.2 Construction

Let  $n \in \mathbb{N}$  and let  $\eta > 0$ . We build a random graph  $G_n$  on vertex set  $\{a_1, \dots, a_n, b_1, \dots, b_n\}$ : for every  $i \neq j$  independently, we select one pair uniformly at random among  $\{(a_i, a_j), (a_i, b_j), (b_i, a_j), (b_i, b_j)\}$  and add the three other pairs as edges to the graph  $G_n$ .

Note that the sets  $\{a_i, b_i\}_{1 \leq i \leq n}$  form a quasi- $K_n$ -minor, as for every  $i \neq j$ , the set  $\{a_i, b_i, a_j, b_j\}$  induces a path on four vertices in  $G_n$ , hence is connected.

Our goal is to argue that if  $n$  is sufficiently large then with high probability the graph  $G_n$  does not admit any  $K_{(\frac{2}{3}+\eta)n}$ -minor. This will yield Theorem 3.1.5. To additionally obtain Theorem 3.1.3, we need to argue that with high probability,  $G_n$  admits an  $n$ -coloring with a different color partition than the natural one, where the color classes are of the form  $\{a_i, b_i\}$ . Informally, we can observe that each of  $\{a_1, \dots, a_n\}$  and  $\{b_1, \dots, b_n\}$  induces a graph behaving like a graph in  $\mathcal{G}_{n, \frac{3}{4}}$  (i.e. each edge exists with probability  $\frac{3}{4}$ ) though the two processes are not independent. This argument indicates that  $\chi(G_n) = O(\frac{n}{\log n})$ , but we prefer a simpler, more pedestrian approach.

Assume that for some  $i, j, k, \ell$ , none of the edges  $a_i b_j, a_j b_k, a_k b_\ell$  and  $a_\ell b_i$  exist. Then the graph  $G_n$  admits an  $n$ -coloring  $\alpha$  where  $\alpha(a_p) = \alpha(b_p) = p$  for every  $p \notin \{i, j, k, \ell\}$  and  $\alpha(a_i) = \alpha(b_j) = i, \alpha(a_j) = \alpha(b_k) = j, \alpha(a_k) = \alpha(b_\ell) = k$  and  $\alpha(a_\ell) = \alpha(b_i) = \ell$  (see Figure 3.1). Since every quadruple  $(i, j, k, \ell)$  has a positive and constant probability of satisfying this property,  $G_n$  contains such a quadruple with overwhelmingly high probability when  $n$  is large.

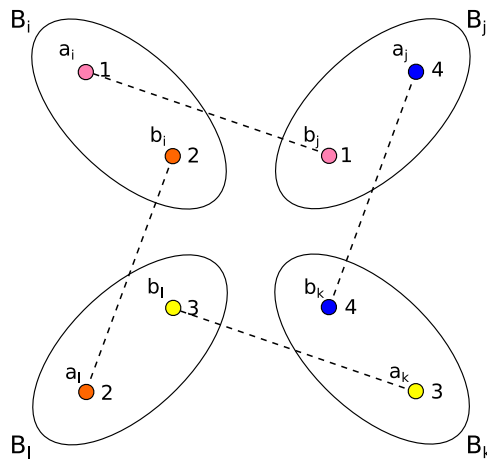

Figure 3.1: A different  $n$ -coloring given an appropriate quadruple.

We are now ready to prove that the probability that  $G_n$  admits a  $K_{(\frac{2}{3}+\eta)n}$ -

minor tends to 0 as  $n$  grows to infinity. We consider three types of  $K_p$ -minors in  $G$ , depending on the size of the bags involved. If every bag is of size 1, we say that it is a *simple*  $K_p$ -minor – in fact, it is a subgraph. If every bag is of size 2, we say it is a *double*  $K_p$ -minor. If every bag is of size at least 3, we say it is a *triple*  $K_p$ -minor. We prove three claims, as follows.

**Claim 13.** For any  $\varepsilon > 0$ ,  $\mathbb{P}(G_n \text{ contains a simple } K_{\varepsilon n}\text{-minor}) \rightarrow 0$  as  $n \rightarrow \infty$ .

**Claim 14.** For any  $\varepsilon > 0$ ,  $\mathbb{P}(G_n \text{ contains a double } K_{\varepsilon n}\text{-minor}) \rightarrow 0$  as  $n \rightarrow \infty$ .

**Claim 15.**  $G_n$  does not contain a triple  $K_{\frac{2}{3}n+1}$ -minor.

Claims 13, 14 and 15 are proved in subsections 3.1.2, 3.1.2 and 3.1.2, respectively. If a graph admits a  $K_p$ -minor, then in particular it admits a simple  $K_a$ -minor, a double  $K_b$ -minor and a triple  $K_c$ -minor such that  $a + b + c \geq p$ . Combining Claims 13, 14 and 15, we derive the desired conclusion.

### No large simple minor

*Proof of Claim 13.* Let  $S$  be a subset of  $k$  vertices of  $G_n$ . The probability that  $S$  induces a clique in  $G_n$  is at most  $\left(\frac{3}{4}\right)^{\binom{k}{2}}$ . Indeed, if  $\{a_i, b_i\} \subseteq S$  for some  $i$ , then the probability is 0. Otherwise,  $|S \cap \{a_i, b_i\}| \leq 1$  for every  $i$ , so we have  $G[S] \in \mathcal{G}_{k, \frac{3}{4}}$ , i.e. edges exist independently with probability  $\frac{3}{4}$ . Therefore, the probability that  $S$  induces a clique is  $\left(\frac{3}{4}\right)^{\binom{k}{2}}$ .

By union-bound, the probability that some subset on  $k$  vertices induces a clique is at most  $\binom{2n}{k} \cdot \left(\frac{3}{4}\right)^{\binom{k}{2}}$ . For any  $\varepsilon > 0$ , we note that  $\binom{2n}{\varepsilon n} \leq 2^{2n}$ . Therefore, the probability that  $G_n$  contains a simple  $K_{\varepsilon n}$ -minor is at most  $2^{2n} \cdot \left(\frac{3}{4}\right)^{\binom{\varepsilon n}{2}}$ , which tends to 0 as  $n$  grows to infinity.  $\square$

### No large double minor

*Proof of Claim 14.* Let  $S'$  be a subset of  $k$  pairwise disjoint pairs of vertices in  $G_n$  such that for every  $i$ , at most one of  $\{a_i, b_i\}$  is involved in  $S'$ .

We consider the probability that  $G_n/S'$  induces a clique, where  $G_n/S'$  is defined as the graph obtained from  $G_n$  by considering only vertices involved in some pair of  $S'$  and identifying the vertices in each pair.

We consider two distinct pairs  $(x_1, y_1), (x_2, y_2)$  of  $S'$ . Without loss of generality,  $\{x_1, x_2, y_1, y_2\} = \{a_i, a_j, a_k, a_\ell\}$  for some  $i, j, k, \ell$ . The probability that there is an edge between  $\{x_1, y_1\}$  and  $\{x_2, y_2\}$  is  $1 - \left(\frac{1}{4}\right)^4$ . In other words,  $\mathbb{P}(E((x_1, y_1), (x_2, y_2)) = \emptyset) = \left(\frac{1}{4}\right)^4$  and since at most one of  $\{a_i, b_i\}$  is involved



### 3. Other reconfiguration problems

---

in  $S'$  for all  $i$ , all such events are mutually independent. Therefore, the probability that  $S'$  yields a quasi- $K_{|S'|}$ -minor is  $\left(1 - \left(\frac{1}{4}\right)^4\right)^{\binom{|S'|}{2}}$ .

For any  $\varepsilon' > 0$ , the number of candidates for  $S'$  is at most  $\binom{2n}{2\varepsilon'n}$  (the number of choices for a ground set of  $2\varepsilon'n$  vertices) times  $(2\varepsilon'n)!$  (a rough upper bound on the number of ways to pair them). Note that  $\binom{2n}{2\varepsilon'n} \cdot (2\varepsilon'n)! \leq (2n)^{2\varepsilon'n}$ . We derive that the probability that there is a set  $S'$  of size  $\varepsilon'n$  such that  $G_n/S' = K_{|S'|}$  is at most  $(2n)^{2\varepsilon'n} \cdot \left(1 - \left(\frac{1}{4}\right)^4\right)^{\binom{\varepsilon'n}{2}}$ , which tends to 0 as  $n$  grows large.

Consider a double  $K_k$ -minor  $S$  of  $G_n$ . Note that no pair in  $S$  is equal to  $\{a_i, b_i\}$  (for any  $i$ ), as every bag induces a connected subgraph in  $G_n$ . We build greedily a maximal subset  $S' \subseteq S$  such that  $S'$  involves at most one vertex out of every set of type  $\{a_i, b_i\}$ . Note that  $|S'| \geq \frac{|S|}{3}$ . By taking  $\varepsilon' = \frac{\varepsilon}{3}$  in the above analysis, we obtain that the probability that there is a set  $S$  of  $\varepsilon n$  pairs that induces a quasi- $K_{|S'|}$ -minor tends to 0 as  $n$  grows large. □

#### No large triple minor

*Proof of Claim 15.* The graph  $G_n$  has  $2n$  vertices, and a triple  $K_k$ -minor involves at least  $3k$  vertices. It follows that if  $G_n$  contains a triple  $K_k$ -minor then  $k \leq \frac{2n}{3}$ . □

## 3.2 Connected greedy edge-coloring

### 3.2.1 Introduction

As discussed in Section 1.3.3, a naive way to color the vertices of a graph is to consider them one by one and to color each vertex with the smallest color that does not appear on any neighbor of it. More formally, let  $G$  be a graph and  $\mathcal{O} = (v_1, \dots, v_n)$  be a linear ordering of its vertices. The **greedy** coloring of  $G$  following  $\mathcal{O}$  is the coloring  $\alpha$  of  $G$  obtained by coloring  $v_i$  with the smallest color  $k$  such that there is no  $v_j \in N(v_i)$  with  $j < i$  and  $\alpha(v_j) = k$ , for  $i$  from 1 to  $n$ . The maximum number of colors that can be used using a greedy procedure is called the *Grundy number*, and computing this value can be a convenient way to bound any heuristic used to color a graph (see [BFKS18] and [Zak06]). Finding a good ordering of the vertices can indeed seem like an easier way to find a coloring with not “too many” colors. However, if we choose a bad ordering then the difference between the number of colors involved in a greedy coloring and the chromatic number can be arbitrary large, even for trees.

On the other hand, note that there is always an ordering  $\mathcal{O}$  of the vertices of a graph  $G$  such that the greedy coloring following  $\mathcal{O}$  involves the optimal number of colors, i.e.  $\chi(G)$ . The argument is simple: consider a  $\chi(G)$ -coloring  $\alpha$  of  $G$ , and put first all the vertices colored 1 in  $\alpha$ , then all the vertices colored 2, etc. The greedy coloring following this ordering might not be exactly the same as  $\alpha$ , but it will use  $\chi(G)$  colors in total. Nevertheless, finding such an ordering is equivalent to directly computing an optimal coloring, so this is not a helpful approach.

A more interesting approach is through connected orderings. A *connected ordering* is an ordering where each vertex (except the first one) has one of its neighbors as predecessor – in other words,  $G[\{v_1, \dots, v_i\}]$  is connected for every  $i$ . Note that disconnected graphs do not admit a connected ordering: throughout this section we only consider connected graphs. Indeed, for coloring purposes, one can simply handle each connected component independently. The minimum number of colors used by the greedy procedure when following a connected ordering is called the *connected chromatic number* of  $G$  and is denoted  $\chi_c(G)$ . Surprisingly, the connected chromatic number behaves similarly to the chromatic number. In fact, Benevides, Campos, Dourado, Griffiths, Morris, Sampaio and Silva [BCD<sup>+</sup>14] proved that  $\chi_c(G) \leq \chi(G) + 1$  for every graph  $G$ .

As discussed in Section 1.3.2, edge coloring is a special case of vertex coloring which typically displays significantly meeker behaviour.

Given that edge coloring is a special case of vertex coloring, all the notions discussed earlier extend naturally. Let us denote by  $\chi'_c(G)$  the *connected greedy chromatic index* of  $G$ . The goal of this section is to study this parameter. By

considering vertex colorings of the **line graph** of  $G$ , we obtain  $\chi'(G) \leq \chi'_c(G) \leq \chi'(G) + 1$ . In the case of vertex coloring, it is NP-hard to decide whether  $\chi_c(G) = \chi(G)$  [BCD<sup>+</sup>14]. To the best of our knowledge it is unknown whether this extends to edge coloring, and even whether  $\chi'(G)$  and  $\chi'_c(G)$  can differ. It is however known that  $\chi(G)$  and  $\chi_c(G)$  can differ on claw-free graphs [LT18].

Our first contribution is to prove that deciding  $\chi'_c(G) = \chi'(G)$  is NP-hard, even for graphs of small maximum degree satisfying  $\chi'(G) = \Delta(G)$ .

**Theorem 3.2.1.** *For all  $\Delta \geq 4$ , it is NP-hard to decide whether  $\chi'(G) = \chi'_c(G)$  on the class of graphs with chromatic index  $\Delta$ .*

Our proof also provides an example of a graph  $G$  with  $\chi'_c(G) > \chi'(G)$  of maximum degree 3. When  $G$  is a connected graph of maximum degree 2, then  $G$  is a path or a cycle and it is easy to see that  $\chi'_c(G) = \chi'(G)$ .

In the vertex case,  $2 = \chi(G) = \chi_c(G)$  when  $G$  is bipartite [BCD<sup>+</sup>14]. We show that for bipartite graphs optimal connected orderings also exist in the edge case.

**Theorem 3.2.2.** *If  $G$  is bipartite, then  $\chi'_c(G) = \chi'(G)$ .*

In Theorem 3.2.2, we use Kempe changes to reconfigure a  $k$ -edge coloring to a connected greedy  $k$ -edge coloring. In order to do this we define the notion of ‘reachability’ which might be of independent interest. Let  $G'$  be the subgraph induced by the edges of color  $< k$ . Reachability predicts whether we can ‘jump’ between the components of  $G'$  via a connected ordering that assigns the edges between the components color  $k$ ; by induction, we can find optimal connected orderings for the components of  $G'$ , which we combine to an optimal connected ordering for  $G$ . We can get a similar reachability result for general graphs (Lemma 3.2.7), of which the following is an easy corollary.

**Theorem 3.2.3.** *If  $G$  has maximum degree 3 then  $\chi'_c(G) \leq 4$ .*

However, we did not manage to push through the induction argument used in Theorem 3.2.2 to provide a full answer to the following problem, which we leave open.

**Problem 1** (Question 3 in [MRS20]). *Is it true that  $\chi'_c(G) \leq \Delta + 1$  for each graph  $G$  of maximum degree  $\Delta$ ?*

### 3.2.2 Proof of NP-hardness

In this subsection, we prove Theorem 3.2.1. We first define some auxiliary constructions.

Let  $\Delta \geq 3$  be given. The  $\Delta$ -dimensional hypercube  $Q_\Delta$  with vertex set  $\{0, 1\}^\Delta$  is  $\Delta$ -regular and satisfies  $\chi'(Q_\Delta) = \Delta$ . Indeed, we may reserve a different color for each ‘direction’ as in Figure 3.2. Pick an edge  $xy \in E(Q_\Delta)$ . Let  $Q_\Delta^+$  be the graph with vertex set  $V(Q_\Delta^+) = V(Q_\Delta) \cup \{x', y'\}$  and edge set

$$E(Q_\Delta^+) = (E(Q_\Delta) \setminus \{xy\}) \cup \{xx', yy'\}.$$

Then  $\chi'(Q_\Delta^+) = \Delta$ . An example is given in Figure 3.2.

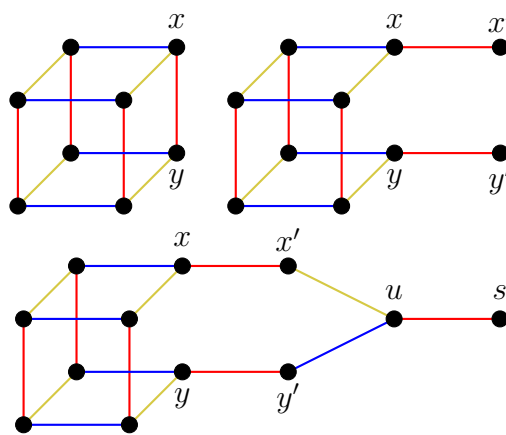

Figure 3.2: The graphs  $Q_3$ ,  $Q_3^+$  and  $H_3$  are depicted with possible 3-edge colorings.

Below we consider the situation in which we attempt to extend a coloring in which one of the edges has been precolored. We assign the lowest available color to the edges in a connected ordering starting from an edge incident with the precolored edge.

**Lemma 3.2.4.** *Let  $\Delta \geq 3$ . Let  $xx', yy' \in E(Q_\Delta^+)$  be the two edges containing a vertex of degree 1.*

- *If  $\alpha$  is a  $\Delta$ -edge coloring of  $Q_\Delta^+$ , then  $\alpha(xx') = \alpha(yy')$ .*
- *If  $xx'$  is precolored with some color  $i \in [\Delta]$ , then there is a connected ordering of the edges of  $Q_\Delta^+$  such that the greedy procedure uses  $\Delta$  colors.*

*Proof.* To see the first claim, suppose that we assign  $xx'$  and  $yy'$  different colors. One of the color classes must then cover an odd number of vertices from  $Q_\Delta$  (because it covers an even number of vertices in  $Q_\Delta^+$  as any color class of an edge coloring of  $Q_\Delta^+$  forms a matching). Let  $v \in V(Q_\Delta)$  be a vertex not covered by this color class. Since  $v$  has degree  $\Delta$ , there are edges of  $\Delta$  different colors incident to it. Hence we have used at least  $\Delta + 1$  colors.

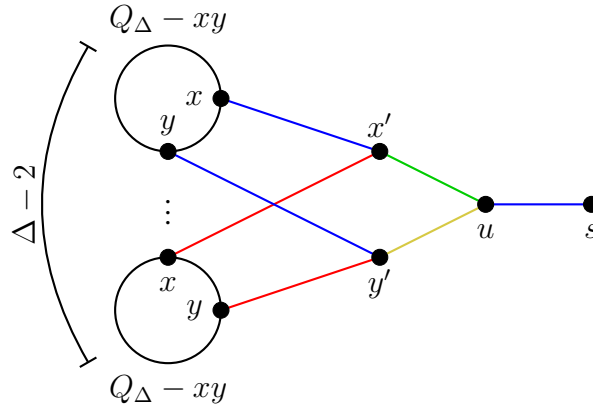

Figure 3.3: The graph  $H$  is depicted with a possible edge coloring.

To see the second claim, fix any  $\Delta$ -edge coloring  $\alpha$  of  $Q_{\Delta}^+$  with  $\alpha(xx') = i$ . Let  $z \in \{x, x'\}$  be the vertex of degree  $\Delta$ . We can now always create an ordering of the edges leading to the edge coloring  $\alpha$ . Indeed, we first color the edge incident to  $z$  which needs to get color 1, then the edge incident to  $z$  that needs to get color 2, etc, until we colored all edges incident to  $z$ . We then pick a neighbor of  $z$  of degree  $\Delta$  and color all edges incident to this one in a similar order. We continue like this until all edges have been colored.  $\square$

We will extend  $Q_{\Delta}^+$  into a gadget  $H$ . Let us first explain the case  $\Delta = 3$ . We obtain the graph  $H_3$  from the graph  $Q_3^+$  by adding a new vertex  $u$  adjacent to the vertices  $x'$  and  $y'$  as well as adding a new vertex  $s$  adjacent to  $u$  as in Figure 3.2. Suppose we have a connected greedy 3-edge coloring of  $H$  starting from  $s$ . By Lemma 3.2.4,  $xx'$  and  $yy'$  must get the same color. Since  $x'u$  and  $y'u$  cannot get the same color, the edges  $xx', yy'$  and  $su$  must all receive the same color. Since we started from  $s$ , some edge from  $\{xx', yy'\}$  is the first edge to be colored from  $Q_3^+$ . Since  $x'$  and  $y'$  have degree 2, this edge will not get color 3. If we force the edge  $su$  to have color 3, and then continue in a connected greedy fashion, then this shows we cannot color all the edges using three colors. On the other hand, if we force it to have color 1 or 2, then we can continue to color  $x'u, xx'$ , the remainder of the hypercube and finally  $yy'$  and  $y'u$  using Lemma 3.2.4. This proves the lemma below in the case  $\Delta = 3$ .

**Lemma 3.2.5.** *For any  $\Delta \geq 3$ , there exists a graph  $H$  of maximum degree  $\Delta$  with a special vertex  $s$  of degree 1 with the following properties.*

- *If the edge incident with  $s$  is precolored with color  $\Delta$ , then there is no connected greedy  $\Delta$ -edge coloring of  $H$  starting from this edge.*

- If the edge incident with  $s$  is precolored with  $i \in [\Delta - 1]$ , then there exists a connected greedy  $\Delta$ -edge coloring of  $H$  starting from this edge.

*Proof.* We extend  $\Delta - 2$  copies of  $Q_{\Delta}^+$  to the graph  $H$ . We first glue all these copies on their respective vertices labelled  $x'$  and  $y'$ . We then obtain the graph  $H$  by adding a new vertex  $u$  adjacent to the (merged) vertices  $x'$  and  $y'$  and a new vertex  $s$  adjacent to  $u$  (see Figure 3.3).

Let  $\alpha$  be a  $\Delta$ -edge coloring. Since  $\alpha(x'u) \neq \alpha(y'u)$ , we find that there exists a  $Q_{\Delta}^+$  copy for which  $\alpha(xx') = \alpha(yy') = \alpha(su)$ , where  $x$  and  $y$  are the vertices in this copy adjacent to  $x'$  and  $y'$  respectively. If we start the coloring from an edge incident to  $u$ , then one of the edges in  $\{xx', yy'\}$  is the first edge to be colored from  $Q_{\Delta}^+$ ; since  $x'$  has degree  $\Delta - 1$ , this edge will not get color  $\Delta$ . Combined with Lemma 3.2.4, this shows that no connected  $\Delta$ -edge coloring starting from  $su$  can exist in which the edge  $su$  is precolored  $\Delta$ .

On the other hand, if  $su$  gets a color strictly smaller than  $\Delta$ , then we first may color  $x'u$ , then all edges incident to  $x'$ , and finally by Lemma 3.2.4 we can further extend the connected ordering in such a way that all copies of  $Q_{\Delta}^+$  are  $\Delta$ -edge colored while no edge incident with  $y'$  receives color  $\Delta$ . So we have at least one color leftover for  $y'u$  (which will in fact need to get color  $\Delta$ ).  $\square$

We are now ready to show that it is NP-hard to decide whether  $\chi'(G) = \chi'_c(G)$  on the class of graphs of maximum degree  $\Delta$ , for all  $\Delta \geq 4$ .

*Proof of Theorem 3.2.1.* Let  $d = \Delta - 1$ , and let  $G$  be an  $n$ -vertex  $d$ -regular graph. We transform  $G$  into a graph  $G'$  of maximum degree  $\Delta$  such that  $\chi'(G) = d$  if and only if  $\chi'_c(G') = \chi'(G')$ . In fact,  $\chi'(G') = \Delta$  and  $|V(G')| \leq \Delta^2 2^{\Delta} n$ . This reduction proves the theorem since deciding whether  $\chi'(G) = d$  is NP-hard on  $d$ -regular graphs for all  $d \geq 3$ , as shown by Leven and Galil [LG83].

Let  $\Delta = d + 1$  and let  $H$  be the graph from Lemma 3.2.5 for that value of  $\Delta$ . For each  $v \in V(G)$ , we create a graph  $G_v$  by merging  $\Delta - 1$  copies of  $H$  on their special vertex  $s$  (see Figure 3.4). The graph  $G'$  is obtained from  $G$  by connecting  $G_v$  to  $v$  via an edge for each  $v \in V(G)$ ; for  $v, v'$  distinct vertices of  $G$ , the graphs  $G_v$  and  $G_{v'}$  are disjoint and have no edges between them. Note that  $\chi'(G') = \Delta$ .

Suppose first that our  $d$ -regular graph  $G$  can be colored using  $d$  colors. Fix a  $d$ -edge coloring  $\alpha$  of  $G$ . There is a connected ordering of the edges of  $G$  that results in the edge coloring  $\alpha$ . Indeed, since  $G$  is  $d$ -regular, whenever we have ‘reached’ a vertex we can assign the edges incident to this vertex the desired colors, starting from the edge colored 1, continuing with the edge colored 2 etc. We may then color the edge from  $v$  to  $G_v$  with color  $d + 1$  for all  $v \in V(G)$ . Continuing in the various copies of  $H$ , the corresponding edge  $su$  gets a color  $< d + 1 = \Delta$  and hence by Lemma 3.2.5 there is a connected ordering in which we can edge color these with  $\Delta$  colors. So  $\chi'_c(G') = \chi'(G')$ .

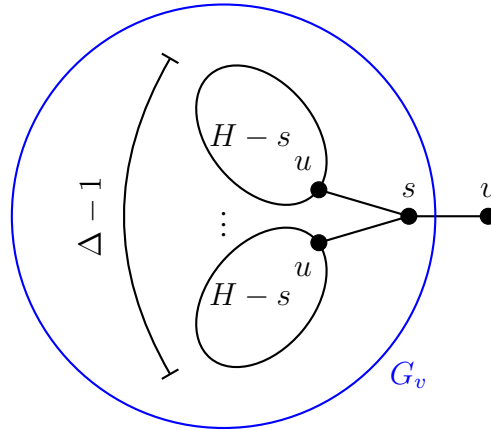

Figure 3.4: We create an instance of the depicted graph for each vertex of  $G$ .

Suppose now that  $G$  is not  $d$ -edge colorable. For contradiction, suppose there is a  $\Delta$ -edge coloring  $\alpha$  that can be obtained via a connected ordering. Since  $G$  is not  $d$ -edge colorable,  $\alpha(vv') = d + 1$  for some  $vv' \in E(G)$ . The two edges between  $v, v'$  and  $G_v, G_{v'}$  are then not colored  $\Delta$ . As  $G_v$  and  $G_{v'}$  are not connected to each other, we may assume that these edges are colored before any of the edges in  $G_v$  are colored. Since  $s$  has degree  $\Delta$ , there is then a copy of  $H$  with vertex  $u$  connecting to  $s$  in  $G_v$  for which  $su$  has color  $\Delta$  and this is the first edge of  $H$  that is colored; this contradicts Lemma 3.2.5. So  $\chi'_c(G) > \chi'(G)$ .  $\square$

To obtain a graph  $G$  of maximum degree 3 with  $\chi'_c(G) > \chi'(G)$ , we take a triangle and give each point a pendant vertex, and take three pairs of copies of the graph  $H_3$  (as depicted in Figure 3.2) for which we identify the vertex labelled  $s$  with one of the pendant vertices, as depicted in Figure 3.5. At least two of the three 'pendant' edges incident with the triangle does not have color 3 in a 3-edge coloring; one of the two  $su$ -type edges adjacent to such an edge hence gets color 3. In a connected greedy edge coloring, for at least one of the two corresponding copies of  $H_3$ , the edge  $su$  is the first to be colored. By Lemma 3.2.5, the coloring then uses at least 4 colors. Hence  $\chi'_c(G) > 3 = \chi'(G)$ .

### 3.2.3 Bipartite graphs

Theorem 3.2.2 is an immediate consequence of the following lemma.

**Lemma 3.2.6.** *Let  $G$  be a connected bipartite graph with  $\chi'(G) \leq k$ . Then for any vertex  $v \in V(G)$ , there exists a connected ordering starting from  $v$  leading to a  $k$ -edge coloring of  $G$ .*

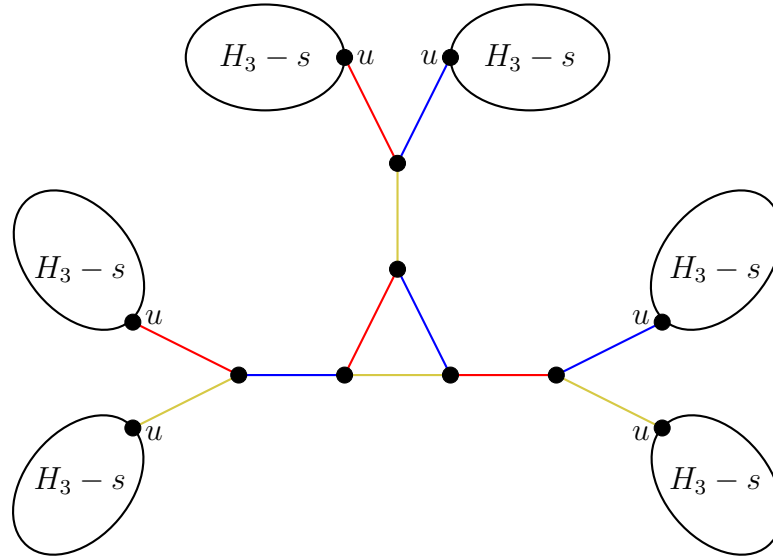

Figure 3.5: A graph  $G$  with maximum degree 3 and  $\chi'_e(G) > \chi'(G)$ . For any 3-edge coloring, there are two edges of type  $su$  colored 3 ‘entering’ a copy of  $H_3$ .

*Proof.* We prove the lemma by induction on  $k$ . If  $G$  is a connected graph with  $\chi'(G) = 1$ , then  $G$  is a single edge. Hence the lemma is true for  $k = 1$ . Suppose now that we have proven the lemma for all  $k' < k$  for some integer  $k \geq 2$ .

Let  $\alpha : E(G) \rightarrow [k]$  be a  $k$ -edge coloring of  $G$  and let  $u, v \in V(G)$ . For  $u, v$  distinct, we say  $u$  *strongly reaches*  $v$  in the coloring  $\alpha$  if  $uv \in E(G)$  and either  $\alpha(uv) < k$  or the degree of  $u$  is  $k$ . Each vertex strongly reaches itself. We now define reachability as the transitive closure of strong reachability: we say  $u$  *reaches*  $v$  in the coloring  $\alpha$  if there is a sequence  $u = v_0, v_1, \dots, v_\ell = v$  of vertices in  $G$  such that  $v_{i-1}$  strongly reaches  $v_i$  for all  $i \in [\ell]$ .

We first show that for every vertex  $v$ , there exists a  $k$ -edge coloring of  $G$  such that  $v$  reaches all vertices of  $G$  in this coloring. Take a  $k$ -edge coloring  $\alpha$  of  $G$  which maximises the number of vertices that  $v$  can reach. Suppose that  $v$  cannot yet reach all vertices. We will strictly increase the set of vertices that  $v$  can reach through a series of Kempe changes.

Let  $A \subseteq V(G)$  be the set of vertices that  $v$  can reach in  $\alpha$  and let  $B = V(G) \setminus A$ . Note that as  $v$  reaches itself,  $v \in A$ . Since  $G$  is connected, there must be an edge  $su$  from some  $s \in A$  to some  $u \in B$ . By the definition of strong reachability, we find that  $s$  has degree strictly smaller than  $k$  and that  $\alpha(su) = k$ . Hence  $s$  misses a color  $x \in [k - 1]$ , that is, it has no edge incident of color  $x$ .

Suppose first that  $u$  has degree  $< k$ . If vertex  $u$  misses color  $x$  as well, then the edge  $su$  forms a  $(k, x)$ -component on its own and a  $(k, x)$ -Kempe change switches the color of  $su$  to  $x$ . This adds the vertex  $u$  to the set of vertices that  $v$



can reach, increasing the set of vertices  $v$  can reach as desired. Hence we may assume that  $u$  misses some color  $y$  but does not miss color  $x$ . Then  $y < k$  and there is some edge  $e$  incident to  $u$  colored  $x$ . Since all edges between  $A$  and  $B$  are colored  $k$ , the  $(x, y)$ -component of  $e$  stays within  $G[B]$ . Hence we may perform an  $(x, y)$ -Kempe change on this component without affecting the set of vertices that  $v$  can reach. Now we are back in the case in which  $u$  and  $s$  both miss color  $x$ , which we already handled.

Suppose now that vertex  $u$  has degree  $k$ . Let  $e$  denote the edge colored  $x$  incident to  $u$ . Note that the  $(x, k)$ -component  $C$  of  $e$  is a path (of which one endvertex is  $s$ ). If it stays within  $G[B \cup \{s\}]$ , then performing an  $(x, k)$ -Kempe change on  $C$  recolors  $su$  with color  $x$  without affecting the colors in  $G[A]$  and hence strictly enlarges the set of vertices that  $v$  can reach. So we may assume that  $C$  intersects  $A$  a second time, say  $s' \in A$  is the vertex closest to  $s$  in the path  $C$ . Since  $s'$  has an edge incident with  $B$ , we find that it has degree  $< k$ . Hence it has some color  $y < k$  missing. Once we ensure  $x$  is missing at  $s'$ , we can do an  $(x, k)$ -Kempe change on the component of  $e$  and strictly increase the set of vertices that  $v$  can reach.

If  $s'$  has an edge incident with color  $x$ , then consider the  $(x, y)$ -component of this edge. This has to stay within  $A$  and performing a Kempe change on it will not affect the set of vertices that  $v$  can reach since  $x, y < k$ . The only problem is that this chain  $C'$  could include the vertex  $s$ . Here is where we use that the graph is bipartite: as can be seen in Figure 3.6, this would create an odd cycle in the graph, since there is an odd number of edges in  $C$  between  $s$  and  $s'$  and an even number of edges in  $C'$  between  $s$  and  $s'$  (since they have different colors missing). Hence we may perform the  $(x, y)$ -Kempe change without affecting the missing color of  $s$ , and can then perform the  $(x, k)$ -Kempe change as desired.

This shows we can always strictly increase the set of vertices that  $v$  can reach. This contradicts the maximality of  $\alpha$ . Hence there exists a coloring  $\alpha$  in which  $v$  can reach all vertices.

Let  $C_1, \dots, C_\ell$  denote the connected components of  $G$  when we remove all edges of  $G$  colored  $k$  in  $\alpha$ , where  $v \in C_1$ . We will show that there is a connected ordering starting from  $v$  that leads to a  $k$ -edge coloring of  $G$  which is a  $(k - 1)$ -edge coloring when restricted to any  $C_i$ . Since  $v$  can reach everything in  $\alpha$ , after possibly renumbering  $C_2, \dots, C_\ell$ , we can find vertices

$$s_i \in C_1 \cup \dots \cup C_i \text{ and } v_{i+1} \in C_{i+1} \cap N_G(s_i),$$

for  $i = 1, \dots, \ell - 1$ , such that for all  $i \in [\ell - 1]$ ,  $s_i$  can strongly reach  $v_{i+1}$  ('reach in one step') and hence  $d_G(s_i) = k$  (since we already know  $\alpha(s_i v_{i+1}) = k$  by the definition of the components).

Since  $C_1$  is a connected bipartite graph with  $\chi'(C_1) \leq k - 1$ , there exists a connected ordering starting from  $v$  that  $(k - 1)$ -edge colors  $C_1$  by the induction

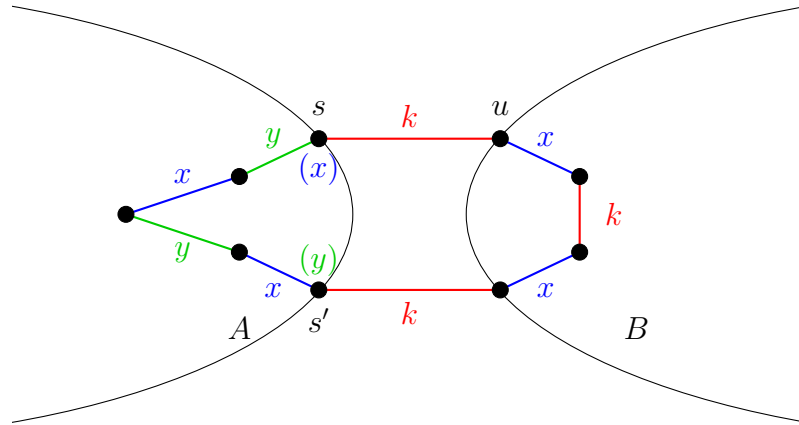

Figure 3.6: If the  $(x, y)$ -chain of  $s'$  includes  $s$ , then  $G$  contains an odd cycle.

hypothesis. By the definition of the components, all edges incident to  $s_1$  except for  $s_1v_2$  have now been colored. We color the edge  $s_1v_2$  next; this obtains color  $k$ . Since  $C_2$  is a connected bipartite graph with  $\chi'(C_2) \leq k - 1$ , there exists a connected ordering starting from  $v_2$  that  $(k - 1)$ -edge colors  $C_2$  by the induction hypothesis. We extend our previous ordering by this connected ordering and continue like this until we have colored all edges within the components. We then color the edges between the components; since color  $k$  will always be available to them, they will all receive a color at most  $k$ .  $\square$

### 3.2.4 Subcubic graphs

Let  $G$  be a graph, let  $\alpha$  be a  $k$ -edge coloring of  $G$  and let  $i \in [k]$ . We say that a vertex  $v \in V(G)$  can  $i$ -reach another vertex  $w \in V(G)$  in  $\alpha$  if there exists a sequence of vertices  $v = v_1, v_2, \dots, v_{\ell+1} = w$  of  $G$  such that for all  $j \in [\ell]$  there is an edge  $v_jv_{j+1} \in E(G)$  and one of the following holds:

- $\alpha(v_jv_{j+1}) < i$ ;
- $v_j$  has incident edges in colors  $1, 2, \dots, \alpha(v_jv_{j+1})$ .

If  $k = i = \Delta$  the maximum degree of  $G$ , then this reduces to the notion of reachability from the proof of Theorem 3.2.2. The proof of Theorem 3.2.3 follows from the lemma below which might be of independent interest.

**Lemma 3.2.7.** *Suppose  $G$  is a graph with maximum degree  $\Delta$  and  $v \in V(G)$ . Then  $G$  has a  $(\Delta + 1)$ -edge coloring  $\alpha$  such that  $v$  can  $\Delta$ -reach all other vertices of  $G$  in  $\alpha$ .*

*Proof.* In this proof, we will omit the  $\Delta$  from  $\Delta$ -reach. By Vizing's theorem [Viz64],  $G$  has at least one  $(\Delta + 1)$ -edge coloring  $\alpha$ . We choose such a coloring  $\alpha$  that maximises the size of the set  $A$  of vertices that  $v$  can reach in  $\alpha$ . Let  $B = V(G) \setminus A$  be the set of vertices that  $v$  cannot reach.

Suppose that  $A \neq V(G)$ . The edges between  $A$  and  $B$  are of color  $\Delta$  or  $\Delta + 1$ . Let  $C \subseteq B$  be the neighbors of  $A$  via edges colored  $\Delta$ . Let  $D \subseteq B$  the set of vertices adjacent to a vertex in  $C$  (which a priori might overlap with  $C$ ). We claim that we can obtain an edge coloring in which  $v$  can reach a strictly larger set of vertices than  $A$  (contradicting the maximality of  $A$ ) as soon as one of the following properties holds.

- (1)  $C$  is empty, i.e. there is no  $\Delta$ -edge between  $A$  and  $B$ .
- (2) There is an  $(x, \Delta)$ -Kempe chain with  $x < \Delta$  which is a path between a vertex in  $A$  and a vertex in  $B$ .
- (3) Some  $c \in C$  has a color  $x \in [\Delta - 1]$  missing.
- (4) Some  $d \in D$  misses color  $\Delta$  or  $\Delta + 1$ .

We will prove the claim after we show that we can assume one of (1) – (4) holds. We suppose all properties above do not hold. Since (1) fails, we know there is an edge from some  $a \in A$  to some  $c \in C$  (which has color  $\Delta$  by definition of  $C$ ). Since  $c$  is not reachable, there is a color  $x < \Delta$  missing at  $a$ . Since (3) fails,  $c$  is incident to an edge  $cd$  of color  $x$ , where  $d \in D$ . As (4) fails, we know that there is some color  $y < \Delta$  missing at  $d$ . Consider a  $(\Delta, y)$ -Kempe chain starting at  $d$ . Since (2) fails, it stays within  $B$ . After performing the Kempe change, there is a vertex in  $D$  with no edge colored  $\Delta$ , contradicting with (4) failing.

To prove the claim in case (1), suppose that there are no edges colored  $\Delta$  between  $A$  and  $B$ . Since  $G$  is connected, there exists an edge from some  $a \in A$  to some  $b \in B$ . Then  $\alpha(ab) = \Delta + 1$ . Let  $x < \Delta + 1$  be the smallest color missing at  $a$ . Since  $b$  has the edge  $ab$  incident in color  $\Delta + 1$ ,  $b$  misses some color  $y < \Delta + 1$ . We do an  $(x, y)$ -Kempe change on the component of  $b$  (this could be empty). Since all the edges between  $A$  and  $B$  are colored  $\Delta + 1$ , this chain stays within  $B$ . After the applying the Kempe change, both  $a$  and  $b$  miss the color  $x$ . We may recolor the edge  $ab$  with color  $x$ , and now the set of vertices that  $v$  can reach has increased (since  $v$  can now reach  $b$  as well).

To prove the claim in case (2), suppose that some  $(x, \Delta)$ -chain for  $x < \Delta$  starts in  $u \in B$  and contains a vertex  $s$  from  $A$ . Let  $a \in A$  and  $b \in B$  such that  $ab$  is the closest edge between  $A$  and  $B$  in this chain to  $s$ . As  $x < \Delta$ , we find  $\alpha(ab) = \Delta$ . Thus  $a$  must have some color  $y < \Delta$  missing (since  $b$  cannot be reached). The  $(x, y)$ -chain starting at  $a$  will stay within  $A$  and performing the

Kempe change does not affect which vertices  $v$  can reach. So we may assume that  $x$  is missing at  $a$  and the  $(x, \Delta)$ -component of  $a$  is a path between  $a$  and  $u$  that only intersects  $A$  in the vertex  $a$ . A Kempe change on this component strictly increases the set of vertices that  $v$  can reach.

We now prove the claim assuming (3). Suppose that  $c \in C$  has a color  $x < \Delta$  missing. Let  $a \in A$  with  $\alpha(ac) = \Delta$  (which exists by the definition of  $C$ ). Let  $y < \Delta$  be a color missing at  $a$ . The  $(x, y)$ -chain starting at  $c$  stays in  $B$ , and hence we may perform a Kempe change and then recolor  $ac$  to  $y$  in order to increase the set of vertices that  $v$  can reach.

Finally, we prove the claim from (4). Suppose  $d \in D$  misses color  $\Delta$  or  $\Delta + 1$ . Let  $c \in C$  be the vertex  $d$  is adjacent to. By (3) we are done unless  $c$  only has the color  $\Delta + 1$  missing. If  $\Delta + 1$  is missing at  $d$ , then we recolor  $cd$  to color  $\Delta + 1$  in order to reduce to (3). So  $\Delta$  is missing at  $d$ . Let  $a \in A$  with  $\alpha(ac) = \Delta$ . Let  $y = \alpha(cd) < \Delta$  and let  $x < \Delta$  be a missing color at  $a$ . We may perform an  $(x, y)$ -Kempe change starting at  $a$  to ensure that  $a$  misses color  $y$ . The only vertices on the  $(y, \Delta)$ -Kempe chain containing  $c$  are then  $a$  and  $d$ . After we apply a Kempe change on this chain, the set of vertices that  $v$  can reach has strictly increased again.  $\square$

We are now ready to prove that any graph of maximum degree  $\Delta \leq 3$  satisfies  $\chi'_c(G) \leq \Delta + 1$ .

*Proof of Theorem 3.2.3.* Let  $G$  be a graph of maximum degree 3. Pick a vertex  $v \in V(G)$ . Let  $\alpha$  be a 4-edge coloring of  $G$  in which  $v$  can 3-reach all other vertices of  $G$ ; this exists by the lemma above.

The proof follows the same argument as the last two paragraphs of the proof of Lemma 3.2.6, now using the fact that any  $(1, 2)$ -component can be 2-edge colored in a connected greedy fashion starting from any vertex instead of applying the induction hypothesis.

Let  $C_1$  be the  $(1, 2)$ -component of  $v$ . After doing a  $(1, 2)$ -Kempe change if needed, we can color  $C_1$  in a connected greedy fashion starting from  $v$ . If  $G$  has more components, then since  $v$  can 3-reach all other vertices, there must be a  $(1, 2)$ -component  $C_2 \neq C_1$  and vertices  $v_2 \in C_2$  and  $s_1 \in C_1$  such that  $s_1v_2 \in E(G)$ , and either  $\alpha(s_1v_2) < 3$  or  $s_1$  has incident edges in colors  $1, \dots, \alpha(s_1v_2)$  in  $\alpha$ . Since  $s_1$  and  $v_2$  are in different  $(1, 2)$ -components, we conclude the latter holds. Since  $G$  has maximum degree 3, it follows that  $\alpha(s_1v_2) = 3$ . Hence all edges incident to  $s_1$  have been colored apart from  $s_1v_2$ , which we put next in the connected ordering. After performing a  $(1, 2)$ -Kempe change if needed, we 2-edge color the edges of  $C_2$  in a connected greedy fashion starting from  $v_2$ . (Note that there might be no edges to color in this step, as the component might consist of only  $v_2$ .) As long as the edges of some  $(1, 2)$ -component have not

been colored, we can continue the connected ordering in a similar fashion. The resulting (partial) coloring has the same  $(1, 2)$ -components as  $\alpha$  and colored an edge 3 if and only if it has color 3 in  $\alpha$ . We finish the connected ordering by first coloring the edges colored 3 by  $\alpha$  and then the edges colored 4 by  $\alpha$ ; all these edges receive a color at most 4.  $\square$

### **Addendum**

Since the work was published, this result has been improved by Laurent Beaudou, Caroline Brosse, Oscar Defrain Florent Foucaud, Aurélie Lagoutte, Vincent Limouzy and Lucas Pastor [BBD<sup>+</sup>21]. They generalize the argument of the proof and show in particular that for any perfect graph  $G$ ,  $\chi_c(G) = \chi(G)$ .



# Chapter 4

## From coloring to edge-labeling

In this chapter we present our work on coloring of planar graphs using reduction to edge-labeling of an auxiliary graph. We first present joint work with František Kardoš on signed coloring of signed planar graphs [KN21], this work was published in the European Journal of Combinatorics. We then present joint work with František Kardoš towards a conjecture on the chromatic index of triangle-free planar graphs of maximum degree 4; unfortunately, this work has not lead a result regarding the conjecture, and we present here our approach and partial results. For both of these questions, our approach consists in reducing the original problem to a problem of edge-labeling of an auxiliary graph, the dual graph for the first question, and the medial graph for the second one.

### 4.1 4-signed coloring of signed planar graphs

#### 4.1.1 Introduction

Let  $G$  be a graph and  $\sigma : E(G) \rightarrow \{-1, +1\}$  be a mapping. As mentioned in Section 1.3.6, the pair  $(G, \sigma)$  is called a **signed graph**,  $\sigma$  is called the **signature** of the graph, and  $G$  the **underlying graph**. For convenience, when there are no ambiguities, we only write  $G$  to denote the signed graph.

Signed graph is a notion introduced by Harary in 1953 [H<sup>+</sup>53]. **Switching** a vertex  $v$  in a signed graph consists of switching the sign of every edge incident with  $v$ . This operation induces equivalence classes on signed graphs having the same underlying graph.

Because switching a vertex preserves the sign of every cycle in the graph (i.e., the product of the signs of the edges composing the cycle), the equivalence classes with respect to switching can be characterized by the sign of the cycles [Zas82b]: Two signed graphs  $G_1$  and  $G_2$  are equivalent if and only if every cycle

of  $G_1$  has the same sign as the corresponding cycle of  $G_2$ .

Zaslavsky [Zas82a] defined a coloring of a signed graph  $G$  with  $k$  colors (or, equivalently, a coloring with  $2k + 1$  signed colors) as a mapping

$$c : V(G) \rightarrow \{-k, -(k-1), \dots, -1, 0, 1, \dots, k-1, k\}$$

such that for every edge  $e = uv \in E(G)$ ,  $c(u) \neq \sigma(e) \cdot c(v)$ .

A signed coloring corresponding to the Zaslavsky's definition is preserved by the switching operation: When switching a vertex  $v$  in a colored signed graph  $G$ , switching the sign of the color of  $v$  preserves the coloring of  $G$ .

Máčajová, Raspaud and Škoviera [MRŠ16] introduced the chromatic number of a signed graph using Zaslavsky's definition of a coloring in the following way: A signed graph is called  $k$ -colorable for  $k$  even ( $k$  odd) if there exists a mapping  $c : V(G) \rightarrow \{-k/2, -(k/2 - 1), \dots, -1, 1, \dots, k/2 - 1, k/2\}$  ( $c : V(G) \rightarrow \{-(k-1)/2, -((k-1)/2 - 1), \dots, -1, 0, 1, \dots, (k-1)/2 - 1, (k-1)/2\}$ , respectively), such that for every edge  $e = uv \in E(G)$ ,  $c(u) \neq \sigma(e) \cdot c(v)$ .

Given a signed graph  $(G, \sigma)$ , we denote by  $\chi(G, \sigma)$  (or  $\chi(G)$ ) the *chromatic number* of  $(G, \sigma)$ , the smallest integer  $k$  such that  $(G, \sigma)$  is  $k$ -colorable.

Máčajová, Raspaud and Škoviera conjectured that the four-color theorem holds for the signed planar graphs as well :

**Conjecture 4.1.1.** [MRŠ16] *Every simple signed planar graph  $(G, \sigma)$  has  $\chi(G, \sigma) \leq 4$ .*

Coloring of signed graphs is closely related to list coloring, and Conjecture 4.1.1 would in fact imply a conjecture about a special type of list coloring of (non-signed) graphs called *weak list coloring*.

A list assignment  $L$  is *symmetric* if, for every vertex  $v$  of  $G$  and for every color  $i$  we have  $i \in L(v)$  if and only if  $-i \in L(v)$ . A graph  $G$  is  *$k$ -weakly choosable* if  $G$  is  $L$ -colorable for every symmetric list assignment  $L$  such that for every vertex  $v$ ,  $|L(v)| \geq k$ . The *weak choice number* of a graph  $G$  is the smallest  $k$  such that  $G$  is  $k$ -weakly choosable; this number is denoted  $ch^w(G)$ .

Kündgen and Ramamurthi [KR02] proposed the following generalization of the four-color theorem:

**Conjecture 4.1.2.** [KR02] *Let  $G$  be a planar graph. Then  $ch^w(G) \leq 4$ .*

Zhu [Zhu20] showed that Conjecture 4.1.1 implies Conjecture 4.1.2. In this section, we prove that Conjecture 4.1.1 is false.

## 4.1.2 Results

Before introducing a counterexample to Conjecture 4.1.1, we translate the problem of vertex coloring a signed planar graph to a problem of edge labeling its dual.



As discussed in Section 1.3.4, this translation generalizes the well-known correspondence between 4-colorings of a planar triangulation and 3-edge-colorings of the dual, used in the proof of the four-color theorem (see [RSST97]).

Let  $G$  be a **3-connected** signed planar graph. By the classical result of Whitney [Whi33], there is a unique embedding of  $G$  in the plane (up to the choice of the outer face) and the faces of  $G$  are well-defined; moreover, each face boundary is a cycle. This allows us to speak about the dual graph of  $G$  without specifying the embedding of  $G$  in the plane, since it is uniquely determined.

The sign of a face  $f$  is defined as the sign of its boundary cycle. In particular, a face  $f$  is positive (negative) if the facial cycle of  $f$  contains an even (odd, respectively) number of negative edges.

Let  $G^*$  be the **dual** graph of  $G$ . We define the sign of a vertex  $f^*$  of  $G^*$  as the sign of the corresponding face  $f$  of  $G$ . Note that the number of negative faces in  $G$  is always even, which implies that the number of negative vertices in  $G^*$  is always even as well.

Observe that the set of negative faces in  $G$  is invariant with respect to switching, and thus the sign labeling of the vertex set of the dual graph  $G^*$  is the same for every primal graph  $G$  belonging to a same switching class.

In the figures, the positive vertices will be represented by simple dots, and the negative ones will be represented by circles with a minus sign inside.

Let  $H$  be a 3-connected planar graph and let  $\ell : E(H) \rightarrow \{0, a, b\}$  be an edge labeling of  $H$ , where 0,  $a$ , and  $b$  are arbitrary symbols. We denote  $d_x(v)$  the number of edges incident with  $v$  labelled  $x$  for  $v \in V(H)$  and  $x \in \{0, a, b\}$ .

**Definition 4.1.3.** *Let  $H$  be a 3-connected planar graph with an even number of negative vertices and let  $\ell$  be a  $\{0, a, b\}$ -edge-labeling of  $H$ . The labeling  $\ell$  is a weak edge labeling of  $H$  if*

- (i)  $d_0(v) \equiv d_H(v) \pmod{2}$ , and
- (ii.a)  $d_a(v) \equiv d_b(v) \equiv d_H(v) \pmod{2}$  if  $v$  is a positive vertex, or
- (ii.b)  $d_a(v) \equiv d_b(v) \equiv d_H(v) + 1 \pmod{2}$  if  $v$  is a negative vertex.

In particular, if  $H$  is a **cubic** planar graph with an even number of negative vertices, then a weak edge labeling of  $H$  is a  $\{0, a, b\}$ -edge-labeling of  $H$  such that

- if  $v$  is positive, then it is incident with one edge of each label from  $\{0, a, b\}$ ,
- if  $v$  is negative, then it is incident with one edge labelled 0, and the two other edges have the same label  $x \in \{0, a, b\}$ .

**Conjecture 4.1.4.** *Every 3-connected planar graph with an even number of negative vertices has a weak edge labeling.*

**Theorem 4.1.5.** *Conjectures 4.1.1 and 4.1.4 are equivalent.*

*Proof.* We first prove that Conjecture 4.1.1 implies Conjecture 4.1.4.

Let  $G = (V, E)$  be a graph and  $T \subseteq V$  be a set of vertices of even order. A  $T$ -join is a subgraph  $F$  of  $G$  such that  $d_F(v)$  is odd if and only if  $v \in T$ . In order to build a  $T$ -join of  $G$ , it suffices to partition the vertices of  $T$  into disjoint pairs  $(u, v)$ , and for each pair, consider a path from  $u$  to  $v$ . A binary sum of these paths forms a  $T$ -join of  $G$ .

Let  $H$  be a 3-connected planar graph with an even number of negative vertices. Let  $T$  be the set of negative vertices of  $H$ . Then there exists a  $T$ -join  $F$  of  $H$ .

Let  $\sigma$  be the signature of  $G = H^*$  defined by

$$\sigma(e) = \begin{cases} 1 & \text{if } e^* \notin F, \\ -1 & \text{if } e^* \in F. \end{cases}$$

By definition, a face  $f$  of  $G$  is negative if and only if the corresponding vertex  $f^*$  of  $H$  is negative.

The edges of  $H$  inherit the signs of their dual counterparts. We denote  $d_x^+(v)$  ( $d_x^-(v)$ ) the number of positive (negative, respectively) edges labeled  $x$  incident with  $v$ .

Let  $\varphi$  be a 4-coloring of  $(G, \sigma)$  with colors from  $\{-2, -1, 1, 2\}$ . Let  $e = uv$  be an edge of  $G$  and  $e^*$  be the edge of  $G^*$  corresponding to  $e$ . The label  $\varphi^*(e^*)$  of  $e^*$  is defined depending on the sign of  $e$  and the colors of  $u$  and  $v$  in the following way:

$$\varphi^*(e^*) = \begin{cases} 0 & \text{if } \varphi(u) = -\sigma(uv) \cdot \varphi(v), \\ a & \text{if } \sigma(uv) \cdot \varphi(u) \cdot \varphi(v) = 2, \\ b & \text{if } \sigma(uv) \cdot \varphi(u) \cdot \varphi(v) = -2. \end{cases} \quad (4.1)$$

Observe that if  $\varphi(u) \neq \pm\sigma(uv) \cdot \varphi(v)$ , then  $\{|\varphi(u)|, |\varphi(v)|\} = \{1, 2\}$ , and so  $\varphi^*$  is well-defined. It suffices to prove that  $\varphi^*$  is a weak edge labeling.

Let  $e = uv$  be an edge of  $G$ . When passing from  $\varphi(u)$  to  $\varphi(v)$ , the color may (or may not) change the sign and/or change the absolute value.

Let  $f$  be a face of  $G$ . Consider the edges of the cycle defining the boundary of  $f$ . The following observations are direct consequences of the definition of  $\varphi^*$ :

1. Each change of the absolute value of the vertex color corresponds to an  $a$ - or  $b$ -edge; the number of such changes around  $f$  is even. Therefore,

there is an even number of  $a$ - or  $b$ -labeled edges incident with  $f^*$ , which is equivalent to

$$d_0(f^*) \equiv d_H(f^*) \pmod{2},$$

and so  $\varphi^*$  satisfies the condition (i) of Definition 4.1.3. In other words,

$$d_a(f^*) \equiv d_b(f^*) \pmod{2}.$$

In particular, if  $f$  is a triangle, then there is an odd number of 0-labeled edges incident with  $f^*$ .

2. Each change of the sign of the vertex color corresponds either to a positive 0- or  $b$ -labeled edge, or to a negative  $a$ -labeled edge; the number of such changes around  $f$  has to be even again. Therefore,

$$d_0^+(f^*) + d_b^+(f^*) + d_a^-(f^*) \equiv 0 \pmod{2},$$

which is equivalent to

$$d_0^+(f^*) + d_b^+(f^*) + d_a^+(f^*) \equiv d_a^-(f^*) + d_a^+(f^*) \pmod{2}.$$

In other words,

$$d^+(f^*) \equiv d_a(f^*) \pmod{2},$$

and so the total number of positive edges incident with  $f$  in  $G$  has the same parity as the total number of  $a$ -labeled edges incident with  $f^*$  in  $G^*$ . Hence, the labeling  $\varphi^*$  satisfies also the condition (ii) of Definition 4.1.3.

In particular, if  $f$  is a positive triangle, then there is an odd number of  $a$ -labeled edges (and of  $b$ -labeled edges) incident with  $f^*$ ; if  $f$  is a negative triangle, then there is an even number of  $a$ -labeled edges (and of  $b$ -labeled edges) incident with  $f^*$ .

Conversely, let  $(G, \sigma)$  be a 3-connected signed planar graph. Let  $\varphi^*$  be a weak edge labeling of  $G^*$ . We define a coloring of  $G$  in the following way: Let  $T$  be a spanning tree of  $G$  rooted at a vertex  $r$ . We set  $\varphi(r) = 1$ . For a vertex  $u \neq r$  of  $G$ , the color of  $u$  will depend on the color of its father  $v$  in the spanning tree, the label of the edge  $e^*$  dual to the edge  $e = uv$  and the sign of  $e$  in the following way:

$$\varphi(u) = \begin{cases} \sigma(e) \cdot (\sigma(\varphi(v)) \cdot 3 - \varphi(v)) & \text{if } \varphi^*(e^*) = a, \\ -\sigma(e) \cdot (\sigma(\varphi(v)) \cdot 3 - \varphi(v)) & \text{if } \varphi^*(e^*) = b, \\ -\sigma(e) \cdot \varphi(v) & \text{if } \varphi^*(e^*) = 0. \end{cases} \quad (4.2)$$

Here, by  $\sigma(\varphi(v))$  we mean the sign (in the classical sense) of the color of  $v$ , and so  $\sigma(\varphi(v)) \cdot 3 - \varphi(v) \in \{-2, 2, -1, 1\}$ .

We claim that the coloring  $\varphi$  of  $G$  defined in this way and the labeling  $\varphi^*$  of  $G^*$  satisfy (4.1) for every edge  $e$  of  $G$ , and so  $\varphi$  is a proper 4-coloring of  $G$ .

It is straightforward to verify that the formulae (4.1) and (4.2) are equivalent for every edge  $e \in T$ . The edges of  $G^*$  dual to the edges from  $E(G) \setminus E(T)$  form a spanning tree of  $G^*$ . We prove that (4.1) is verified for these edges by induction.

Let  $f^*$  be a vertex of  $G^*$  corresponding to a face  $f$  of  $G$  such that (4.1) has already been verified for all the incident edges but one; let that edge be  $e_0 = uv$ . Since, for each  $x \in \{0, a, b\}$ , the parity of the  $x$ -labeled edges incident with  $f^*$  is determined by the size and the sign of  $f$ , the label of  $e_0^*$  is uniquely determined by the labels of the other edges incident with  $f^*$  and the sign of  $e$ .

Let  $P^*$  be the set of edges incident with  $f^*$  distinct from  $e_0^*$ , let  $P$  be the corresponding path from  $u$  to  $v$  along  $f$  in  $G$ . By (4.1), for every edge  $e \in P$ ,  $\varphi^*(e^*) \in \{a, b\}$  if and only if the colors of the end-vertices of  $e$  have different absolute values. There is an even number of changes of absolute values of the colors of vertices around  $f$ . Therefore, by (i),  $\varphi^*(e_0^*) \in \{a, b\}$  if and only if the colors of  $u$  and  $v$  have different absolute values.

Similarly, by (4.1), an edge  $e$  of  $P$  represents a change of the sign of the colors of the vertices if and only if  $e^*$  is a positive 0- or  $b$ -labeled edge or a negative  $a$ -labeled edge. Clearly, there is an even number of sign changes around  $f$ . Moreover, by (i) and (ii), there is always an even number of such edges incident with  $f^*$ , including  $e_0^*$ ; therefore,  $\varphi(u)$  and  $\varphi(v)$  have different signs if and only if  $e_0^*$  is a positive 0- or  $b$ -labeled edge or a negative  $a$ -labeled edge.

The last two paragraphs combined together imply that (4.1) (or, equivalently, (4.2)) is true for the edge  $e_0 = uv$ .  $\square$

**Definition 4.1.6.** *Let  $H$  be a 3-connected planar graph with an even number of negative vertices and let  $\ell$  be a  $\{0, a, b\}$ -edge-labeling of  $H$ . The labeling  $\ell$  is a strong edge labeling of  $H$  if*

- (i)  $\ell$  is a weak edge labeling of  $H$ , and
- (ii)  $d_0(v) < d_H(v)$  for every odd-degree vertex  $v$  of  $H$ .

Observe that  $d_0(v) = d_H(v)$  is possible only if  $v$  is a negative vertex of odd degree.

**Conjecture 4.1.7.** *Every 3-connected planar graph with an even number of negative vertices has a strong edge labeling.*

**Theorem 4.1.8.** *Conjectures 4.1.4 and 4.1.7 are equivalent.*

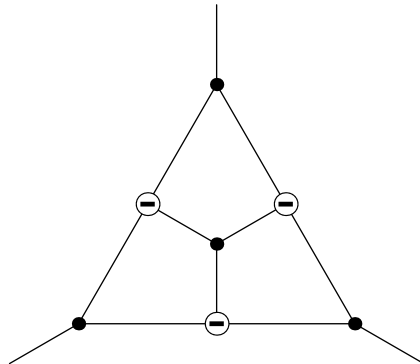

Figure 4.1: An example of a gadget used to replace an odd negative vertex (here  $k = 3$ ).

*Proof.* Trivially, Conjecture 4.1.7 implies Conjecture 4.1.4.

Let  $k \geq 3$  be an odd integer. We define  $W_k$  as the graph obtained from an all-negative cycle of length  $k$  by subdividing each edge using a positive vertex (and thus creating a cycle of length  $2k$  with alternating vertex signs), by adding a pending edge to every positive vertex, and by adding a positive vertex adjacent to all negative vertices of the cycle. See Figure 4.1 for an illustration.

We call the edges of the outer  $2k$ -cycle in  $W_k$  *ring edges*, and the edges joining negative vertices of the cycle to the central positive vertex *spokes*.

Assume that Conjecture 4.1.4 is true. Let  $H$  be a 3-connected planar graph with an even number of negative vertices. Let  $H'$  be the graph obtained from  $H$  by replacing every odd negative vertex  $v$  by a copy of  $W_{d(v)}$ . Since the graph  $H'$  is planar, 3-connected and has an even number of negative vertices, it has a weak edge labeling.

We claim that we can reduce this weak edge labeling of  $H'$  to a strong edge labeling of  $H$  simply by contracting each gadget to a single (negative) vertex, keeping the labels of the edges.

Let  $W$  be a copy of  $W_k$  in  $H'$  for some odd  $k \geq 3$ .

First observe that not all the edges leaving  $W$  are labeled 0. Otherwise, all the ring edges would be labeled  $a$  or  $b$ . However, along the ring, a positive vertex corresponds to a change from  $a$  to  $b$  (or vice versa), whereas a negative vertex cannot be incident with an  $a$ - and  $b$ -labeled edge at the same time. There has to be an even number of changes, but there is an odd number of positive ring vertices, a contradiction.

We need yet to prove that the number of edges leaving  $W$  labeled  $a$  ( $b$ , respectively) is even; the fact that the number of edges leaving  $W$  labeled 0 is odd will follow automatically.

Let us count the number of incidences with  $a$ -labeled edges. Since the central

vertex is a positive vertex of odd degree, it is incident with an odd number of  $a$ -labeled edges. There are an odd number of negative vertices on the ring, each of them is incident with an even number of  $a$ -labeled edges. There are an odd number of positive vertices on the ring, each of them is incident with an odd number of  $a$ -labeled edges.

Therefore, in total, there are an even number of  $a$ -labeled edge incidences in  $W$ , and so there are an even number of edges leaving  $W$  labeled  $a$ .  $\square$

Let  $H$  be a cubic graph with an even number of negative vertices. A 2-factor  $F$  of  $H$  is said to be *consistent* if every cycle of  $F$  has an even number of positive vertices.

As a direct consequence of the definition of the strong edge labeling, we get the following characterization:

**Corollary 4.1.9.** *Let  $H$  be a 3-connected cubic planar graph with an even number of negative vertices. Then  $H$  has a strong edge labeling if and only if  $H$  has a consistent 2-factor  $F$ .*

*Proof.* If  $H$  has a strong edge labeling, then for each  $v \in V(H)$ ,  $d_a(v) + d_b(v) = 2$ . Hence, the edges labeled  $a$  or  $b$  form a 2-factor  $F$  of  $H$ . Moreover, as for  $v \in V(H)$ ,  $v$  is a positive vertex if and only if  $d_a(v) = d_b(v) = 1$ , each cycle of  $F$  must have an even number of positive vertices.

Conversely, assume that  $H$  has a consistent 2-factor  $F$ . For each cycle  $C \in F$ , choose an edge  $e \in C$ , and label  $e$  with  $a$ . Then, label the other edges of  $C$  with  $a$  and  $b$ , in such a way that the labels change only at positive vertices. The edges that are not part of  $F$  are labeled 0. It is easy to see that such a labeling is a strong edge labeling of  $H$ .  $\square$

Observe that if  $H$  is a hamiltonian cubic planar graph with an even number of negative vertices, then any Hamilton cycle of  $H$  is a consistent 2-factor.

We look at the properties of consistent 2-factors of the Tutte fragment (see Figure 4.2), a building block for creating non-hamiltonian cubic planar graphs.

**Lemma 4.1.10.** *Let  $H$  be a 3-connected cubic planar graph with an even number of negative vertices, containing a copy of the Tutte fragment  $T_0$  attached by the edges  $e_1, e_2, e_3$ , as depicted in Figure 4.2. Then every consistent 2-factor  $F$  of  $H$  contains the edge  $e_1$ .*

*Proof.* Assume that  $e_1$  is not in  $F$ . Then  $e_4, e_5$  are in  $F$ . Moreover, as there is an odd number of positive vertices in the fragment, the edges  $e_2$  and  $e_3$  have to be in  $F$ .

We introduce a sequence of claims, each one being easy to check.

- $e_{21} \in F$ . If not, then  $e_{23}, e_{24} \in F$ , and so there would be an odd number of positive vertices left in the fragment to be covered by  $F$ .

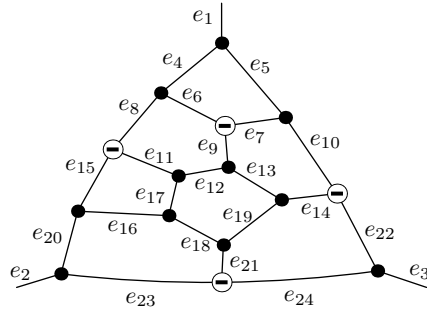

Figure 4.2: A copy of the Tutte fragment with a particular choice of negative vertices.

- $e_9 \in F$ . If not, then there would be a 4-cycle in  $F$  with three positive vertices.
- $e_{17} \in F$ . If not, then  $e_{11}, e_{12}, e_{16}, e_{18} \in F$ , and so  $e_{13}, e_{19} \notin F$ , so  $F$  is not a 2-factor.
- $e_{15} \in F$ . If not, then  $e_8, e_{11}, e_{16}, e_{20} \in F$ , and so  $e_6, e_{12}, e_{18}, e_{23} \notin F$ , meaning  $e_7, e_{13}, e_{19}, e_{24} \in F$ , so  $F$  does not cover all the vertices of the fragment.
- $e_{14} \in F$ . If not, then  $e_{10}, e_{13}, e_{19}, e_{22} \in F$ , and so  $e_7, e_{12}, e_{18}, e_{25} \notin F$ , meaning  $e_{11}, e_{16} \in F$ , so  $F$  contains a 4-cycle with three positive vertices.

From the previous claims we infer that if  $H$  has a consistent 2-factor  $F$  such that  $e_1 \notin F$ , then  $e_2, e_3, e_4, e_5, e_9, e_{14}, e_{15}, e_{17}$  and  $e_{21}$  are in  $F$ , as depicted in Figure 4.3, left. The remaining edges form a cycle, so we only have two choices to complete  $F$ . Each of these leads to a cycle with an odd number of positive vertices (see Figure 4.3).  $\square$

**Theorem 4.1.11.** *There exists a 3-connected cubic planar graph with an even number of negative vertices with no consistent 2-factor.*

*Proof.* Let  $T$  be the Tutte graph with the set of negative vertices of  $T$  as depicted in Figure 4.4. Assume that, with this assignment,  $T$  has a consistent 2-factor  $F$ .

The graph  $T$  can be viewed as a  $K_4$  where three of the four vertices were replaced by copies of the Tutte fragment. By Lemma 4.1.10, all the three edges incident with the central vertex belong to  $F$ , a contradiction.  $\square$

**Corollary 4.1.12.** *Conjecture 4.1.1 is false.*

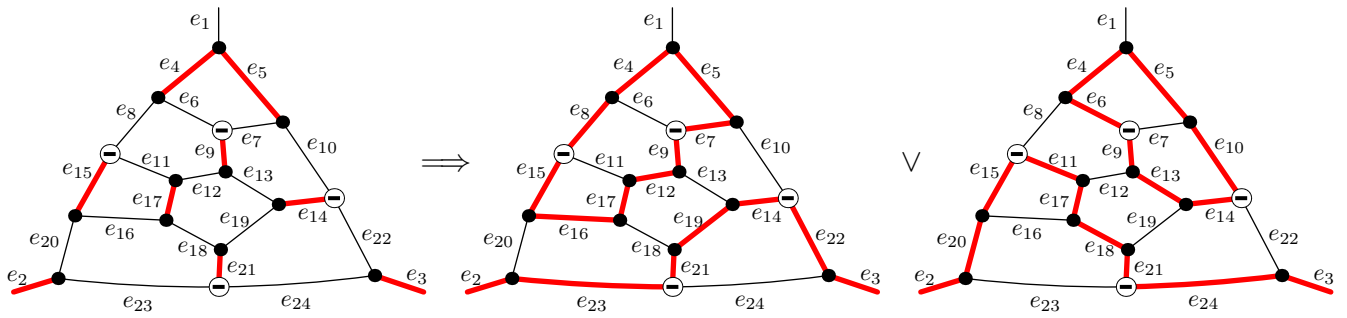

Figure 4.3: In the Tutte fragment with the given position of four negative vertices, for any 2-factor avoiding the edge  $e_1$  there is always at least one cycle containing an odd number of positive vertices.

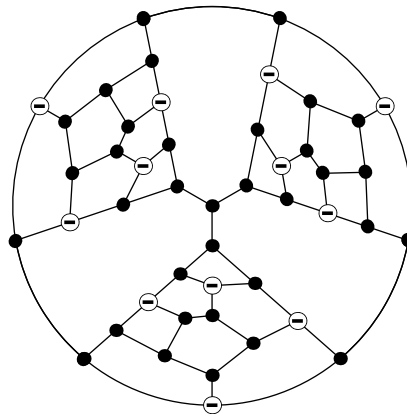

Figure 4.4: The Tutte graph composed of three Tutte fragments.



To find a counterexample, it suffices to consider the Tutte graph  $T$  with a choice of negative vertices as depicted in Figure 4.4 and replace every negative vertex by the graph  $W_3$  depicted in Figure 4.1, and then take the dual. This gives a graph on 61 vertices.

### 4.1.3 Concluding remarks

The question that naturally arises is the size of a minimum non-4-colorable signed planar graph, and this question remains open. Clearly, it suffices to search for a triangulation whose dual is a non-hamiltonian 3-connected cubic planar graph, and then search for a position of an even number of negative vertices such that there is no weak edge labeling of the dual graph.

It is known [HM88] that 3-connected cubic planar graphs on at most 36 vertices are all hamiltonian. There are six smallest non-hamiltonian 3-connected cubic planar graphs on 38 vertices, and for each of them it is possible to choose a position of eight negative vertices such that the graph does not admit a consistent 2-factor, and therefore it does not admit a strong edge labeling. (We omit the details).

To guarantee the non-existence of a weak edge labeling, it suffices to replace four negative vertices by the gadget  $W_3$ , which has 7 vertices. The corresponding graph that does not admit a weak edge labeling then has 74 vertices, which corresponds to a non-4-colorable signed triangulation on 39 vertices, see Figure 4.5. (Again, we omit the details). Hence a minimum counter-example to the conjecture has at least 20 vertices and at most 74.

Another interesting question is the complexity of deciding whether or not a planar signed graph is 4-colorable. It might also be noted that Conjecture 4.1.2 remains a challenging and interesting open question.

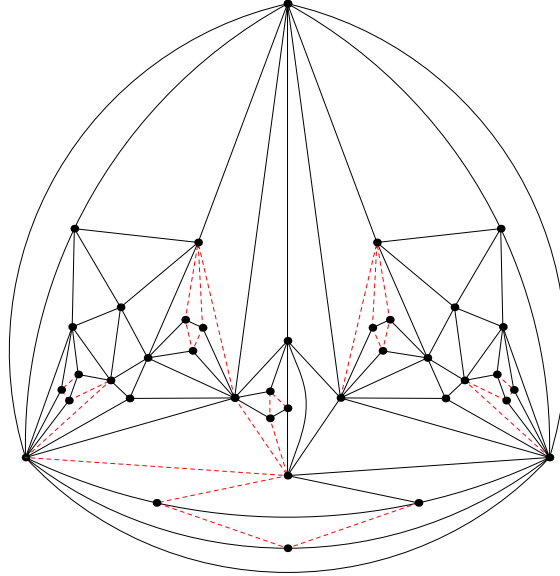

Figure 4.5: The smallest non-4-colorable signed planar graph we have found so far (dashed red lines stand for negative edges).

## 4.2 Towards 4-edge-coloring of triangle-free planar graphs of maximum degree 4

### 4.2.1 Introduction

As previously mentioned in this thesis, one fundamental result on edge-coloring is the seminal result of Vizing [Viz64] from 1964 stating that any graph can be  $(\Delta + 1)$ -edge-colored, where  $\Delta$  is the maximum degree of the graph. Thus, the **chromatic index** of a simple graph  $G$  is either  $\Delta(G)$  or  $\Delta(G) + 1$ . Graphs satisfying  $\chi'(G) = \Delta(G)$  are called of class I, and those with  $\chi'(G) = \Delta + 1$  are called of class II. Regarding **planar graphs**, Vizing[Viz65b] also proved that planar graphs of maximum degree at least 8 are of class I. In the same paper, Vizing also provided constructions of graphs of class II with maximum degree 2, 3, 4, and 5 (see Figure 4.6), and conjectured that all planar graphs of maximum degree at least 6 are of class I.

**Conjecture 4.2.1.** *Every planar graph  $G$  with  $\Delta(G) \geq 6$  is  $\Delta(G)$ -edge-colorable.*

Kronk, Radlowski, and Franen [KRF74] generalized the result of Vizing and proved that planar graphs with maximum degree at least  $d$  and girth at least  $g$  are of class I for  $(g, d) \in \{(3, 8), (4, 5), (5, 4), (8, 3)\}$  (note that a graph of girth 3 is just a simple graph). On the other hand, examples of class II graphs have been found for  $(g, d) \in \{(3, 5), (3, 4), (3, 3), (4, 3), (5, 3)\}$  (see Figure 4.6), which only

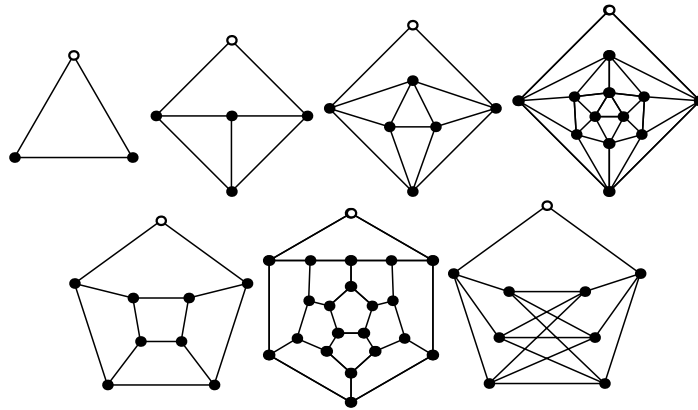

Figure 4.6: Examples of class II graphs of given maximum degree  $d$  can be easily obtained by taking a  $d$ -regular  $d$ -edge-colorable graph and subdividing one edge. For  $d = 2, 3, 4$ , and  $5$ , planar examples can be found starting with a digon or a platonic solid (first row). For  $d = 3$  and given lower bound on girth (4 or 5), again, platonic solids can do the job; for  $d = 4$  and girth 4,  $K_{4,4}$  can be taken for instance (second row).

leaves 5 open cases:  $(3, 7), (3, 6), (4, 4), (6, 3), (7, 3)$ . Sanders and Zhao [SZ01] and independently Zhang [Zha00] proved that planar graphs of maximum degree 7 are also of class I, settling the first case. Recently, Bonduelle and Kardoš [BK21] proved that planar graph with maximum degree 3 and girth at least 7 are also of class I using a computer-assisted method to check the reducibility of configurations, thus leaving only 3 open cases, namely  $(3, 6), (4, 4), (6, 3)$ . A lot of attention has been paid to the case  $(3, 6)$ , see [CCJ<sup>+</sup>19] for a recent and complete survey on edge-coloring on planar graphs. In this section we are interested in the case  $(4, 4)$  and tried to prove the following conjecture.

**Conjecture 4.2.2.** *Triangle-free planar graphs of maximum degree 4 are 4-edge-colorable.*

It should be noted that if this conjecture is true, then it is “almost tight” with respect to the genus of the graph, e.g. there exist class II triangle-free toroidal graphs with maximum degree 4; for instance,  $K_{4,4}$  with a subdivided edge (see Figure 4.6). Therefore, generalizing to other surfaces than the projective plane is hopeless.

Note that throughout this section, whenever we speak about colorings, we always mean proper 4-edge-coloring with color set  $\{1, 2, 3, 4\}$ .

For the sake of simplicity, we will disregard vertices of degrees 0, 1 and 2. Vertices of degree 0 or 1 are reducible, and for vertices of degree 2, one can establish analogous observations and lemmas as for vertices of degree 3.

### 4.2.2 General approach

All of the previous results on related questions are obtained using the discharging method: Configurations of vertices of small degree close to each other are proved to be reducible with respect to an edge-coloring with a given number of edges; then a discharging argument is used to prove that in a graph without any reducible configuration (a potential minimal counterexample) the average degree of vertices is too large for a planar graph of given girth.

In our case, we only have vertices of degree at most 4, and we can derive from Euler's formula that the average degree in a planar graph of girth 4 is less than 4. This means that there are examples of graphs where the vertices of small degree (here small means at most 3) can be arbitrarily far away from each other, with vast areas of the graph filled only with vertices of degree 4.

A computer program was used to search for reducible configurations in this context [GK]. All known reducible configurations are of limited size (at most 9 vertices) and contain at least two small degree vertices. In particular, there is no known reducible configuration containing only one vertex of degree 3. Therefore, there is little hope for a proof of Conjecture 4.2.2 using a discharging argument.

The general idea is a divide and conquer approach. To prove that all triangle-free planar graphs of maximum degree four are 4-colorable, we will try to prove a stronger, Thomassen-like statement, where some edges are already precolored.

Instead of considering planar graphs, we will consider so-called fragments. A *fragment* is a triangle-free 2-connected planar graph with maximum degree 4 with eventual half-edges incident to the outerface of the fragment. The outerface of the fragment  $H$  is called the *border* of  $H$ , and is denoted by  $B(H)$ . Given a fragment  $H$ , our goal is to show that if the half-edges of  $B(H)$  are precolored, and the precoloring satisfies a certain property  $(*)$  (that we will specify later), then the precoloring of the half-edges of  $B(H)$  can be extended to  $H$ .

To prove such a statement, we consider three main cases. Let  $H$  be a fragment. The first case is when  $H$  has a "bottleneck" (*i.e.*, a small *separator*, disjoint from the border, that cuts the graph into at least 2 non-trivial parts). The second case is when  $H$  has a small separator including some border vertices. In both cases we cut the fragment along a cycle or a path  $P$  into two smaller fragments  $H_1$  and  $H_2$ , color the fragment  $H_1$  by induction (actually we extend the precoloring of  $B(H_1) \setminus P$  to the whole fragment  $H_1$ ) in such a way that the precoloring of  $B(H_2)$  satisfy the property  $(*)$ ; by induction this precoloring is extendable to  $H_2$ , and henceforth to the whole fragment  $H$ . Finally, the third case is the generic one, and the approach is to "peel" the fragment face by face starting from the faces closest to the border of the fragment.

Let  $C$  be a cycle in a 2-connected *plane graph*  $G$  inducing a non-self-inter-

secting closed curve embedded in the plane. Then the interior and the exterior of  $C$  are well-defined, and there are two fragments of  $G$  whose border is  $C$ . In particular, if  $G$  is 2-connected, for every inner face  $f$ , its facial cycle  $C$  defines a fragment with a single inner face, which we will also denote by  $f$ .

### 4.2.3 Group labelings and lollipops

Let  $G$  be a graph and let  $\Gamma$  be a group. We fix an **orientation** of the edges of  $G$ . Let  $\varphi : E(G) \rightarrow \Gamma$  be an edge-labeling of  $G$  with elements of  $\Gamma$ . If  $\varphi(uv) = x$ , then  $\varphi(vu) = x^{-1}$ . We can extend the labeling to walks in  $G$  (not necessarily respecting the orientation of the edges) in the natural way:

Let  $w = e_1e_2 \dots e_k$  be a walk in  $G$ . The label of  $w$  is defined as

$$\varphi(w) = \varphi(e_1e_2 \dots e_k) = \varphi(e_1)\varphi(e_2) \dots \varphi(e_k).$$

In particular, for a walk  $w$  of length 0 (no matter what the starting (and ending) vertex is), the label of  $w$  is the neutral element of the group  $\Gamma$ .

Observe that the labeling of walks is compatible with the operations of inversion and concatenation of walks (*i.e.*  $\varphi(w^{-1}) = (\varphi(w))^{-1}$  and  $\varphi(w_1w_2) = \varphi(w_1)\varphi(w_2)$ ), and thus  $\varphi$  can be seen formally as a (restriction of a) homomorphism from the free group generated by  $E(G)$  to  $\Gamma$ .

Let  $G$  be a plane graph and let  $H$  be a fragment in  $G$ . Let  $u$  be a vertex on the boundary of  $H$  or outside  $H$ , and let  $P$  be a path from  $u$  to a vertex  $v$  on the boundary of  $H$  such that the only vertex from  $H$  on  $P$  is  $v$ . (If  $u$  is on the boundary of  $H$ , then  $P$  is a trivial path of length 0.) The *lollipop of  $H$  from  $u$  via  $P$* , denoted by  $L_u^P(H)$ , is the closed walk obtained as a product of three walks: first  $P$ , then the closed walk around  $H$  in the anti-clockwise direction, and finally  $P^{-1}$ . We will omit the path  $P$  if there is no ambiguity.

Observe that the facial closed walk around a face  $f$  (in the anti-clockwise direction) is a special case of a lollipop. We will call it a *trivial lollipop* and denote it by  $L_u^0(f)$ .

**Lemma 4.2.3.** *Let  $G$  be a plane graph and let  $H$  be a fragment in  $G$  with  $t$  inner faces. Let  $u$  be a vertex on the boundary of  $H$  or outside  $H$ , and let  $P$  be a path from  $u$  to a vertex  $v$  on the boundary of  $H$  such that the only vertex from  $H$  on  $P$  is  $v$ . Then there exists an ordering  $f_1, f_2, \dots, f_t$  of the set of inner faces of  $H$  and there exist paths  $P_1, P_2, \dots, P_t$  such that each  $P_i$  starts at  $u$  and contains  $P$  as a prefix, moreover,  $P^{-1}P_i$  does not leave  $H$ , satisfying*

$$L_u^P(H) = L_u^{P_1}(f_1)L_u^{P_2}(f_2) \dots L_u^{P_t}(f_t).$$

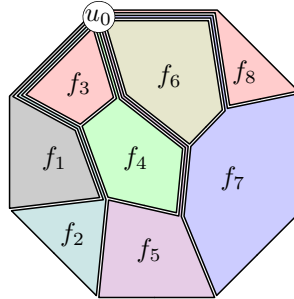

Figure 4.7: The closed walk around a fragment starting and ending at  $u_0$  decomposes into a sequence of lollipops around the faces of the fragment.

*Proof.* The statement is easy-to-see and can be proved by induction, cutting the fragment into two parts. We omit the details. See Figure 4.7 for an illustration.  $\square$

**Corollary 4.2.4** (Lollipop lemma). *Let  $\Gamma$  be a group. Let  $G$  be a plane graph and let  $\varphi$  be a  $\Gamma$ -edge-labeling. Let  $H$  be a fragment in  $G$  with  $t$  inner faces. Let  $u$  be a vertex on the boundary of  $H$  or outside  $H$ , and let  $P$  be a path from  $u$  to a vertex  $v$  on the boundary of  $H$  such that the only vertex from  $H$  on  $P$  is  $v$ . Then there exists an ordering  $f_1, f_2, \dots, f_t$  of the set of inner faces of  $H$  and there exist paths  $P_1, P_2, \dots, P_t$  such that each  $P_i$  starts at  $u$  and contains  $P$  as a prefix, moreover,  $P^{-1}P_i$  does not leave  $H$ , satisfying*

$$\varphi(L_u^P(H)) = \varphi(L_u^{P_1}(f_1))\varphi(L_u^{P_2}(f_2)) \dots \varphi(L_u^{P_t}(f_t)).$$

We will see how the Lollipop lemma can be useful later, when some special labelings will have been defined.

### Medial graph, rotations and reflections

Let  $G$  be a plane graph. Its plane embedding induces, for each vertex, a cyclic ordering of the incident edges. Therefore, for every vertex  $u$  and every edge  $e$  incident with  $u$ , the next and the previous edge (in anticlockwise direction) are well-defined.

Let  $G$  be a plane graph. The medial graph of  $G$ , denoted by  $M(G)$ , is defined in the following way:

- $V(M(G)) = \{(v, e) \in V(G) \times E(G) \mid v \in e\}$ , and

#### 4. From coloring to edge-labeling

---

- $\{(v, e), (v', e')\} \in E(M(G)) \iff (e = e' \text{ and } v \neq v') \text{ or } (v = v' \text{ and } e \text{ and } e' \text{ are consecutive around } v).$

There is a direct geometric interpretation of the medial graph: It can be obtained by *truncation* of all the vertices of  $G$  – replacing each vertex of degree  $d$  by a face of size  $d$ .

Observe that  $M(G)$  is always a cubic plane graph. If  $G$  contains a vertex of degree 1, then  $M(G)$  contains a loop. Similarly, if  $G$  contains a vertex of degree 2, then  $M(G)$  contains a digon. As long as  $G$  is of minimum degree at least 3,  $M(G)$  is a simple graph.

Let  $f$  be a face of  $M(G)$ . Then either  $f$  corresponds to a vertex of  $G$  (and then its size is equal to the degree of the corresponding vertex, we call it a v-face), or  $f$  corresponds to a face of  $G$  (and then its size is twice the size of the corresponding face, we call it an f-face).

It is easy to see that the edge set of  $M(G)$  contains a perfect matching formed by the edges of the first kind (those that correspond to the edges of  $G$ ), each such edge separates two f-faces of  $M(G)$ ; the remaining edges form a 2-factor consisting of the facial cycles of the v-faces, each such edge separates a v-face from an f-face.

Let  $G$  be a 3-connected plane graph and let  $M(G)$  be its medial graph. We fix an orientation of  $M(G)$  in the following way: For the edges of the first kind we choose arbitrarily; for the edges of the second kind we orient the borders of the f-faces in the anti-clockwise direction. In other words,  $((u, e), (u, e'))$  is an oriented edge of  $M(G)$  if and only if  $e'$  is the next edge after  $e$  around  $u$  in  $G$ .

We can now define a labeling of  $M(G)$  using labels from the dihedral group  $D_4$  of order 8. We will denote it  $\varphi_0$  and call it the *base* labeling of  $M(G)$ .

We will represent  $D_4$  as the group of symmetries of a square  $abcd$ , generated by a rotation  $\rho : abcd \mapsto bcda$  and a reflection  $\eta : abcd \mapsto adcb$ . Let  $\tau = \eta\rho : abcd \mapsto dcba$ . (Here the composition of symmetries is defined as  $(\sigma\sigma')(x) = \sigma'(\sigma(x))$ .) Observe that  $\rho^4 = \eta^2 = \tau^2 = 1$  and that  $\eta = \tau\rho^3$ .

Let  $\varphi_0 : E(M(G)) \rightarrow D_4$  be the labeling defined by

$$\varphi_0(e) = \begin{cases} \eta & \text{if } e \text{ is an edge of the first kind,} \\ \rho & \text{if } e \text{ is an edge of the second kind.} \end{cases}$$

As a direct consequence of the definition we get the following formulae for the labels of trivial lollipops.

**Lemma 4.2.5.** *Let  $f$  be a v-face of  $M(G)$  of size  $d$ . Let  $d = 4k + z$  for  $k \in \mathbb{N}_0$  and  $z \in \{0, 1, 2, 3\}$ . Let  $u$  be a vertex incident with  $f$ . Then  $\varphi_0(L_u^0(f)) = \rho^z$ .*

**Lemma 4.2.6.** *Let  $f$  be an  $f$ -face of  $M(G)$  of size  $2d$ . Let  $d = 2k + z$  for  $k \in \mathbb{N}_0$  and  $z \in \{0, 1\}$ . Let  $u$  be a vertex incident with  $f$  such that the facial closed walk around  $f$  starts with an edge of the first kind. Then  $\varphi_0(L_u^0(f)) = \tau^z$ .*

In particular, the base labels of the trivial lollipops of  $v$ -faces corresponding to vertices of  $G$  of degree 4, as well as those of  $f$ -faces corresponding to faces of  $G$  of even size, are equal to 1. The base label of a trivial lollipop of a  $v$ -face corresponding to a vertex of  $G$  of degree 3 is  $\rho^3$ , and the base label of a trivial lollipop (starting with an edge of the first kind) of an  $f$ -face corresponding to a face of  $G$  of odd size is  $\tau$ .

**Lemma 4.2.7.** *Let  $f$  be a  $v$ -face of  $M(G)$  corresponding to a 4-vertex of  $G$ . Then  $\varphi_0(L_u^P(f)) = 1$  for any lollipop of  $f$ .*

**Lemma 4.2.8.** *Let  $f$  be a  $f$ -face of  $M(G)$  corresponding to an even face of  $G$ . Then  $\varphi_0(L_u^P(f)) = 1$  for any lollipop of  $f$ .*

*Proof of both lemmas.* It suffices to observe that

$$\varphi_0(L_u^P(f)) = \varphi_0(P)\varphi_0(L_u^0(f))\varphi_0(P^{-1}) = \varphi_0(P) \cdot 1 \cdot \varphi_0(P)^{-1} = 1.$$

□

**Lemma 4.2.9.** *Let  $f$  be a  $v$ -face of  $M(G)$  corresponding to a 3-vertex of  $G$ . Then  $\varphi_0(L_u^P(f)) = \rho^3$  if the number of the edges of the first kind in  $P$  is even, and  $\varphi_0(L_u^P(f)) = \rho$  if the number of the edges of the first kind in  $P$  is odd.*

*Proof.* By induction on the length of the path  $P$ . It suffices to observe that the conjugate of  $\rho$  by  $\eta$  is  $\rho^3$  and vice versa, and that  $\rho$  and  $\rho^3$  are invariant when conjugated by  $\rho$  or  $\rho^3$ , which is a trivial routine. □

**Lemma 4.2.10.** *Let  $f$  be a  $f$ -face of  $M(G)$  corresponding to an odd face of  $G$ . Then  $\varphi_0(L_u^P(f)) = \tau$  if the length of  $P$  is even, and  $\varphi_0(L_u^P(f)) = \rho^2\tau$  if the length of  $P$  is odd.*

*Proof.* By induction on the length of the path  $P$ . It suffices to observe that the conjugate of  $\tau$  by  $\rho$ ,  $\rho^3$ , or  $\eta$  is  $\rho^2\tau$  and vice versa. □

### Color-labeling of vertices and swap-labeling of edges

Let  $G$  be a 3-connected 4-edge-colorable plane graph with vertices of degrees 3 and 4. We fix a 4-edge-coloring  $\gamma$  of  $G$ . We will define another edge-labeling of  $M(G)$ , denoted by  $\varphi_\gamma$ , and called *swap-labeling* of  $M(G)$ .



As for labels, we will use the elements of the group

$$\begin{aligned}\Omega = \langle 12, 13, 14, 23, 24, 34 \mid & 12^2 = 13^2 = 14^2 = 23^2 = 24^2 = 34^2 = 1, \\ & (12 \cdot 34)^2 = (13 \cdot 24)^2 = (14 \cdot 23)^2 = 1 \\ & (12 \cdot 13 \cdot 23)^2 = (12 \cdot 14 \cdot 24)^2 = \\ & = (13 \cdot 14 \cdot 34)^2 = (23 \cdot 24 \cdot 34)^2 = 1 \rangle.\end{aligned}$$

Note that if  $(xyz)^2 = 1$ , then  $(zyx)^2 = 1$  and also  $(zxy)^2 = (yzx)^2 = 1$ .

Just like for the case of walks and the free group over  $E(G)$ , we will not necessarily use all the elements of  $\Omega$  to label edges, walks, and lollipops in  $M(G)$ .

In order to define  $\varphi_\gamma$ , we need to look at the vertices first. Let us start with a special vertex-labeling of  $M(G)$ , induced by the coloring  $\gamma$ , denoted by  $\phi_\gamma$ , with labels taken from  $S_4$ , the group of permutations of the colors 1, 2, 3, and 4. We will interpret values of  $\phi_\gamma$  as assignments of colors to the vertices of a square; the elements of the base group  $D_4$  will then be interpreted as actions on this square.

Let  $(v, e) \in V(M(G))$  with  $d_G(v) = 4$ . Let  $e = e_1, e_2, e_3, e_4$  be the cyclic order of the edges around  $v$  in  $G$ . Then we set

$$\phi_\gamma((v, e)) = (\gamma(e_1), \gamma(e_2), \gamma(e_3), \gamma(e_4)).$$

Let  $(v, e) \in V(M(G))$  with  $d_G(v) = 3$ . Let  $e = e_1, e_2, e_3$  be the cyclic order of the edges around  $v$  in  $G$ . Let  $c$  be the color missing at  $v$  in  $\gamma$ . Then we set

$$\phi_\gamma((v, e)) = (\gamma(e_1), \gamma(e_2), c, \gamma(e_3)).$$

One can imagine the label of a vertex  $(v, e)$  with  $d_G(v) = 3$  as if we inserted a temporary ghost edge inside the face of  $G$  incident with  $v$  but not with  $e$ , colored with the color that is not used at  $v$ , and then we read the four colors at  $v$  in a cyclic order, starting from  $e$ .

Let  $((v, e), (v, e'))$  be an oriented edge of  $M(G)$  incident to a  $v$ -face corresponding to a 4-vertex  $v$  in  $G$ . (Recall that the edges  $e$  and  $e'$  are consecutive in the cyclic order around  $v$ .) Then, by definition, if  $\phi_\gamma((v, e)) = (a, b, c, d)$ , then  $\phi_\gamma((v, e')) = (b, c, d, a)$ , and so  $\phi_\gamma((v, e')) = \varphi_0(\phi_\gamma((v, e)))$ . In this case, we set

$$\varphi_\gamma(((v, e), (v, e')))) = 1.$$

Let  $((v, e), (v, e'))$  be an oriented edge of  $M(G)$  incident to a  $v$ -face corresponding to a 3-vertex  $v$  in  $G$ . Then, by definition, if  $\phi_\gamma((v, e)) = (a, b, c, d)$ , then we know that  $c$  is the missing color at  $v$ , and so  $\phi_\gamma((v, e')) = (b, d, c, a)$ , whereas  $\varphi_0(\phi_\gamma((v, e))) = (b, c, d, a)$ . In this case, we set

$$\varphi_\gamma(((v, e), (v, e')))) = cd$$

since a swap of colors  $c$  and  $d$  is needed to transform  $\varphi_0(\phi_\gamma((v, e)))$  into  $\phi_\gamma((v, e'))$ .

Let  $((u, e), (v, e))$  be an edge of  $M(G)$  of the second kind, with  $e = \{u, v\} \in E(G)$ . Without loss of generality we may assume that  $\phi_\gamma((u, e)) = (1, 2, 3, 4)$ . Then we set

$$\varphi_\gamma(((u, e), (v, e))) = \begin{cases} 1 & \text{if } \phi_\gamma((v, e)) = (1, 4, 3, 2), \\ 23 & \text{if } \phi_\gamma((v, e)) = (1, 4, 2, 3), \\ 34 & \text{if } \phi_\gamma((v, e)) = (1, 3, 4, 2), \\ 23 \cdot 24 & \text{if } \phi_\gamma((v, e)) = (1, 2, 4, 3), \\ 34 \cdot 24 & \text{if } \phi_\gamma((v, e)) = (1, 3, 2, 4), \\ 23 \cdot 24 \cdot 34 = 34 \cdot 24 \cdot 23 & \text{if } \phi_\gamma((v, e)) = (1, 2, 3, 4). \end{cases}$$

Here again, if we applied  $\varphi_0$ , we would obtain  $(1, 4, 3, 2)$ ;  $\varphi_\gamma(((u, e), (v, e)))$  is a sequence of swaps of cyclically adjacent pairs of colors needed to transform  $\varphi_0(\phi_\gamma((u, e)))$  into  $\phi_\gamma((v, e))$ . Observe that  $\varphi_\gamma(((u, e), (v, e)))^{-1}$  is a sequence of swaps of cyclically adjacent pairs of colors needed to transform  $\varphi_0(\phi_\gamma((v, e)))$  into  $\phi_\gamma((u, e))$ , and so the choice of orientation for the edges of the second type is irrelevant and the labeling is well-defined.

Altogether, for any walk  $w$  from  $u$  to  $v$  in  $M(G)$ , we can interpret both labelings  $\varphi_0$  and  $\varphi_\gamma$  as actions on a square with labeled vertices, executed simultaneously. The initial labels of the square correspond to  $\phi_\gamma(u)$ ; the final labels of the square correspond to  $\phi_\gamma(v)$ . Values of  $\varphi_0$  correspond to geometric transformation of the square (rotation, reflection), whereas values of  $\varphi_\sigma$  correspond to relabeling of pairs of adjacent vertices of the square.

It is important to observe that for any edge  $xy \in M(G)$ , we have

$$\varphi_\gamma(\varphi_0(\phi_\gamma(x))) = \phi_\gamma(y) = \varphi_0(\varphi_\gamma(\phi_\gamma(x))). \quad (4.3)$$

Moreover, in general, we obtain the same result if we first perform all the changes of the labels of the vertices of the square and then apply all the geometric transformations, and if we first apply all the geometric transformations and then we perform all the changes of the labels of the vertices. Therefore, we can treat separately the base labeling  $\varphi_0$  and the swap-labeling  $\varphi_\gamma$ , or we can also consider them simultaneously.

**Lemma 4.2.11.** *Let  $L_u(H)$  be a lollipop in  $M(G)$ . Then  $\varphi_\gamma(L_u(H))$ , interpreted as a sequence of relabeling of adjacent pairs of vertices of a labeled square, is well-defined. Moreover,*

$$\varphi_\gamma(L_u(H))(\phi_\gamma(u)) \cdot \varphi_0(L_u(H))(\phi_\gamma(u)) = \phi_\gamma(u).$$

*Proof.* The first part follows from the equation (4.3). The value of  $\phi_\gamma(u)$  is both the initial and the final labeling of the square. In the formula, the first term should be interpreted as a relabeling of the vertices of a labeled square, whereas the second is a geometric transformation from  $D_4$ ; the formula says that these two actions compensate each other.  $\square$

As a direct consequence of lemma 4.2.11 we get that the effect of  $\varphi_\gamma(L_u(H))$  on a labeled square only depends on the graph  $H$  itself, it is invariant and does not depend on  $\gamma$ . However, we will see in the sequel that it is possible to obtain the same final position of the labels in substantially different ways, some of them possibly yielded by a coloring, others surely not.

### Swap lines

We will now explain how the swap-labeling  $\varphi_\gamma$  of  $M(G)$  generated by a coloring  $\gamma$  of  $G$  can be interpreted as a special kind of labeling, resembling a flow, in  $G$ . We will denote it  $\Omega_\gamma$  and we will call its elements *swap words*.

Observe that edges carrying non-trivial values of  $\varphi_\gamma$  are either edges of the first kind around a  $v$ -face of  $M(G)$  of size three, or edges of the second kind.

For an edge  $((u, e), (v, e))$  of the second kind, we interpret the values of  $\varphi_\gamma(((u, e), (v, e)))$  directly as a flow on the edge dual to the edge  $e = \{uv\}$  of  $G$ , as in Figure 4.8.

Observe that if  $\varphi_\gamma$  is a swap word of length two in  $\Omega$  (such as  $23 \cdot 24$  for instance), then the order of its elements must be respected; for the swap words of length three (such as  $23 \cdot 24 \cdot 34 = 34 \cdot 24 \cdot 23$  for instance), we will use any of the two canonical ways of writing them, such that the pair of colors that are not cyclically adjacent at either endvertex of the edge comes in the middle of the triple.

Edges of the first kind carry non-trivial values of  $\varphi_\gamma$  only around  $v$ -faces corresponding to the vertices of degree 3 in  $G$ . In this case, the three edges are labeled  $ab$ ,  $ac$ , and  $ad$  in a certain order, where  $a$  is the color missing at the corresponding vertex in  $G$ . We interpret this in  $G$  as if the vertex of degree 3 emitted the flow of  $ab$ ,  $ac$ , and  $ad$  into the three incident faces.

Let  $G^\square$  denote the infinite square grid. There is a canonical coloring of  $G^\square$  where the vertical edges are alternatively colored 1 and 3, and the horizontal edges 2 and 4 in such a way that every face is 2-colored. Observe that this kind of coloring induces no swap lines at all. The graph  $G^\square$  is bipartite; in a canonical coloring, the cyclic order of colors around vertices of one part is 1, 2, 3, 4, and it is 4, 3, 2, 1 in the other.

It is easy to see that if one chooses one vertical color, say 1, and one horizontal color, say 2, then the Kempe components are simply facial 4-cycles. One can

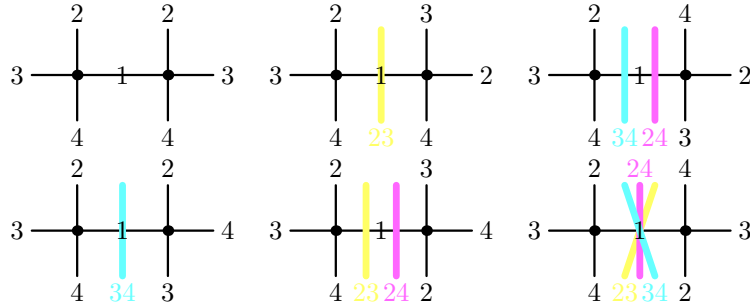

Figure 4.8: For an edge of a given color (here 1), if we fix the three remaining colors at one incident vertex (the left one), there are six possible permutations of these colors at the other incident vertex: Here we list them all and illustrate the corresponding swap-labeling in  $M(G)$ , interpreted here as an  $\Omega$ -flow in  $G^*$ .

choose a set of them and swap the colors 1 and 2 in them. For the new coloring obtained this way, the labeling  $\Omega_\gamma$  only contains the value 12, present precisely on the edges that form an edge-cut separating the swapped components (vertices where the cyclic order of the colors is 2, 1, 3, 4 and 4, 3, 1, 2, respectively) from the rest of the graph (vertices where the cyclic order of the colors is 1, 2, 3, 4 and 4, 3, 2, 1, respectively). In the dual, such an edge-cut corresponds to an even subgraph – a collection of cycles. This is where the motivation for the name ‘swap lines’ comes from.

It can be proved that any coloring of  $G^\square$  is Kempe-equivalent to a canonical one via a countable (not necessarily finite) sequence of Kempe swaps.

**Lemma 4.2.12** (Parity lemma). *Let  $f$  be a face in  $G$ , and let  $a$  and  $b$  be two colors. Then the parity of the sum of the number of edges around  $f$  such that  $\Omega_\gamma(e)$  contains  $ab$ , and the number of 3-vertices emitting  $ab$  into  $f$ , is equal to the parity of  $f$ .*

*Proof.* For every vertex  $u$  around  $f$ , we consider the quadruple  $\xi(v)$  of the colors at  $u$  in the anti-clockwise order, starting with the edge joining  $u$  to the previous one, and ending with the edge to the next one.

If  $u$  is a vertex of degree 3, we insert temporarily the missing color after the first one or before the last one, just as in  $\phi_\gamma$ .

We can partition all the vertices into two sets: Let  $P$  be the set of vertices where  $a$  precedes  $b$  in  $\xi(v)$ , let  $N$  be the set of vertices where  $a$  comes after  $b$  in  $\xi(v)$ .

For two consecutive vertices  $u$  and  $v$ , we have  $u \in P$  and  $v \in N$  or  $u \in N$  and  $v \in P$  an even number of times. Therefore, the parity of the number of pairs  $u, v$  such that either both  $u, v \in P$  or both  $u, v \in N$  is the same as the parity of  $f$ .

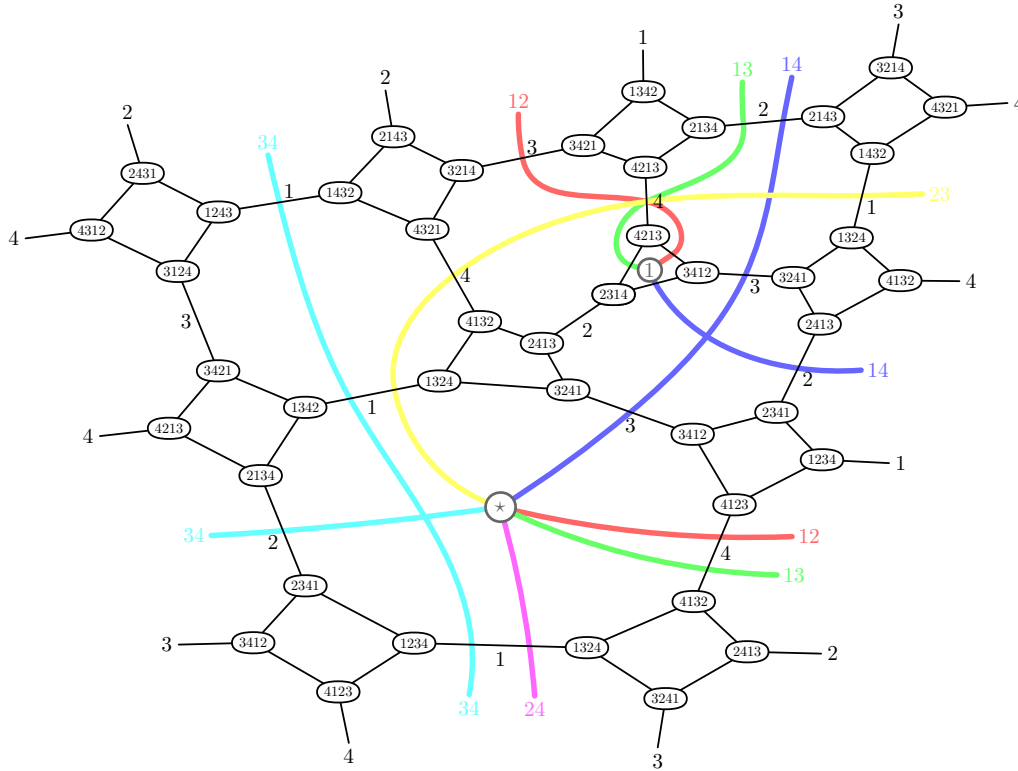

Figure 4.9: An example of the medial graph of a fragment containing one pentagonal face and one vertex of degree 3, with the swap lines interpreted as flow in the dual graph. Observe that the vertex of degree 3 is a source of three swap lines, whereas the face of size 5 is a source of six swap lines.

Let  $uv$  be such a pair. Then  $\varphi_\gamma(uv)$  contains  $ab$ , because, in order to swap the relative position of the colors  $a$  and  $b$  from  $\varphi_0(\phi_\gamma((u, e)))$  to  $\phi_\gamma((v, e))$ , a swap of  $a$  and  $b$  is necessary.

If  $v$  is a vertex of degree 3, then  $\xi(v)$  is different when considering  $v$  and the previous vertex, and when considering  $v$  and the next vertex, where the difference is exactly a swap of  $a$  and  $b$ . This corresponds to the swap line  $ab$  emitted from  $v$ .  $\square$

As a consequence of Lemma 4.2.12, we have that for a face of even (resp. odd) size, the swap word  $\Omega_\gamma(L_u^0(f))$ , decomposed into elementary swaps, contains an even (resp. odd) number of each swap.

Therefore, we can consider each face of odd size as if it emitted one swap line in each of the six possible pairs of colors. On the other hand, even faces (just like vertices of degree 4), do not emit any swap lines. See Figure 4.9 for an illustration.

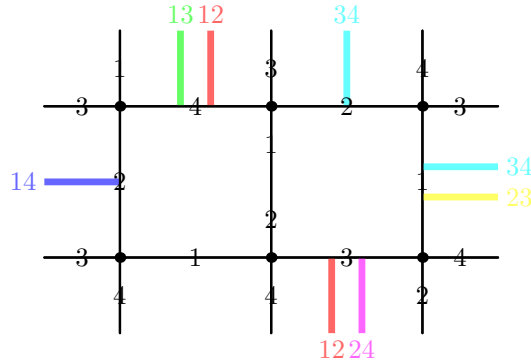

Figure 4.10: The border coloring does not extend, since inside the fragment there are no sources of swap lines, and the border is crossed by an odd number of swap lines of certain types.

Parity lemma is the first (and trivial) necessary condition for a border coloring to be extendable inside a fragment. For instance, the border coloring depicted in Figure 4.10 does not satisfy Parity lemma, and therefore, is not extendable.

On the other hand, Parity lemma is not a sufficient condition: There are examples of fragments such that there are even number of swap lines of each type entering into a fragment containing no sources, however, the coloring does not extend, see Figure 4.11.

### Swap words and Evolution

Consider a lollipop  $L_u^P(H)$  of a fragment  $H$  in a 2-connected 4-edge-colorable plane graph  $G$  with a fixed 4-edge-coloring  $\gamma$ . Then, by Lemma 4.2.11, the swap word  $\Omega_\gamma(L_u^P(H))$  is an element of  $\Omega$  and can be interpreted as a sequence of elementary swaps that the square colored  $\phi_\gamma(u)$  can undergo, in order to compensate the transformation  $\varphi_0(L_u^P(H))$ .

We can look at this sequence more precisely. For a fixed initial cyclic position of the colors (determined by  $\phi_\gamma(u)$ ), each swap of the swap word has the following property: Before and after its application, the two colors concerned are cyclically adjacent, and so one of them moves by one step in one direction and the other one moves by one step in the opposite direction. Therefore, we can trace the trajectory of each color, regardless of the rotations and reflections given by  $\varphi_0$ , to see the overall global effect of  $\Omega_\gamma$  on each color.

Let  $\epsilon_1 = (1, 0, 0, 0)$ ,  $\epsilon_2 = (0, 1, 0, 0)$ ,  $\epsilon_3 = (0, 0, 1, 0)$ ,  $\epsilon_4 = (0, 0, 0, 1)$ . For a pair of colors  $i$  and  $j$  ( $i \neq j$ ), let  $\delta_{i,j} = \epsilon_i - \epsilon_j$ .

**Definition 4.2.13.** Let  $w$  be a walk from  $u$  to  $v$  in a 4-edge-colored graph  $G$ . Let  $\Omega_\gamma(w)$  be the swap word of the walk  $w$ . Let  $\phi_\gamma(u)$  be the quadruple of colors around

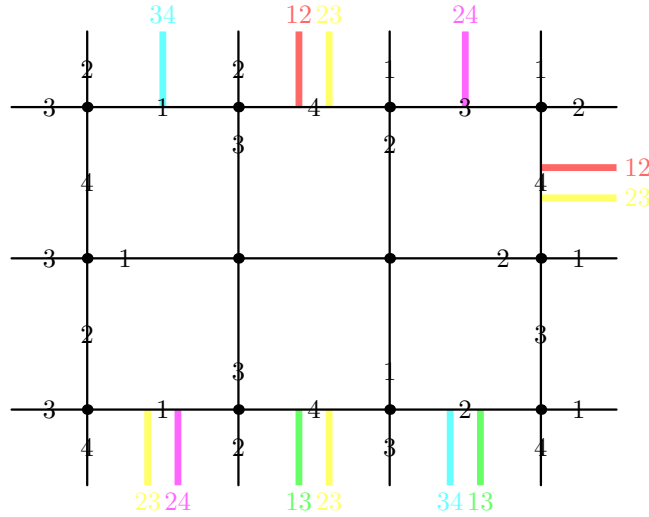

Figure 4.11: Even though the Parity lemma holds, the border coloring does not extend inside the fragment.

$u$ , starting from the first edge of the walk  $w$ . The evolution  $\omega$  of the colors  $\phi_\gamma(u)$  is a quadruple of integers equal to  $\omega(\Omega_\gamma(w))$ , where  $\omega(\Psi)$  is defined as follows:

$$\omega(\Psi) = \begin{cases} (0, 0, 0, 0) & \text{if } \Psi = 1, \\ \omega_\gamma(\Psi') + \delta_{ij} & \text{if } \Psi = \Psi' \cdot (ij), \end{cases}$$

where after applying  $\Psi'$  on  $\phi_\gamma(u)$ , the color  $i$  precedes  $j$  in the cyclic order.

Observe that the evolution can also be interpreted as just another group labeling of  $G$ , this time with the additive group  $\{(a_1, a_2, a_3, a_4) \in \mathbb{Z}^4 \mid a_1 + a_2 + a_3 + a_4 = 0\}$ .

We can now look at the evolution of the swap words of the lollipop of faces and vertices of a graph, in order to establish a lollipop lemma for evolution.

**Lemma 4.2.14.** *Let  $G$  be a 4-edge-colored graph and let  $v$  be a vertex of degree 4 in  $G$ . Then for every lollipop  $L(v)$  (considered as contraction of a lollipop of the corresponding  $v$ -face in  $M(G)$ ) we have  $\omega(\Omega_\gamma(L(v))) = (0, 0, 0, 0)$ .*

*Proof.* It follows from the definition that for a trivial lollipop,  $\Omega_\gamma(L_0(v))$  is the empty word. (Observe that also Lemma 4.2.7 says that  $\Omega_\gamma(L(v))$  does not shuffle the corners of the labeled square.) For lippops with a nontrivial path  $P$  the property can be proved by induction on the length of  $\Omega_\gamma(P)$ : the effects of  $P$  and  $P^{-1}$  cancel each other.  $\square$

**Lemma 4.2.15.** *Let  $G$  be a 4-edge-colored graph and let  $v$  be a vertex of degree 3 in  $G$ . Let  $L_u^P(v)$  be a lollipop of  $v$  from  $u$ ; let  $t$  be the length of the path  $P$ . Let  $i$  be the color missing at  $v$ . Then  $\omega(\Omega_\gamma(L_u^P(v))) = (-1)^t \cdot ((-1, -1, -1, -1) + 4\epsilon_i)$ .*

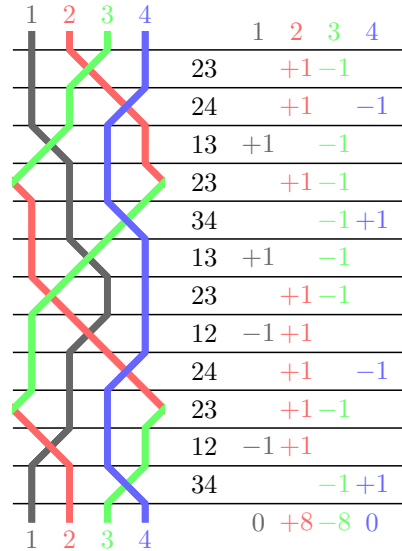

Figure 4.12: An example of a calculation of the evolution of a fragment from Figure 4.11.

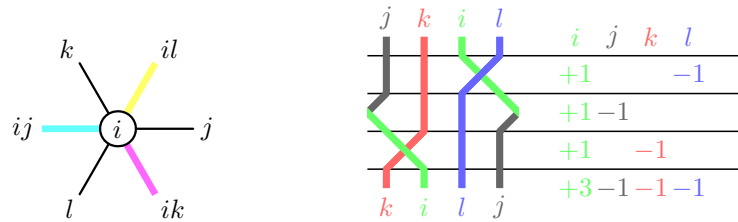

Figure 4.13: A vertex of degree 3 with the missing color  $i$  emits three swap lines  $il$ ,  $ij$ , and  $ik$  (left). The evolution of a trivial lollipop calculated (right).

*Proof.* Consider first a trivial lollipop of  $v$ . Let  $j, k, l$  be the colors of the edge incident with  $v$  in the anticlockwise order. Then, by definition,  $\Omega_\gamma(L_0(v)) = il \cdot ij \cdot ik$ , from which the claim follows immediately, see Figure 4.13 for an illustration.

For lollipops with a nontrivial path  $P$  the property can be proved by induction, in parallel on the length of  $P$  and on the length of  $\Omega_\gamma(P)$ : When an edge is added to  $P$  (without any swap lines), then the orientation of the cyclic order of the colors around the initial vertex switches from anticlockwise to clockwise: All elements of the evolution are multiplied by  $-1$ . When a swap line is added, then two colors are swapped before and after, and these two swaps compensate each other, so the evolution does not change. See Figure 4.14 for an illustration.  $\square$



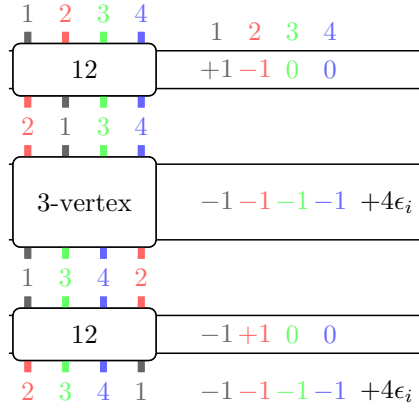

Figure 4.14: The evolution of a lollipop of a vertex  $v$  of degree 3 remains invariant even when a swap line the starting point  $u$  from  $v$ : first, two colors are swapped, then all the colors are rotated,  $4\epsilon_i$  (with  $i$  being the color missing at the  $v$ ) compensating the rotation, and finally the swapped colors are swapped back.

**Lemma 4.2.16.** *Let  $G$  be a 4-edge-colored graph and let  $f$  be a face of even size. Then for every lollipop  $L(f)$  of  $f$ ,  $\omega(\Omega_\gamma(L(f))) = (0, 0, 0, 0)$ .*

*Proof.* Just like in the lemma about vertices of degree 4, it suffices to prove the property for trivial lollipops. Let  $i$  be one of the colors. We consider its relative position at the vertices of  $f$ , in the anticlockwise order around  $f$ . For each pair of consecutive vertices, we inspect how the evolution of  $i$  can be increased or decreased when passing from a vertex to the next one. All such transitions are depicted in Figure 4.15. It is crucial to observe that the evolution of the color is determined uniquely by the parity of the distance and the relative position of the color at a vertex at this distance. Therefore, since the initial and final position of a color at a vertex is identical and these two are at even distance along  $f$ , the evolution of  $i$  has to be equal to 0, whatever the initial position of  $i$  is.  $\square$

**Lemma 4.2.17.** *Let  $G$  be a 4-edge-colored graph and let  $f$  be a face of odd size. Then for every trivial lollipop  $L(f)$  of  $f$ ,  $\omega(\Omega_\gamma(L(f))) = (3, 1, -1, -3)$ , where the colors are taken around a vertex incident with  $f$  in the anticlockwise order, starting and ending with edges incident with  $f$ .*

**Lemma 4.2.18.** *Let  $G$  be a 4-edge-colored graph and let  $f$  be a face of odd size. Then for every lollipop  $L_u^P(f)$  of  $f$ ,  $\omega(\Omega_\gamma(L_u^P(f))) \equiv (3, 1, -1, -3) \pmod{8}$ , where the colors are taken around  $u$  in the anticlockwise order, starting and ending with edges that would correspond to the edges incident with  $f$  if only  $\tau$  was applied along  $P$ , ignoring the swap lines.*

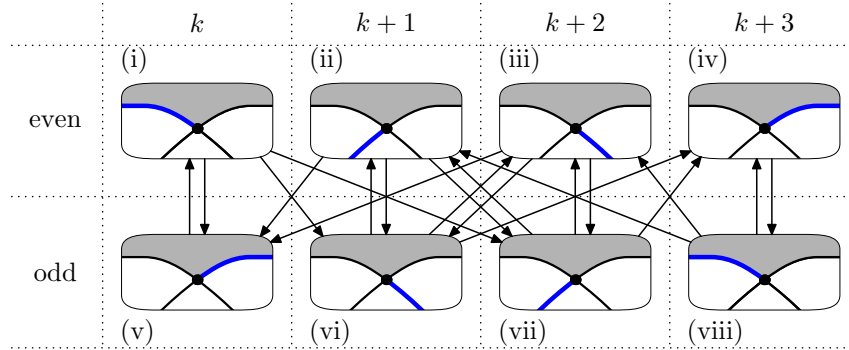

Figure 4.15: A graphical representation of all the possible states of a vertex, with respect to a fixed color (here blue) and the parity of its order taken anticlockwise around a given face (here represented as the grey region). The two rows represent the vertices in even and odd distance respectively, and the values  $k$  up to  $k + 3$  represent the evolution of the fixed color. All the possible transitions among the states (when moving from a vertex to the next one) are represented by arrows.

*Proof.* By induction, in parallel on the length of  $P$  and on the length of  $\Omega_\gamma(P)$ . If an edge is added to  $P$ , then  $\tau$  reverses the order of the colors ( $abcd$  becomes  $dcb$ ) and hence also switches the orientation from anticlockwise to clockwise and vice versa. However, by reversing the order of  $(3, 1, -1, -3)$  we get  $(-3, -1, 1, 3)$ , which we should multiply by  $-1$  to switch the meaning of positive and negative – we get  $(3, 1, -1, -3)$  again.

If a swap line is added, then we distinguish four cases, depending on which two cyclically consecutive colors are swapped. In three of the four cases, this has no effect on the evolution, and in the fourth one, one color gains  $+8$  and another gains  $-8$  of evolution, See Figure 4.16.  $\square$

We are now ready to explain how to establish a necessary condition on the boundary coloring to be extendable into the interior of a fragment.

As a direct consequence of Lollipop lemma we have the following

**Theorem 4.2.19** (Lollipop lemma for evolution). *Let  $G$  be a plane graph and let  $\varphi$  be a  $\Gamma$ -edge-labeling. Let  $H$  be a fragment in  $G$  with  $t$  inner faces. Let  $u$  be a vertex on the boundary of  $H$  or outside  $H$ , and let  $P$  be a path from  $u$  to a vertex  $v$  on the boundary of  $H$  such that the only vertex from  $H$  on  $P$  is  $v$ . Then there exists an ordering  $f_1, f_2, \dots, f_t$  of the set of inner faces of  $H$  and there exist paths  $P_1, P_2, \dots, P_t$  such that each  $P_i$  starts at  $u$  and contains  $P$  as a subpath, moreover,  $P^{-1}P_i$  does not leave  $H$ , satisfying*

$$\omega(L_u^P(H)) = \omega(L_u^{P_1}(f_1)) + \omega(L_u^{P_2}(f_2)) + \dots + \omega(L_u^{P_t}(f_t)). \quad (4.4)$$

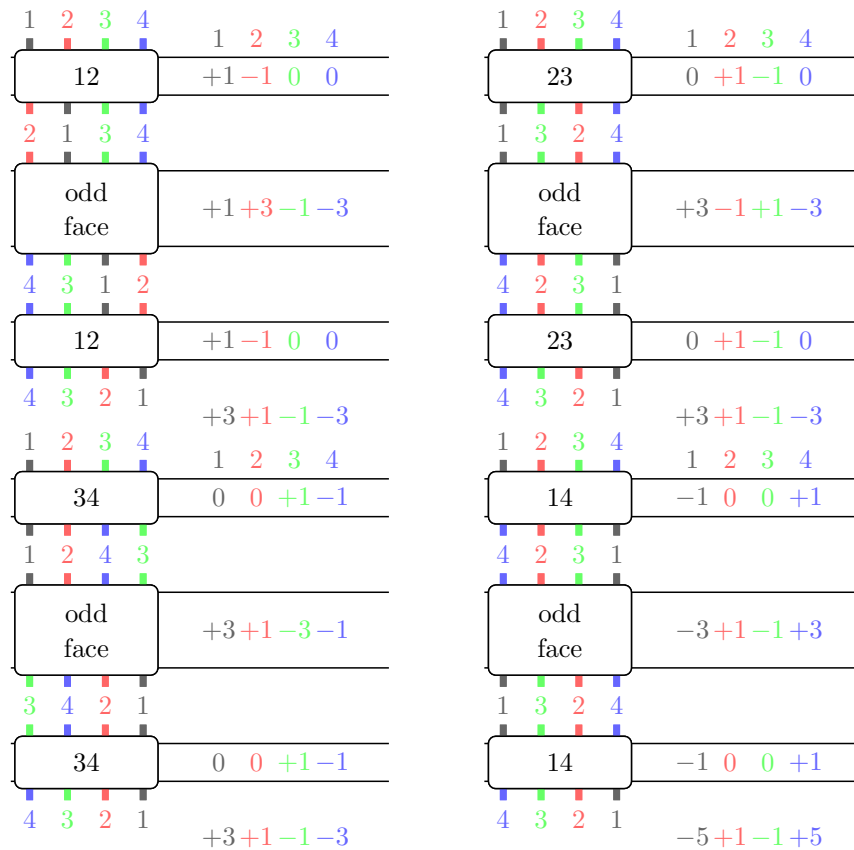

Figure 4.16: When the evolution of an odd face is conjugated, then either it does not change at all, or two of its components gain  $+8$  and  $-8$  respectively. We consider an odd face in such a position that the four colors (read from left to right) evolve by  $(3, 1, -1, -3)$ . Observe that these four roles can be played by various quadruples of colors.

On the left-hand side of the equality (4.4) we have the evolution of the fragment, which can be calculated given the coloring of the border, without knowing whether (and how) the coloring extends inside the fragment.

On the other hand, on the right-hand side of the equality (4.4), only evolutions of odd faces and vertices of degree 3 participate in a non-trivial way. The evolution of an odd face is determined by its position relative to the starting point, and is known up to modulo 8, regardless of the coloring. The evolution of a vertex of degree 3 is also determined by its position relative to the starting point, and has only four possible values, depending on the missing color at that vertex.

#### 4.2.4 Partial results

We will now expose a few examples where Theorem 4.2.19 can serve as a necessary condition for a border coloring to be extendable into the interior of a fragment.

The first example is the fragment depicted in Figure 4.11, whose evolution is calculated in Figure 4.12. It is easy to see that the sum of evolutions on the right-hand side is equal to  $(0, 0, 0, 0)$ , whereas the evolution of the fragment is equal to  $(0, +8, -8, 0)$ . Therefore, the coloring does not extend.

The second example is the fragment  $H$  depicted in Figure 4.17. Let  $u$  be the lower-left corner of  $H$ . We have

$$\omega(L_u(H)) = (+3, +1, -1, -3)$$

– this can be calculated by applying the swaps  $\Omega_\gamma(L_u(H)) = 34 \cdot 12 \cdot 14 \cdot 13 \cdot 24 \cdot 23$  on  $\phi_\gamma(u) = (1, 2, 3, 4)$ . On the other hand,

$$\omega(L_u^{P_1}(f_1)) + \omega(L_u^{P_2}(f_2)) + \cdots + \omega(L_u^{P_t}(f_t)) = (-1, -3, +3, +1) \pmod{8}$$

as the Figure 4.17(right) explains. These two vectors cannot be equal, and so the coloring does not extend.

The third example is the fragment depicted in Figure 4.18, left. We have

$$\omega(L_u(H)) = (0, +2, 0, -2).$$

On the right-hand side of the equality (4.4), one odd face and one vertex of degree 3 participate. The sum of their evolutions is

$$(+1, +1, +1, +1) - 4\epsilon_i + (-1, -3, +3, +1) \equiv (0, -2, +4, +2) - 4\epsilon_i \pmod{8}.$$

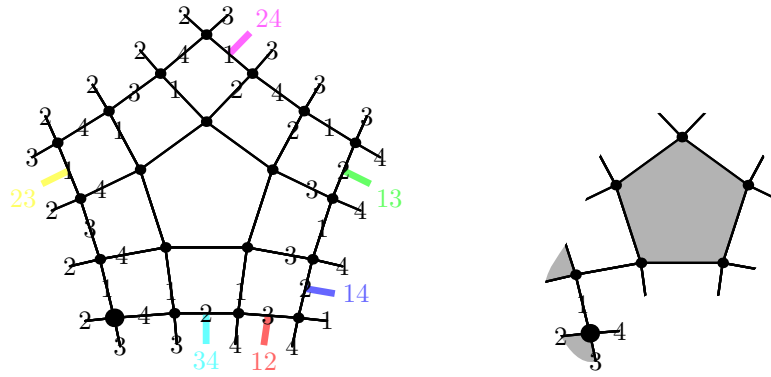

Figure 4.17: An example of a fragment containing a single odd face, with a border coloring (left). A path from the lower-left corner to the odd face, used to calculate the evolution of the face (right). Shaded are the faces that correspond to the orbit of the odd face with respect to  $\tau$  along the path. Hence, the evolution of the lollipop of the pentagon is a rotation of  $(+3, +1, -1, -3)$ , where the colors play these roles in the order 3, 4, 1, 2.

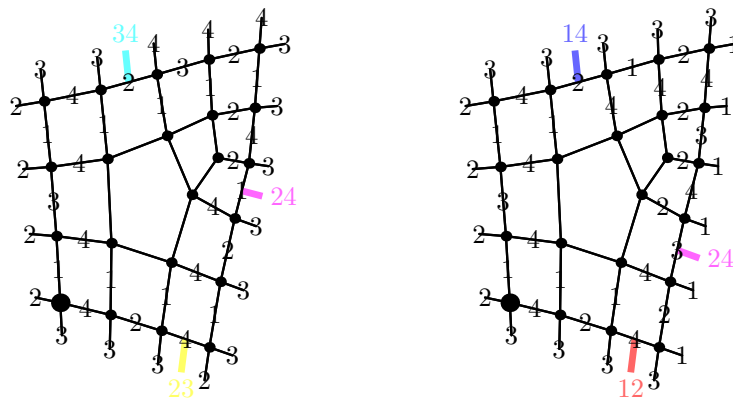

Figure 4.18: An example of a fragment with one odd face and one vertex of degree 3, and two different border colorings. The one on the left is not extendable, whereas the one on the right is. Observe that for both of them the Parity lemma is satisfied.

It is easy to see that the equality cannot be satisfied for any choice of the color  $i$  missing at the vertex of degree 3.

The fourth example is the fragment depicted in Figure 4.18, right. This time, we have

$$\omega(L_u(H)) = (0, -2, 0, +2).$$

On the right-hand side of the equality (4.4), one odd face and one vertex of degree 3 participate again. The sum of their evolutions is

$$(+1, +1, +1, +1) - 4\epsilon_i + (-1, -3, +3, +1) \equiv (0, -2, +4, +2) - 4\epsilon_i \pmod{8}.$$

The equality is only possible if  $i = 3$ , we know thus that the color missing at the vertex of degree 3 must be equal to 3. It is easy to see that the coloring is extendable.

The final example is the fragment depicted in Figure 4.19. Here we have

$$\omega(L_u(H)) = (+8, +6, -8, -6).$$

On the right-hand side of the equality (4.4), we have

$$(+1, +1, +1, +1) - 4\epsilon_i + (-1, -3, +3, +1) \equiv (0, -2, +4, +2) - 4\epsilon_i \pmod{8}.$$

The equality is only possible if  $i = 3$ , we know thus that the color missing at the vertex of degree 3 must be equal to 3. Moreover, the evolution of the pentagonal face must then be equal to  $(+7, +5, -5, -7) = (-1, -3, +3, +1) + (+8, +8, -8, -8)$ , and so the evolution of the trivial lollipop is conjugated in a way that adds  $+8$  and  $-8$  somewhere repeatedly. To do this twice, we need to permute the colors after the first time in such a way that a different pair occupies the position which induces this change. Altogether, the starting vertex must be separated from the pentagon by at least four swap lines. All of this is possible, see Figure 4.19, right.

There is another coloring of the border of the same fragment, with the same swap word and thus the same evolution – only the position of two swap lines is modified, see Figure 4.20. Again, all the reasoning from the previous paragraph applies. In this case, there is not enough room inside the fragment to make everything work. We would need to add some "buffer space" to reroute the swap lines in order to make the coloring work.

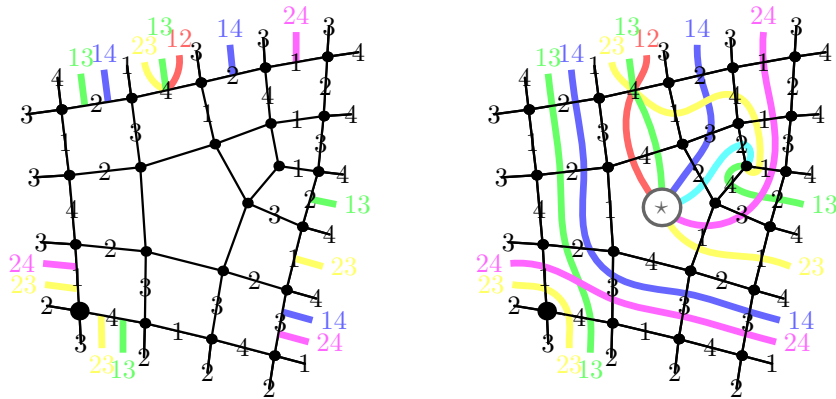

Figure 4.19: Another coloring of the border of the fragment from the previous figure (left). It extends to a coloring of the whole fragment (right).

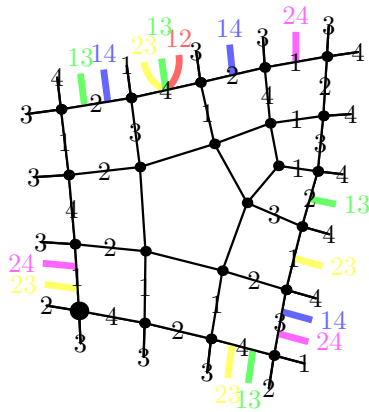

Figure 4.20: Yet another coloring of the border of the fragment from the previous figure. Despite having the same evolution as the previous one, it does not extend to a coloring of the whole fragment.

4.2. Towards 4-edge-coloring of triangle-free planar graphs of maximum degree 4



## Concluding remarks

In this thesis, we studied some recoloring problems (mainly edge-recoloring problems), and some other coloring problems using computer assisted techniques and reduction to edge-labeling. To conclude this work, let us recall our main results, and discuss some open questions and future work.

Regarding edge-coloring reconfiguration, and in particular regarding greedy connected edge-coloring, we prove in Section 3.2 that  $\chi'_c(G) = \chi'(G)$  for sub-cubic graphs using a Kempe recoloring argument. This argument has been generalized in the context of vertex-coloring to perfect graphs by Beaudou et al. [BBD<sup>+</sup>21]. Generalizing it to edge-coloring of graphs with a bigger maximum degree (and is particular generalizing the “reachability lemma” argument) seems an interesting question, and there is no obvious obstruction to this generalization. Regarding the reconfiguration version of the Hadwiger’s conjecture: every  $K_t$ -minor free graph has all its  $t$ -coloring equivalent. We disprove, using a probabilistic argument, the conjecture of Meyniel and Las Vergas. As mentioned in this section, every graph that admits quasi- $K_{2t}$ -minor admits a  $K_t$ -minor, however the infimum value of a constant  $c$  such that the existence of a quasi- $K_{ct}$ -minor guarantees the existence of a  $K_t$ -minor is still unclear and is an interesting question to investigate.

In Chapter 4, we first disprove a conjecture on signed graphs that generalizes the four-color theorem.

**Conjecture** ([MRŠ16]). *Every signed planar graph is 4-signed-colorable.*

Therefore, there remains little hope to generalize the four-color theorem (and thus, finding a more understandable proof of it) using signed coloring of signed graphs. However, the weak-choosability conjecture, that states that all planar graphs are 4-weak-choosable (and which has been proved to be implied by the conjecture on signed planar graphs by Zhu [Zhu20]) may be a fruitful approach towards a better understanding of the four-color theorem.

We then present our work toward the 4-edge-colorability of triangle-free planar graphs with maximum degree 4. During my PhD, we were not able to reach a conclusion to this question, however, our approach seems promising. We hope

that using the lollipop decomposition, and strengthening the necessary condition on the partial coloring of the border of a fragment may be sufficient to prove the conjecture. Again, a reduction to edge-labeling of an auxiliary graph was used to reach those partial results and we think that pushing further the method could lead to some improvement regarding this question.

The main result of this manuscript is obviously our result on Vizing's edge-coloring conjecture. In Chapter 2, we prove the conjecture for simple graphs (first in the case of triangle-free graphs, then in the general case). Vizing's though proved that his result can be extended to multigraphs.

**Theorem** ([Viz65a]). *For any multigraph  $G$ ,  $\chi'(G) \leq \Delta(G) + \mu(G)$ .*

Generalizing the reconfiguration result to multigraphs would hence be a natural question. There is however little hope to adapt the argument of our proof to this setting. In an edge-coloring of a multigraph, not only cycles can be “entangled with themselves”, but comets can also be. Thus in a multigraph, even comets can be such that each vertex of the comet is missing a different color, and our argument to handle the case of the comets for simple graphs completely collapses.

Furthermore, studying Kempe equivalence of edge-colorings in the context of list-coloring may also be an interesting question. Recently, Cranston and Mahmoud [CM21] generalized to vertex-list-coloring the result from Bonamy et al. [BBFJ19] on the Kempe-equivalence of the  $\Delta(G)$ -vertex-colorings of a regular graph  $G$ . They literally prove that the argument for vertex-coloring can be generalized to list-coloring. In the context of edge-coloring, adapting the proof to list-coloring seems much harder. Indeed, there is a substantial gap in the numbers of colors used. If we consider edge-coloring as vertex-coloring of the line graph, we use roughly  $\frac{\Delta}{2}$  colors where  $\Delta$  is the maximum degree of the line graph; in the case of vertex-coloring  $\Delta$  colors are used. Therefore, any argument based on the degeneracy of the graph (and in particular the result of Meyniel and Las Vergnas) does not seem to be of any help in this case. Nevertheless, studying Kempe swaps in the context of list-edge-coloring may be an interesting approach toward the still widely opened list-edge-coloring conjecture (see [JT95] for further details on this conjecture).

**Conjecture.** *For any graph  $G$ ,  $ch'(G) = \chi'(G)$ .*

# Bibliography

- [AC16] Armen S. Asratian and Carl Johan Casselgren. Solution of Vizing’s problem on interchanges for the case of graphs with maximum degree 4 and related results. *Journal of Graph Theory*, 82(4):350–373, 2016.
- [AH76] Kenneth Appel and Wolfgang Haken. Every planar map is four colorable. *Bulletin of the American mathematical Society*, 82(5):711–712, 1976.
- [Asr09] Armen S. Asratian. A note on transformations of edge colorings of bipartite graphs. *Journal of Combinatorial Theory, Series B*, 99(5):814–818, 2009.
- [BB18] Marthe Bonamy and Nicolas Bousquet. Recoloring graphs via tree decompositions. *European Journal of Combinatorics*, 69:200–213, 2018.
- [BBD<sup>+</sup>21] Laurent Beaudou, Caroline Brosse, Oscar Defrain, Florent Foucaud, Aurélie Lagoutte, Vincent Limouzy, and Lucas Pastor. Connected greedy colourings of perfect graphs and other classes: the good, the bad and the ugly. *arXiv preprint arXiv:2110.14003*, 2021.
- [BBFJ19] Marthe Bonamy, Nicolas Bousquet, Carl Feghali, and Matthew Johnson. On a conjecture of Mohar concerning Kempe equivalence of regular graphs. *Journal of Combinatorial Theory, Series B*, 135:179–199, 2019.
- [BC09] Paul Bonsma and Luis Cereceda. Finding paths between graph colourings: PSPACE-completeness and superpolynomial distances. *Theoretical Computer Science*, 410(50):5215–5226, 2009.
- [BCD<sup>+</sup>14] Fabrício Benevides, Victor Campos, Mitre Dourado, Simon Griffiths, Robert Morris, Leonardo Sampaio, and Ana Silva. Connected greedy colourings. In Alberto Pardo and Alfredo Viola, editors,

- 
- LATIN 2014: Theoretical Informatics*, pages 433–441, Berlin, Heidelberg, 2014. Springer.
- [BDK<sup>+</sup>21] Marthe Bonamy, Oscar Defrain, Tereza Klimošová, Aurélie Lagoutte, and Jonathan Narboni. On Vizing’s edge colouring question. *arXiv preprint arXiv:2107.07900*, 2021.
- [BDLD21] Marthe Bonamy, Vincent Delecroix, and Clément Legrand-Duchesne. Kempe changes in degenerate graphs. *arXiv preprint arXiv:2112.02313*, 2021.
- [Bei70] Lowell W. Beineke. Characterizations of derived graphs. *Journal of Combinatorial Theory*, 9(2):129–135, 1970.
- [BFKS18] Édouard Bonnet, Florent Foucaud, Eun Jung Kim, and Florian Sikora. Complexity of Grundy coloring and its variants. *Discrete Applied Mathematics*, 243:99–114, 2018.
- [BGM<sup>+</sup>21] Marthe Bonamy, Carla Groenland, Carole Muller, Jonathan Narboni, Jakub Pekárek, and Alexandra Wesolek. A note on connected greedy edge colouring. *Discrete Applied Mathematics*, 304:129–136, 2021.
- [BHLDN21] Marthe Bonamy, Marc Heinrich, Clément Legrand-Duchesne, and Jonathan Narboni. On a recolouring version of hadwiger’s conjecture. *arXiv preprint arXiv:2103.10684*, 2021.
- [BJL<sup>+</sup>14] Marthe Bonamy, Matthew Johnson, Ioannis Lignos, Viresh Patel, and Daniël Paulusma. Reconfiguration graphs for vertex colourings of chordal and chordal bipartite graphs. *Journal of Combinatorial Optimization*, 27(1):132–143, 2014.
- [BK21] Sebastien Bonduelle and František Kardoš. Subcubic planar graphs of girth 7 are class I. *arXiv preprint arXiv:2108.06115*, 2021.
- [BMNR14] Paul Bonsma, Amer E Mouawad, Naomi Nishimura, and Venkatesh Raman. The complexity of bounded length graph recoloring and CSP reconfiguration. In *International Symposium on Parameterized and Exact Computation*, pages 110–121. Springer, 2014.
- [Bri20] Gunnar Brinkmann. A simple and elementary proof of Whitney’s unique embedding theorem. *arXiv preprint arXiv:2005.04895*, 2020.
- [Bro41] Rowland Leonard Brooks. On coloring the nodes of a graph. In *Proc. Camb. Philos. Soc*, volume 37, pages 194–197, 1941.

- [CCJ<sup>+</sup>19] Yan Cao, Guantao Chen, Guangming Jing, Michael Stiebitz, and Bjarne Toft. Graph edge coloring: a survey. *Graphs and Combinatorics*, 35(1):33–66, 2019.
- [CM21] Daniel W. Cranston and Reem Mahmoud. Kempe equivalent list colorings. *arXiv preprint arXiv:2112.07439*, 2021.
- [CR15] Daniel W. Cranston and Landon Rabern. Brooks’ theorem and beyond. *Journal of Graph Theory*, 80(3):199–225, 2015.
- [CW17] Daniel W Cranston and Douglas B West. An introduction to the discharging method via graph coloring. *Discrete Mathematics*, 340(4):766–793, 2017.
- [DLV83] W. Fernandez De La Vega. On the maximum density of graphs which have no subcontraction to  $K^s$ . *Discrete Mathematics*, 46:109–110, 1983.
- [DP21] Michelle Delcourt and Luke Postle. Reducing linear Hadwiger’s conjecture to coloring small graphs. *arXiv preprint arXiv:2108.01633*, 2021.
- [Fis77] Steve Fisk. Geometric coloring theory. *Advances in Mathematics*, 24(3):298–340, 1977.
- [GK] Antonio Gallastegui and František Kardoš. Personal communication.
- [H<sup>+</sup>53] Frank Harary et al. On the notion of balance of a signed graph. *The Michigan Mathematical Journal*, 2(2):143–146, 1953.
- [Had43] Hugo Hadwiger. Über eine Klassifikation der Streckenkomplexe. *Vierteljschr. Naturforsch. Ges. Zürich*, 88(2):133–142, 1943.
- [Hea90] Percy John Heawood. Map color theorems. *Quant. J. Math.*, 24:332–338, 1890.
- [HM88] Derek A. Holton and Brendan D. McKay. The smallest non-hamiltonian 3-connected cubic planar graphs have 38 vertices. *Journal of Combinatorial Theory, Series B*, 45(3):305–319, 1988.
- [Hol81] Ian Holyer. The NP-completeness of edge-coloring. *SIAM Journal on computing*, 10(4):718–720, 1981.

- 
- [JT95] Tommy R Jensen and Bjarne Toft. 12.20 list-edge-chromatic numbers, graph coloring problems, 1995.
- [Kem79] Alfred B. Kempe. On the geographical problem of the four colours. *American journal of Mathematics*, 2(3):193–200, 1879.
- [KN21] František Kardoš and Jonathan Narboni. On the 4-color theorem for signed graphs. *European Journal of Combinatorics*, 91:103215, 2021.
- [Koc99] John A. Koch. The four-color theorem. By Rudolf Fritsch and Gerda Fritsch, translated from the German by J. Peschke. *The American Mathematical Monthly*, 106(8):785–787, 1999.
- [Kor97] Diamantis P. Koreas. The NP-completeness of chromatic index in triangle free graphs with maximum vertex of degree 3. *Applied mathematics and computation*, 83(1):13–17, 1997.
- [Kos82] Alexandr V. Kostochka. The minimum Hadwiger number for graphs with a given mean degree of vertices. *Metody Diskret. Analiz.*, (38):37–58, 1982.
- [Kos84] Alexandr V. Kostochka. Lower bound of the Hadwiger number of graphs by their average degree. *Combinatorica*, 4(4):307–316, 1984.
- [KR02] André Kündgen and Radhika Ramamurthi. Coloring face-hypergraphs of graphs on surfaces. *Journal of Combinatorial Theory, Series B*, 85(2):307–337, 2002.
- [KRF74] H. Kronk, M. Radlowski, and B. Franen. On the line chromatic number of triangle-free graphs. In *Abstract in Graph Theory Newsletter*, volume 3, 1974.
- [Kri21] Matthias Kriesell. A note on uniquely 10-colorable graphs. *Journal of Graph Theory*, 98(1):24–26, 2021.
- [LG83] D. Leven and Z. Galil. NP-completeness of finding the chromatic index of regular graphs. *Journal of Algorithms*, 4:35–44, 1983.
- [LT18] Ngoc Khang Le and Nicolas Trotignon. Connected greedy colouring in claw-free graphs. *arXiv preprint arXiv:1805.01953*, 2018.
- [LVM81] Michel Las Vergnas and Henri Meyniel. Kempe classes and the Hadwiger conjecture. *Journal of Combinatorial Theory, Series B*, 31(1):95–104, 1981.

- [Mey78] Henry Meyniel. Les 5-colorations d'un graphe planaire forment une classe de commutation unique. *Journal of Combinatorial Theory, Series B*, 24(3):251–257, 1978.
- [MG92] Jayadev Misra and David Gries. A constructive proof of Vizing's theorem. In *Information Processing Letters*. Citeseer, 1992.
- [MMS12] Jessica McDonald, Bojan Mohar, and Diego Scheide. Kempe equivalence of edge-colorings in subcubic and subquartic graphs. *Journal of Graph theory*, 70(2):226–239, 2012.
- [Moh06] Bojan Mohar. Kempe equivalence of colorings. In *Graph Theory in Paris*, pages 287–297. Springer, 2006.
- [MRŠ16] Edita Máčajová, André Raspaud, and Martin Škoviera. The chromatic number of a signed graph. *The Electronic Journal of Combinatorics*, 23(1):P1–14, 2016.
- [MRS20] Esdras Mota, Leonardo Rocha, and Ana Silva. Connected greedy coloring of  $H$ -free graphs. *Discrete Applied Mathematics*, 284:572–584, 2020.
- [MS09] Bojan Mohar and Jesús Salas. A new Kempe invariant and the (non)-ergodicity of the Wang–Swendsen–Kotecký algorithm. *Journal of Physics A: Mathematical and Theoretical*, 42(22):225204, 2009.
- [MS10] Bojan Mohar and Jesús Salas. On the non-ergodicity of the Swendsen–Wang–Kotecký algorithm on the kagomé lattice. *Journal of Statistical Mechanics: Theory and Experiment*, 2010(05):P05016, 2010.
- [MV69] LS. Melnikov and VG. Vizing. New proof of Brooks' theorem. *Journal of Combinatorial Theory*, 7(4):289–290, 1969.
- [RS83] Neil Robertson and Paul D. Seymour. Graph minors. I. Excluding a forest. *Journal of Combinatorial Theory, Series B*, 35(1):39–61, 1983.
- [RS84] Neil Robertson and Paul D. Seymour. Graph minors. III. Planar tree-width. *Journal of Combinatorial Theory, Series B*, 36(1):49–64, 1984.
- [RS86a] Neil Robertson and Paul D. Seymour. Graph minors. II. Algorithmic aspects of tree-width. *Journal of algorithms*, 7(3):309–322, 1986.

- 
- [RS86b] Neil Robertson and Paul D. Seymour. Graph minors. V. Excluding a planar graph. *Journal of Combinatorial Theory, Series B*, 41(1):92–114, 1986.
- [RS86c] Neil Robertson and Paul D. Seymour. Graph minors. VI. Disjoint paths across a disc. *Journal of Combinatorial Theory, Series B*, 41(1):115–138, 1986.
- [RS88] Neil Robertson and Paul D. Seymour. Graph minors. VII. Disjoint paths on a surface. *Journal of Combinatorial Theory, Series B*, 45(2):212–254, 1988.
- [RS90a] Neil Robertson and Paul D. Seymour. Graph minors. IV. Tree-width and well-quasi-ordering. *Journal of Combinatorial Theory, Series B*, 48(2):227–254, 1990.
- [RS90b] Neil Robertson and Paul D. Seymour. Graph minors. IX. Disjoint crossed paths. *Journal of Combinatorial Theory, Series B*, 49(1):40–77, 1990.
- [RS90c] Neil Robertson and Paul D. Seymour. Graph minors. VIII. A Kuratowski theorem for general surfaces. *Journal of Combinatorial Theory, Series B*, 48(2):255–288, 1990.
- [RS91] Neil Robertson and Paul D. Seymour. Graph minors. X. Obstructions to tree-decomposition. *Journal of Combinatorial Theory, Series B*, 52(2):153–190, 1991.
- [RS94] Neil Robertson and Paul D. Seymour. Graph minors. XI. Circuits on a surface. *Journal of Combinatorial Theory, Series B*, 60(1):72–106, 1994.
- [RS95a] Neil Robertson and Paul D. Seymour. Graph minors. XII. Distance on a surface. *Journal of Combinatorial Theory, Series B*, 64(2):240–272, 1995.
- [RS95b] Neil Robertson and Paul D. Seymour. Graph minors. XIII. The disjoint paths problem. *Journal of combinatorial theory, Series B*, 63(1):65–110, 1995.
- [RS95c] Neil Robertson and Paul D. Seymour. Graph minors. XIV. Extending an embedding. *Journal of Combinatorial Theory, Series B*, 65(1):23–50, 1995.



- [RS96] Neil Robertson and Paul D. Seymour. Graph minors: XV. Giant steps. *Journal of combinatorial theory, Series B*, 68(1):112–148, 1996.
- [RS99] Neil Robertson and Paul D. Seymour. Graph minors: XVII. Taming a vortex. *Journal of Combinatorial Theory, Series B*, 77(1):162–210, 1999.
- [RS03a] Neil Robertson and Paul D. Seymour. Graph minors. XVI. Excluding a non-planar graph. *Journal of Combinatorial Theory, Series B*, 89(1):43–76, 2003.
- [RS03b] Neil Robertson and Paul D. Seymour. Graph minors. XVIII. Tree-decompositions and well-quasi-ordering. *Journal of Combinatorial Theory, Series B*, 89(1):77–108, 2003.
- [RS04a] Neil Robertson and Paul D. Seymour. Graph minors. XIX. Well-quasi-ordering on a surface. *Journal of Combinatorial Theory, Series B*, 90(2):325–385, 2004.
- [RS04b] Neil Robertson and Paul D. Seymour. Graph minors. XX. Wagner’s conjecture. *Journal of Combinatorial Theory, Series B*, 92(2):325–357, 2004.
- [RS09] Neil Robertson and Paul D. Seymour. Graph minors. XXI. Graphs with unique linkages. *Journal of Combinatorial Theory, Series B*, 99(3):583–616, 2009.
- [RS10] Neil Robertson and Paul D. Seymour. Graph minors XXIII. Nash-Williams’ immersion conjecture. *J. Comb. Theory, Ser. B*, 100(2):181–205, 2010.
- [RS12] Neil Robertson and Paul D. Seymour. Graph minors. XXII. Irrelevant vertices in linkage problems. *Journal of Combinatorial Theory, Series B*, 102(2):530–563, 2012.
- [RSST97] Neil Robertson, Daniel Sanders, Paul D. Seymour, and Robin Thomas. The four-colour theorem. *Journal of Combinatorial Theory, Series B*, 70(1):2–44, 1997.
- [RST93] Neil Robertson, Paul D. Seymour, and Robin Thomas. Hadwiger’s conjecture for 6-free graphs. *Combinatorica*, 13(3):279–361, 1993.
- [Sok00] Alan D. Sokal. A personal list of unsolved problems concerning lattice gases and antiferromagnetic Potts models. *arXiv preprint cond-mat/0004231*, 2000.

- 
- [SZ01] Daniel P. Sanders and Yue Zhao. Planar graphs of maximum degree seven are class I. *Journal of Combinatorial Theory, Series B*, 83(2):201–212, 2001.
- [Tai80] Peter Guthrie Tait. Remarks on the colouring of maps. In *Proc. Roy. Soc. Edinburgh*, volume 10, pages 501–503, 1880.
- [Tho84] Andrew Thomason. An extremal function for contractions of graphs. In *Mathematical Proceedings of the Cambridge Philosophical Society*, volume 95, pages 261–265. Cambridge University Press, 1984.
- [Tho94] Carsten Thomassen. Every planar graph is 5-choosable. *Journal of Combinatorial Theory Series B*, 62(1):180–181, 1994.
- [Vig00] Eric Vigoda. Improved bounds for sampling colorings. *Journal of Mathematical Physics*, 41(3):1555–1569, 2000.
- [Viz64] VG. Vizing. On an estimate of the chromatic class of a p-graph. *Discret Analiz*, 3:25–30, 1964.
- [Viz65a] VG. Vizing. The chromatic class of a multigraph. *Cybernetics*, 1(3):32–41, 1965.
- [Viz65b] VG. Vizing. Critical graphs with given chromatic class. *Metody Discret. Analiz.*, 5:9–17, 1965.
- [Viz68] VG. Vizing. Some unsolved problems in graph theory. *Russian Mathematical Surveys*, 23(6):125, 1968.
- [Wag37] Klaus Wagner. Über eine Eigenschaft der ebenen Komplexe. *Mathematische Annalen*, 114(1):570–590, 1937.
- [Whi33] Hassler Whitney. 2-isomorphic graphs. *American Journal of Mathematics*, 55:245–254, 1933.
- [WSK89] Jian-Sheng Wang, Robert H. Swendsen, and Roman Kotecký. Antiferromagnetic Potts models. *Physical review letters*, 63(2):109, 1989.
- [WSK90] Jian-Sheng Wang, Robert H. Swendsen, and Roman Kotecký. Three-state antiferromagnetic potts models: A monte carlo study. *Physical Review B*, 42(4):2465, 1990.
- [Zak06] Manouchehr Zaker. Results on the Grundy chromatic number of graphs. *Discrete mathematics*, 306(23):3166–3173, 2006.

## *Bibliography*

---

- [Zas82a] Thomas Zaslavsky. Chromatic invariants of signed graphs. *Discrete Mathematics*, 42(2-3):287–312, 1982.
- [Zas82b] Thomas Zaslavsky. Signed graph coloring. *Discrete Mathematics*, 39(2):215–228, 1982.
- [Zas84] Thomas Zaslavsky. How colorful the signed graph? *Discrete Mathematics*, 52(2-3):279–284, 1984.
- [Zha00] Limin Zhang. Every planar graph with maximum degree 7 is of class 1. *Graphs and combinatorics*, 16(4):467–495, 2000.
- [Zhu20] Xuding Zhu. A refinement of choosability of graphs. *Journal of Combinatorial Theory, Series B*, 141:143–164, 2020.



# Abstract

This thesis falls within the field of graph theory, and more precisely of graph coloring with a focus on coloring reconfiguration and edge-coloring. In this thesis, we mainly study the Kempe swaps, a tool to locally transform a coloring into another coloring. This concept is one of the key ideas of the proof of the four-color theorem. We first give an overview of the history of this tool, present how it became one of the most fruitful tool regarding graph coloring questions, and introduce questions that fall within the more general field of combinatorial reconfiguration that emerged from this concept.

We then present our result on greedy edge-coloring and vertex-coloring reconfiguration of  $K_t$ -minor free graphs. Regarding edge-coloring reconfiguration, we prove in particular that all  $(\chi'(G) + 1)$ -colorings are Kempe equivalent (*i.e.* one can transform any coloring into any other coloring using only Kempe swaps), thus proving a conjecture of Vizing of 1965. We finally present our work on coloring of signed planar graphs, and on edge-coloring of triangle-free planar graphs of maximum degree 4.