

Colourings of oriented graphs

Éric SOPENA

LaBRI, Bordeaux University

France

Outline

Preliminary (basic) notions

Oriented vertex-colourings

Oriented arc-colourings

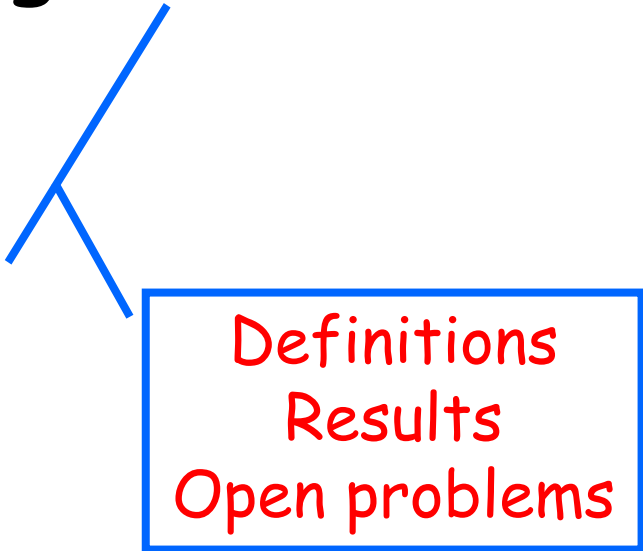

Definitions
Results
Open problems

Preliminary (basic) notions (1)

Vertex-Colourings of undirected graphs

A (proper) **k-vertex-colouring** of a graph G is a mapping $c : V(G) \rightarrow \{1, 2, \dots, k\}$ such that every two *adjacent vertices* are assigned *distinct colours*.

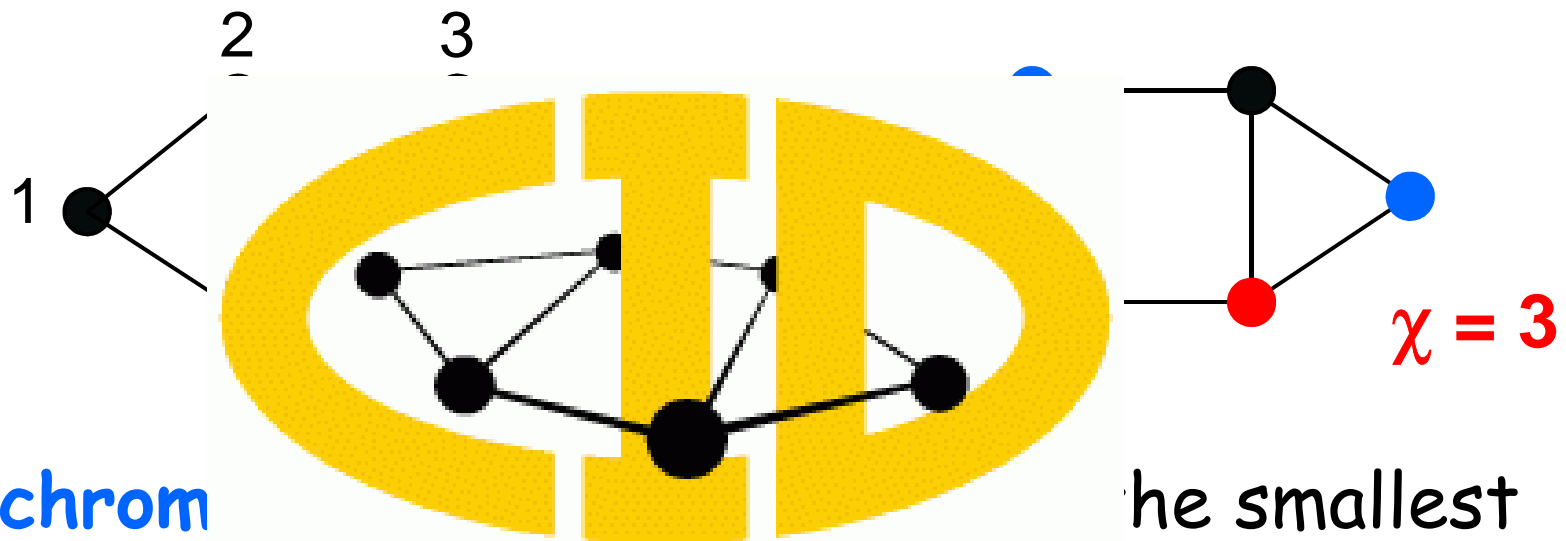

The **chrom**
k for which G has a k-vertex-colouring.

Preliminary (basic) notions (2)

Edge-Colourings of undirected graphs

A (proper) **k-edge-colouring** of a graph G is a mapping $c : E(G) \rightarrow \{1, 2, \dots, k\}$ such that every two *incident edges* are assigned *distinct colours*.

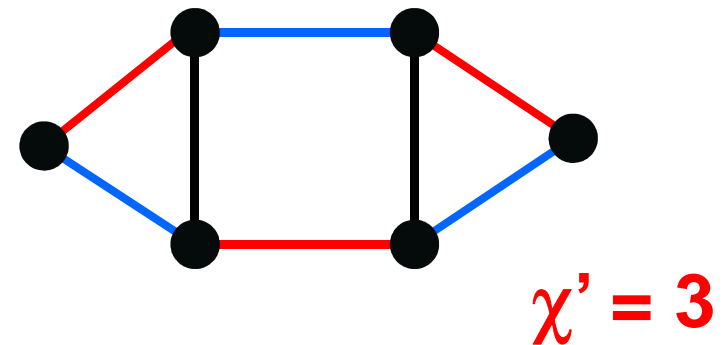
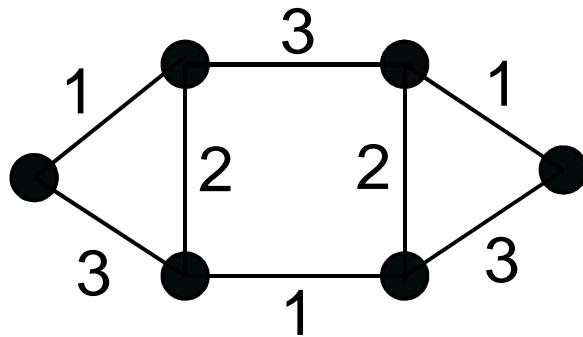

The **chromatic index** $\chi'(G)$ of G is the smallest k for which G has a k -edge-colouring.

Preliminary (basic) notions (3)

Line-graphs

The **line-graph** $L(G)$ of G is given by :

- $V(L(G)) = E(G)$,
- $(e,f) \in E(L(G))$ iff e and f are *incident* in G .

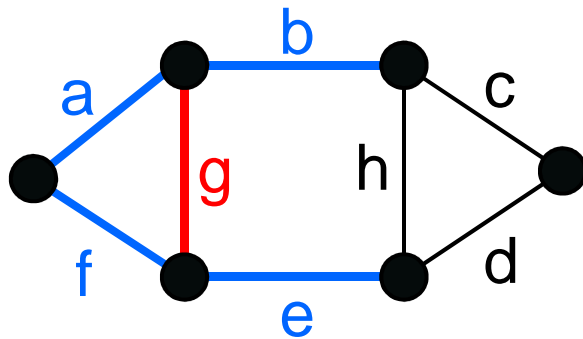

The graph G

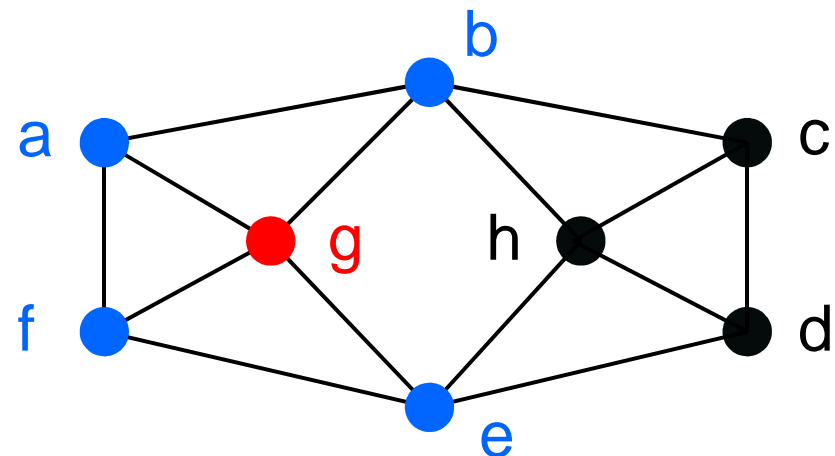

The line-graph $L(G)$ of G

Preliminary (basic) notions (4)

Vertex-colourings vs edge-colourings

An edge-colouring of G is nothing but a vertex-colouring of $L(G)$.

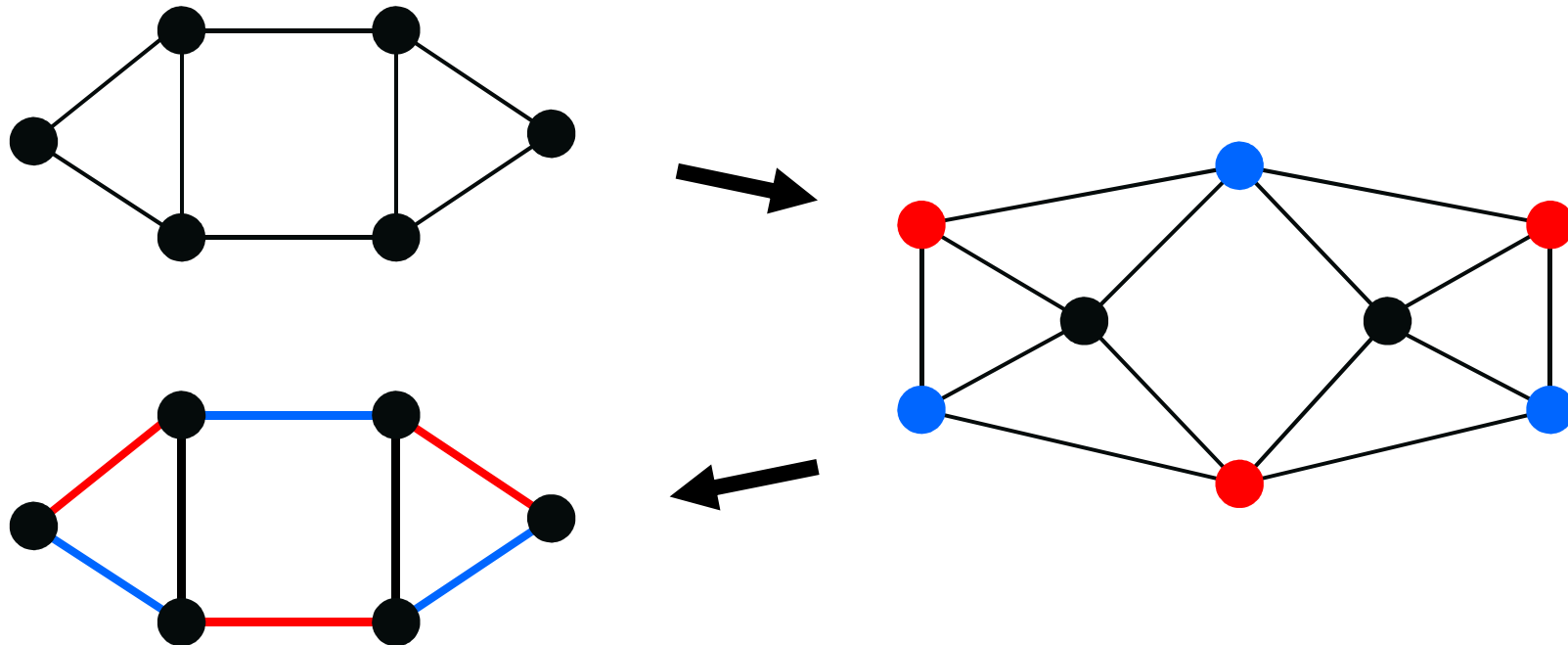

Preliminary (basic) notions (5)

Homomorphisms of undirected graphs

A **homomorphism** from G to H is a mapping $h : V(G) \rightarrow V(H)$ such that :

$$xy \in E(G) \Rightarrow h(x)h(y) \in E(H)$$

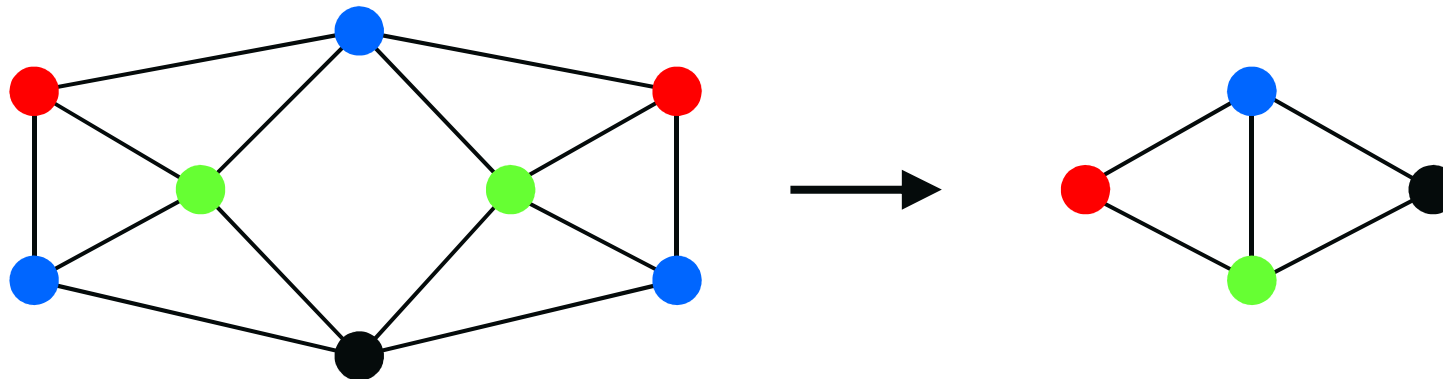

Notation.

$G \rightarrow H$: there exists a homomorphism from G to H

Preliminary (basic) notions (6)

Vertex-colourings vs homomorphisms

A k -vertex-colouring of G is nothing but a *homomorphism* from G to K_k , the *complete graph* on k vertices.

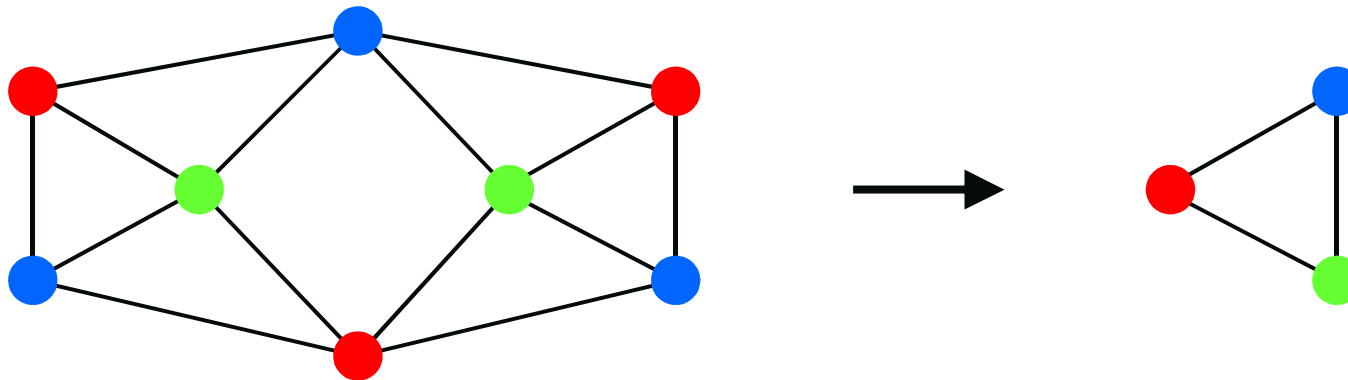

Remark.

$\chi(G) = k$ if and only if $G \rightarrow K_k$ and $G \not\rightarrow K_{k-1}$

Preliminary (basic) notions (7)

Oriented graphs

An **oriented graph** is an *antisymmetric* digraph (no directed cycle of length 1 or 2).

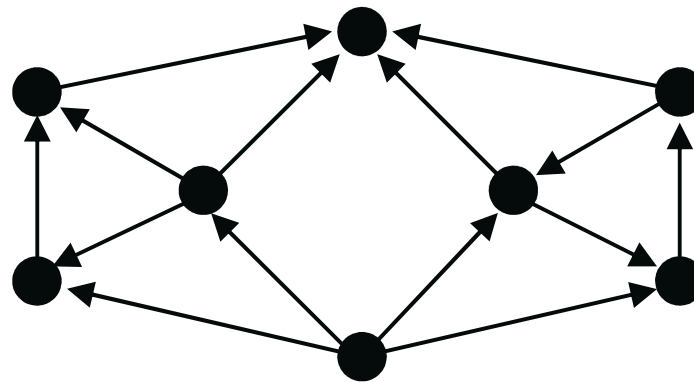

An oriented graph is an *orientation* of some undirected graph, obtained by giving to each edge one of its two possible orientations.

Preliminary (basic) notions (8)

Homomorphisms of oriented graphs

A **homomorphism** from G to H is a mapping $h : V(G) \rightarrow V(H)$ such that :

$$xy \in E(G) \Rightarrow h(x)h(y) \in E(H)$$

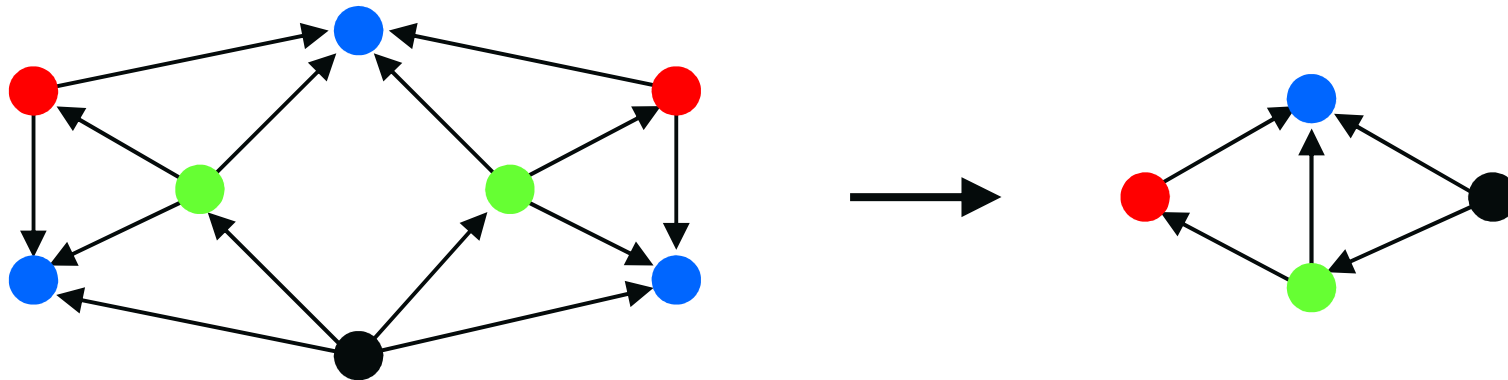

Oriented vertex colourings (1)

Oriented Vertex-Colourings of oriented graphs

An **oriented k -vertex-colouring** of an oriented graph G is a mapping $c : V(G) \rightarrow \{1, 2, \dots, k\}$ such that:

$$(1) uv \in E(G) \Rightarrow c(u) \neq c(v)$$

$$(2) uv, wx \in E(G), c(u) = c(x) \Rightarrow c(v) \neq c(w)$$

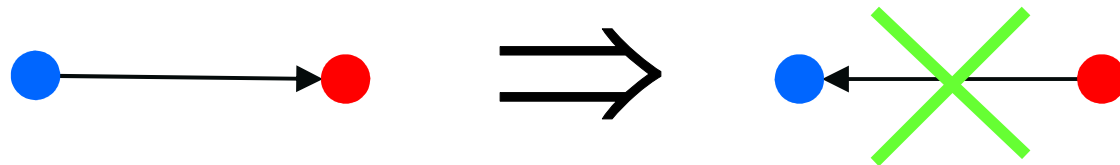

Hence, all the arcs linking two colour classes (independent sets) have the same direction.

Oriented vertex colourings (2)

Examples.

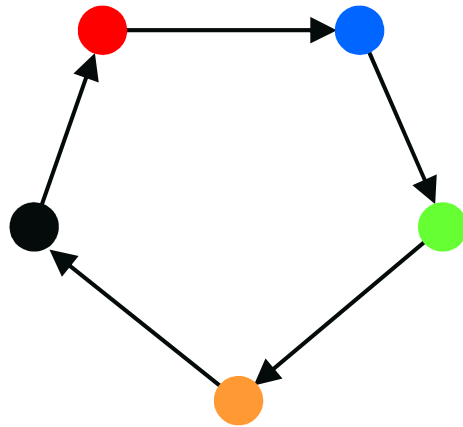

Any two vertices linked by a directed path of length 1 or 2 must get distinct colours.

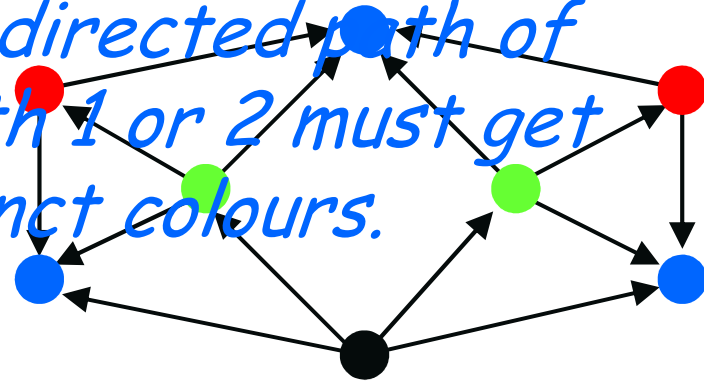

Remark.

An oriented k -colouring of an oriented graph is nothing but a *homomorphism* to a given oriented graph (or *tournament*) of order k .

Oriented chromatic number (1)

Oriented chromatic number of oriented graphs

The **oriented chromatic number** $\chi_o(G)$ of an oriented graph G is the smallest k such that G admits an oriented k -vertex-colouring.

(Or, equivalently, the minimal order of an oriented graph H such that $G \rightarrow H$)

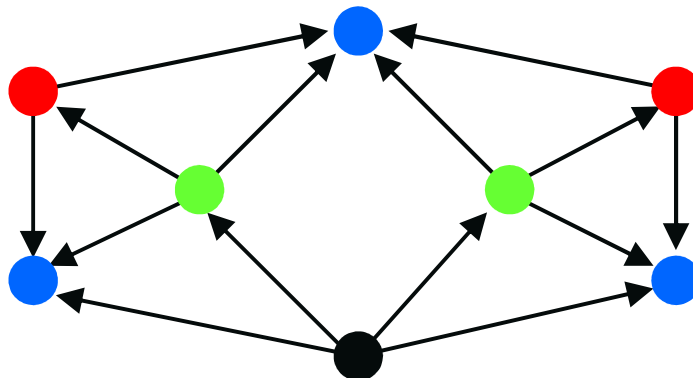

$$\chi_o = 4$$

Oriented chromatic number (2)

Oriented chromatic number of undirected graphs

The **oriented chromatic number** $\chi_o(U)$ of an *undirected* graph U is the smallest k such that *every orientation* of U admits an oriented k -vertex-colouring:

$$\chi_o(U) = \max \{ \chi_o(G) ; G \text{ orientation of } U \}$$

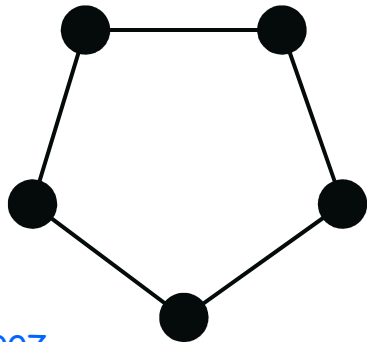

$$\chi_o = 5$$

Observation.
 $\chi(U) = \min \{ \dots \}$

Oriented chromatic number (3)

Oriented chromatic number of graph families

The **oriented chromatic number** $\chi_o(\mathbf{F})$ of a family \mathbf{F} of (undirected or oriented) graphs is given by:

$$\chi_o(\mathbf{F}) = \max \{ \chi_o(G) ; G \in \mathbf{F} \}$$

Example.

$$\chi_o(\text{trees}) = 3$$



at least 3...

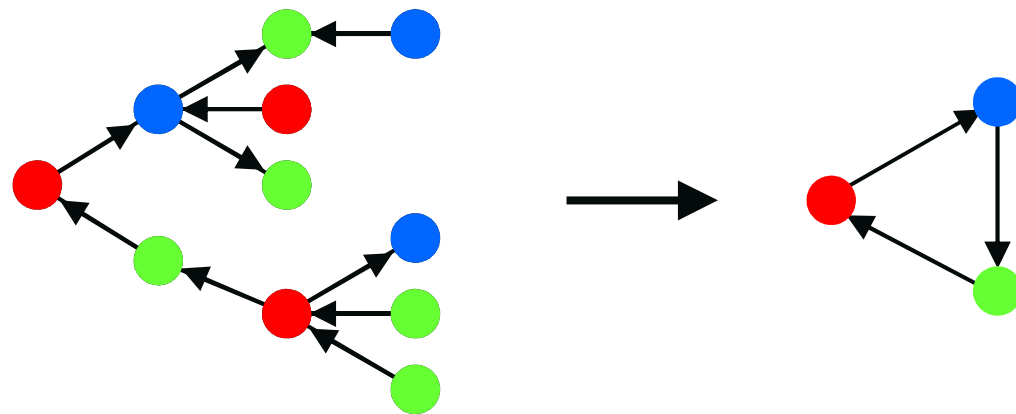

at most 3...

Universal graphs

(1)

An oriented graph U is said to be **universal** for a family \mathbf{F} of oriented (resp. undirected) graphs if every member (resp. every orientation of every member) of \mathbf{F} admits a homomorphism to U .

$$\mathbf{F} \rightarrow U \text{ means } \forall G \in \mathbf{F}, G \rightarrow U$$

Example.

The directed cycle on 3 vertices is universal for the family of trees.

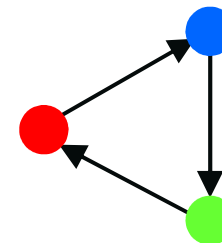

Remark.

If U is universal for \mathbf{F} then $\chi_o(\mathbf{F}) \leq |V(U)|$

Universal graphs

(2)

Outerplanar graphs

Let QR_7 be the tournament given by:

- $V(QR_7) = \{0, 1, \dots, 6\}$

- $uv \in E(QR_7)$ iff $v - u \pmod{7} = 1, 2$ or 4

(non-zero quadratic residues of 7)

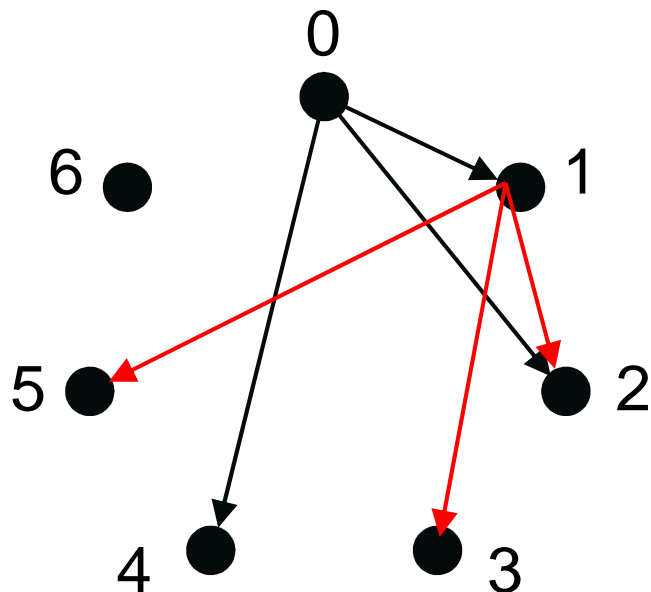

Claim.

QR_7 is universal for the family \mathcal{O} of outerplanar graphs.

Universal graphs

(3)

Proof of our claim

The graph QR_7 has the following property:

(P₂) For every arc $uv \in E(QR_7)$, there exists a vertex w for every possible orientation of the edges uw and vw :

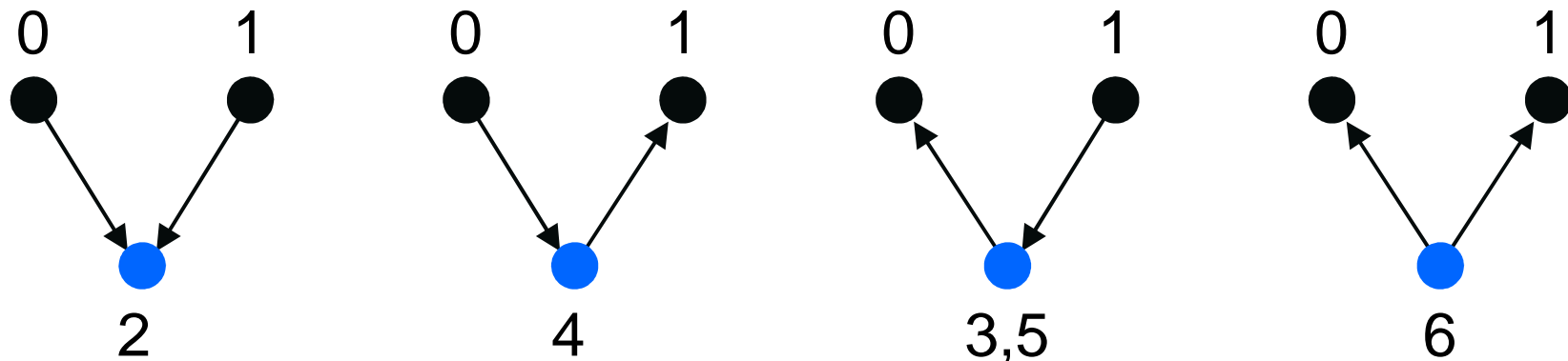

Universal graphs

(4)

Proof of our claim (cont.)

Every outerplanar graph has a vertex of degree at most 2.

Simple induction...

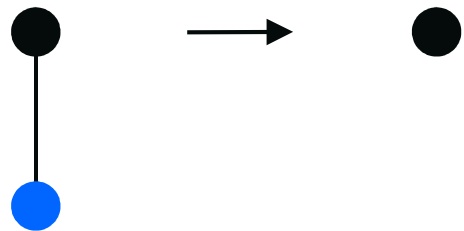

1-vertex

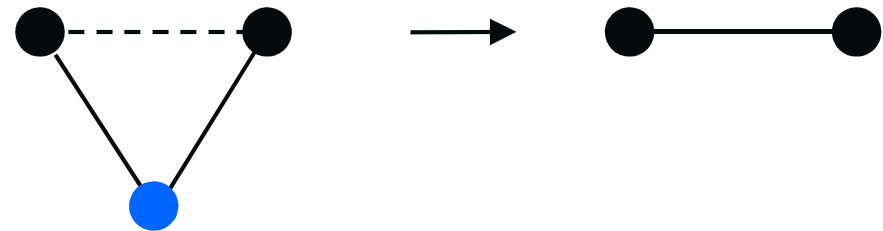

2-vertex

Corollary. $\chi_o(\mathcal{O}) \leq 7$

Oriented cliques (o-cliques) (1)

Oriented cliques

An **oriented clique** C is (a subgraph of) a graph satisfying $\chi_o(C) = |V(C)|$.

Examples.

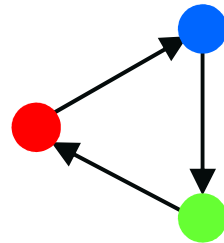

(tournaments...)

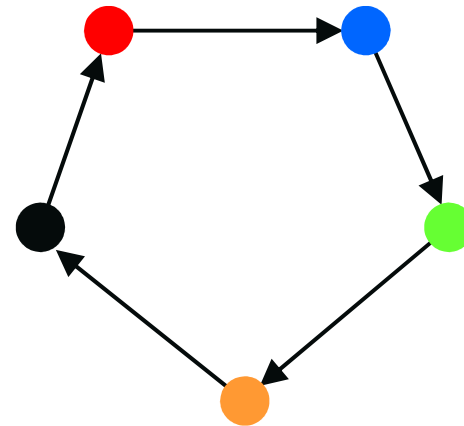

Remark. An o-clique is nothing but an oriented graph in which any two vertices are linked by a directed path (in any direction) of length ≤ 2 ...

Oriented cliques (o-cliques) (2)

Oriented o-cliques of order $2^k - 1$

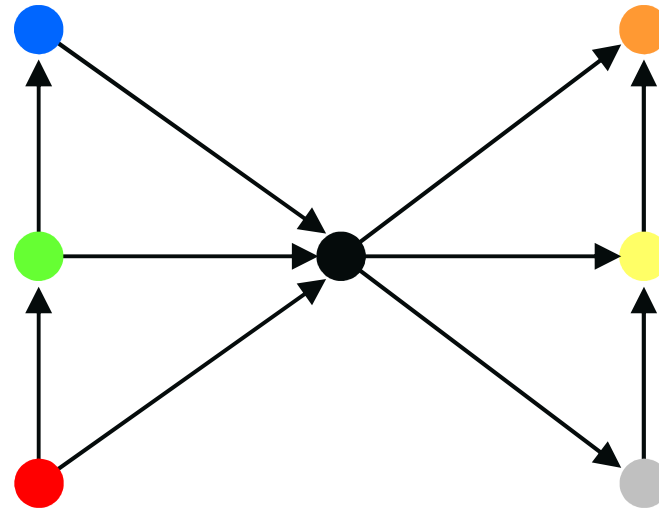
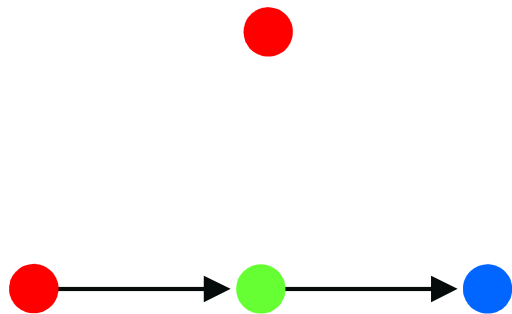

outerplanar...

Corollary. $\chi_o(\mathbf{O}) = 7$

Oriented cliques (o-cliques) (3)

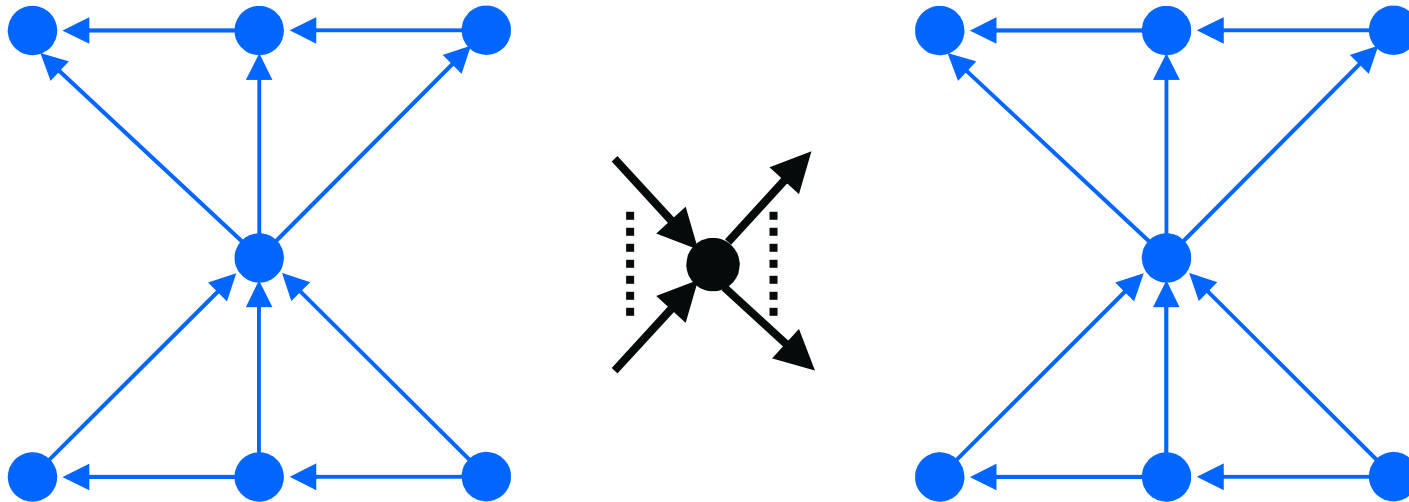

planar...

Corollary. $\chi_o(\mathcal{P}) \geq 15$

(\mathcal{P} is the family of planar graphs)

Oriented cliques (o-cliques) (4)

Question 1.

What is the maximal order (number of vertices) of a planar o-clique ?

Klostermeyer and MacGillivray (2002)

The order of a planar o-clique is at most 36.

Conjecture. No planar o-clique has more than 15 vertices.

Complete families of graphs (1)

A family of graphs \mathcal{F} is said to be **complete** if for any two graphs A, B in \mathcal{F} there exists a graph C in \mathcal{F} having both A and B as *subgraphs*.

Examples.

Outerplanar graphs, planar graphs, graphs with bounded degree, k -trees, etc.

The family of *connected cubic graphs* is not complete...

Property. Every complete family \mathcal{F} with bounded χ_0 admits a universal graph U with $|U| = \chi_0(\mathcal{F})$.

Complete families of graphs (2)

Oriented chromatic number of complete families

To find an upper bound for this oriented chromatic number, it suffices to find a *universal graph*.

Example.

The tournament QR_{11} is universal for the family of graphs *degree at most 3*.

Hence,

$$\chi_o(\mathbf{D}_3) \leq 11$$

Complete families of graphs (3)

Open Problem A.

*Determine the oriented chromatic number of the family of **connected** graphs with degree at most 3 (known to be at least 7).*

This family is not complete...

Conjecture. The answer is 7.

Best known upper bound : 11

[Vignal, S., 1996]

Planar graphs

(1)

Acyclic colourings of undirected graphs

A k -vertex-colouring of an undirected graph G is **acyclic** if every cycle in G uses *at least 3 colours*.

(in other words, any two colours induce a forest)

Theorem [Borodin, 1979].

Every planar graph admits an acyclic 5-colouring.

And this bound is tight...

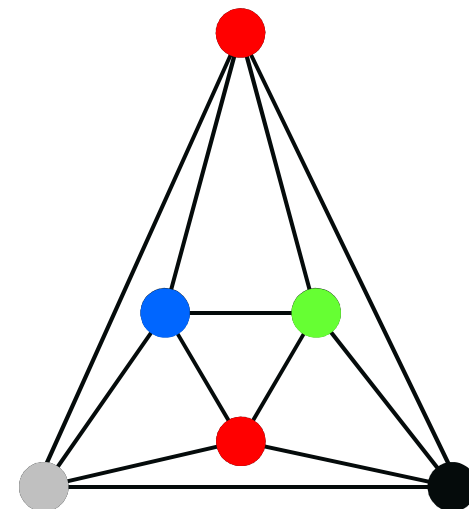

Planar graphs

(2)

Oriented colourings of planar graphs

Theorem [Raspaud, S., 1994]

If G admits an acyclic k -vertex-colouring, then

$$\chi_o(G) \leq k \cdot 2^{k-1}$$

And this bound is tight [Ochem, 2005].

Corollary.

Every oriented planar graph admits an oriented 80-colouring.

$$\chi_o(P) \leq 80$$

Planar graphs

(3)

Sketch of proof

Let G be a planar graph and c a k -acyclic colouring of G .

Let a, b be any two colours with $a < b$. Let H be any orientation of G and consider the subgraph $H_{a,b}$ induced by vertices *with colour a or b* (which is a forest).

$a < b$

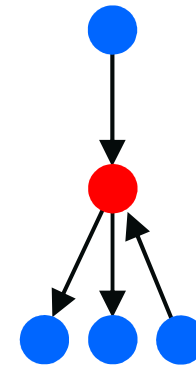
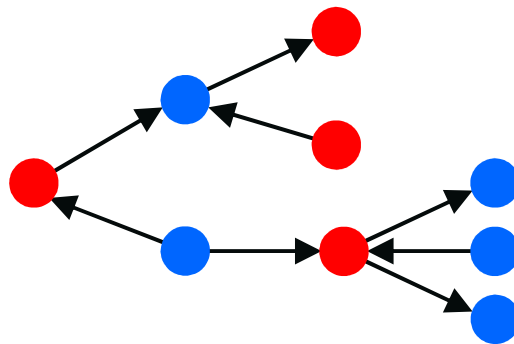

Planar graphs

(4)

Sketch of proof (cont.)

Choose a vertex in each component of $H_{a,b}$.

Associate a bit with value 0 with each of them.

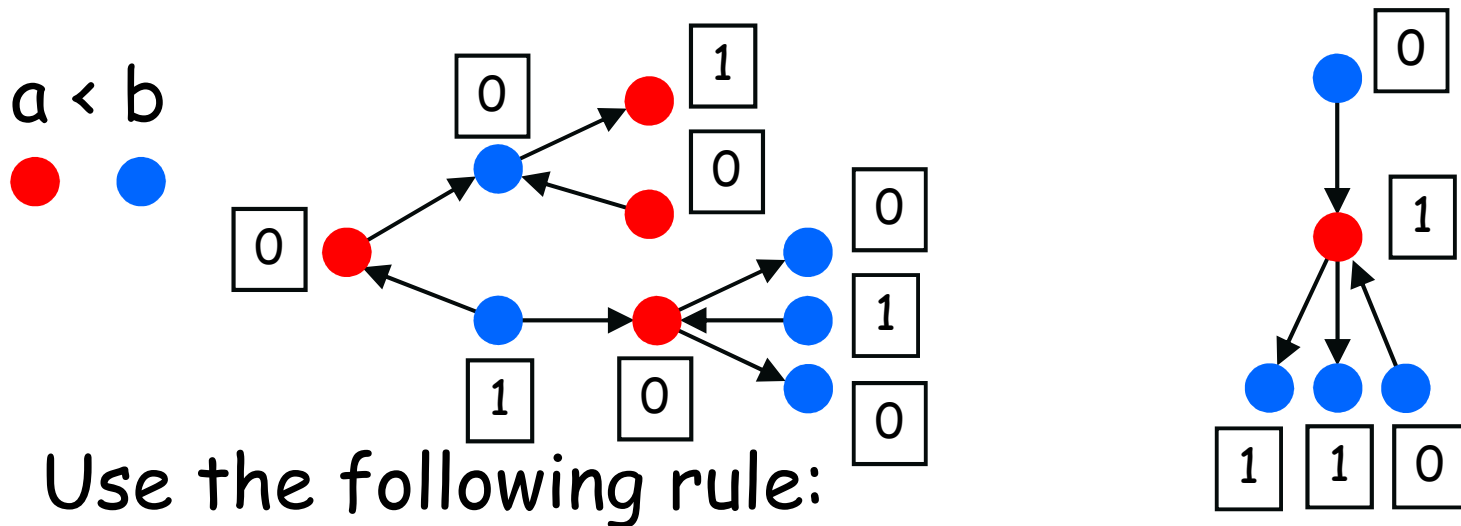

- → ● ($a < b$) : keep the same bit
- → ● ($b > a$) : change the bit

Planar graphs

(5)

Sketch of proof (cont.)

Doing that, we have constructed a homomorphism from $H_{a,b}$ to the following graph:

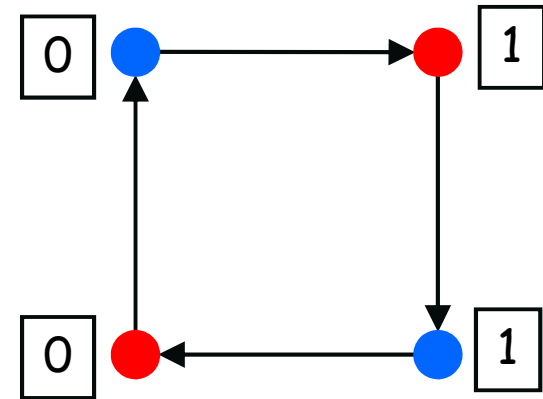

With any colour a , we associate $k-1$ such bits (one for each other colour).

We thus obtain an oriented colouring of H using at most $k \cdot 2^{k-1}$ colours.

Planar graphs

(6)

Open Problem B.

Determine the oriented chromatic number of the family of planar graphs.

Conjecture. no conjecture !...

Best known lower bound : 17

[Marshall, 2001]

Planar graphs

(7)

Simple colourings

[Smolíková, 2000]

A **simple k -vertex-colouring** of an oriented graph G is a mapping $c : V(G) \rightarrow \{1, 2, \dots, k\}$ such that:

(1) $E(G) \neq \emptyset \Rightarrow \exists u, v$ s.t. $c(u) \neq c(v)$

(2) $uv, wx \in E(G), c(u) \neq c(v), c(u) = c(x)$

$\Rightarrow c(v) \neq c(w)$

Example.

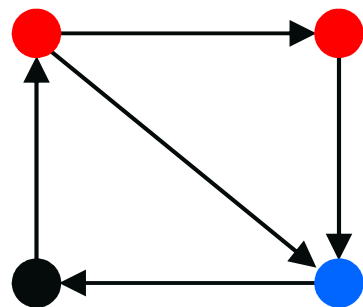

$\chi_s(G)$ = simple chromatic number of G .

Theorem. $\chi_o(P) = \chi_s(P)$

Planar graphs

(8)

Open Problem C.

Determine the oriented chromatic number of the family of triangle-free planar graphs.

Conjecture. no conjecture !...

Best known lower bound : 11 [Ochem, 2004]

Best known upper bound : 47

[Borodin, Ivanova, 2005]

Some other results on χ_0 (1)

Planar graphs with large girth

The **girth** $g(G)$ of a graph G is the size of a *shortest* cycle in G .

girth	lower bound	upper bound	
3	17	80	Marshall 2001 - Raspaud, S., 1994
4	11	47	Ochem, 2004 - Borodin, Ivanova 2005
5	6	16	Borodin, Kostochka, Nešetřil, Raspaud, S., 1999 - Pinlou, 2007
6	6	11	Borodin, Kostochka, Nešetřil, Raspaud, S., 1999
$7 \leq g \leq 10$	5	7	Nešetřil, Raspaud, S., 1997 - Borodin, Ivanova 2005
11	5	6	id. - Pinlou, S., 2006
$g \geq 12$	5	5	id. - Borodin, Ivanova, Kostochka, 2007

Some other results on χ_o (2)

Outerplanar graphs with large girth

girth	lower bound	upper bound	
3	7	7	S., 1997
4	6	6	Hosseini Dolama, 2006 - Pinlou, S., 2006
$g \geq 5$	5	5	Nešetřil, Raspaud, S., 1997 - Pinlou, S., 2006

Question 2.

What is the oriented chromatic number of the family of k -outerplanar graphs ?

$$\chi_o(2-O) \leq 67 \quad [\text{Esperet, Ochem, 2007}]$$

Some other results on χ_o (3)

Graphs with bounded degree

We have seen before :

$$7 \leq \chi_o(\mathbf{D}_3) \leq 11$$

Theorem (Kostochka, S., Zhu, 1997).

If G has maximum degree Δ , then

$$\chi_o(G) \leq 2 \cdot \Delta^2 \cdot 2^\Delta$$

For every Δ , there exists a graph with maximum degree at most Δ and oriented chromatic number at least $2^{\Delta/2}$.

Some other results on χ_0 (4)

(partial) k-trees

A **k-tree** is a graph obtained from the *complete graph* K_k , by repeatedly adding new vertices linked to a *clique of size k* (a 1-tree is a tree...).

Example (3-trees).

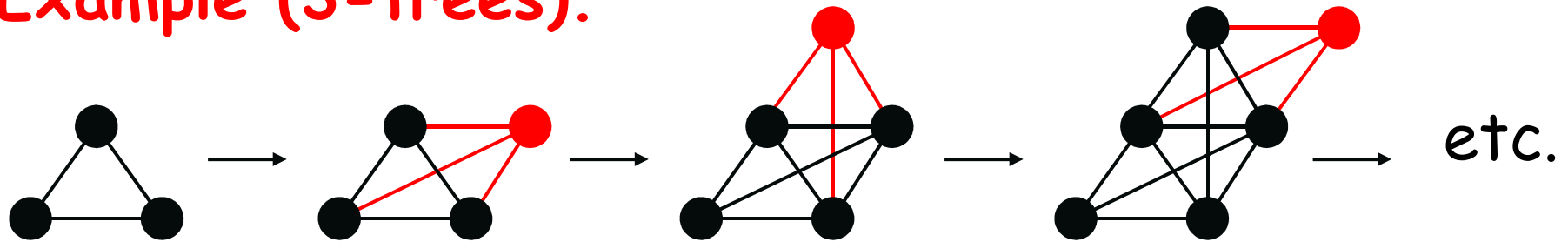

A **partial k-tree** is a *subgraph* of a k-tree.

Some other results on χ_0 (5)

(partial) k -trees (cont.)

Theorem (S., 1997).

- $\chi_0(\mathcal{T}_2) = 7$
- $\chi_0(\mathcal{T}_3) = 16$
- $2^{k+1} - 1 \leq \chi_0(\mathcal{T}_k) \leq (k + 1) \cdot 2^k$

O -cliques of order $2^{k+1} - 1$ are k -trees...

Universal graph for \mathcal{T}_3 : construction due to
J. Tromp [1990's]

Some other results on χ_0 (6)

Tromp's construction (the graph T_{16})

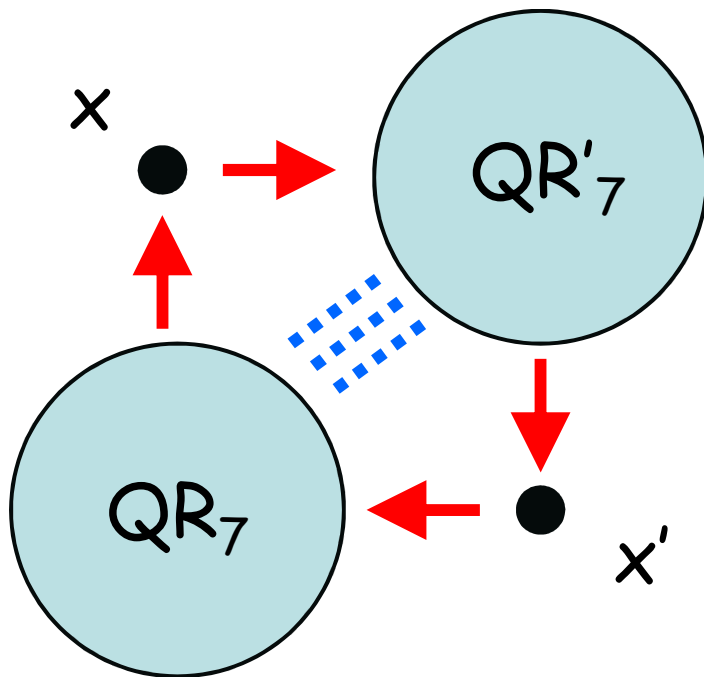

Property.

For every vertex u ,
 $\Gamma^+(u) \sim \Gamma^-(u) \sim QR_7$

This property is true for any QR_p , p prime, $p = 4k + 3$.

$$\begin{aligned} \text{..... } uv', u'v \in E(T_{16}) &\Leftrightarrow vu \in E(QR_7) \\ &u - v \equiv 1, 2 \text{ or } 4 \pmod{7} \end{aligned}$$

Some other results on χ_0 (7)

Tromp's construction (the graph T_{16})

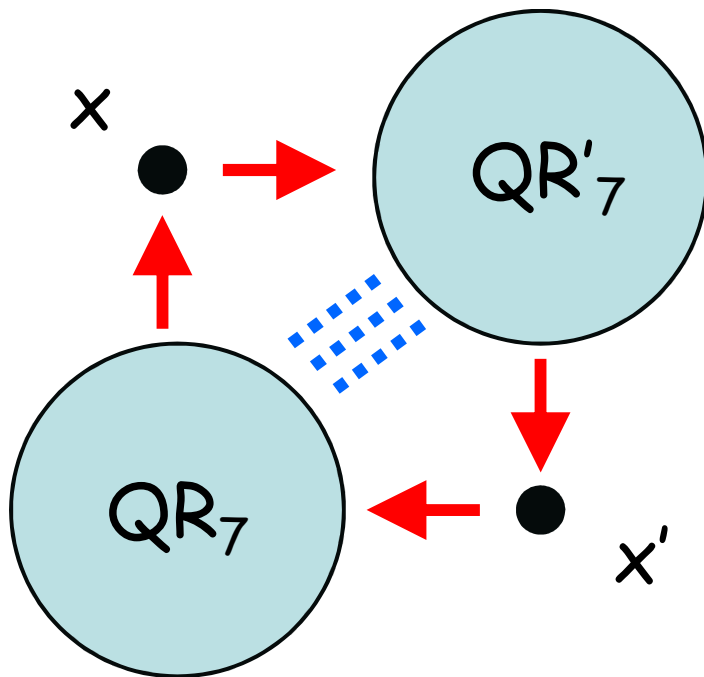

Property P_3 .

For every *triangle* u, v, w , there exists a vertex z for every possible orientation of the edges uz , vz and wz .

(no graph of order 15 satisfies this property...)



$$uv', u'v \in E(T_{16}) \Leftrightarrow vu \in E(QR_7)$$

$$u - v \equiv 1, 2 \text{ or } 4 \pmod{7}$$

Some other results on χ_o (8)

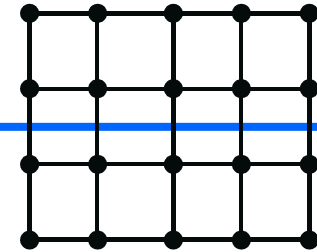

Open Problem D.

Determine the oriented chromatic number of the family of 2-dimensional grids.

Conjecture. 7 (proven ≤ 11) [Fertin, Raspaud, Roychowdhury, 2003]

QR_7 is not universal [Szepietowski, Targan, 2004]

Open Problem E.

Determine the oriented chromatic number of the family of hypercubes.

Complexity

k-O-COL problem

Instance: an oriented graph G

Question: is $\chi_o(G) \leq k$?

This problem is polynomial for $k \leq 3$, NP-complete for $k \geq 4$.

[Klostermeyer, MacGillivray, 2004]

It is still NP-complete for bipartite planar circuit-free graphs.

[Culus, Demange, 2007]

Oriented arc colourings (1)

Oriented Arc-Colourings of oriented graphs

An **oriented k -arc-colouring** of an oriented graph G is a mapping $c : E(G) \rightarrow \{1, 2, \dots, k\}$ such that:

$$(1) uv, vw \in E(G) \Rightarrow c(uv) \neq c(vw)$$

$$(2) uv, vw, xy, yz \in E(G), c(uv) = c(yz) \\ \Rightarrow c(vw) \neq c(xy)$$

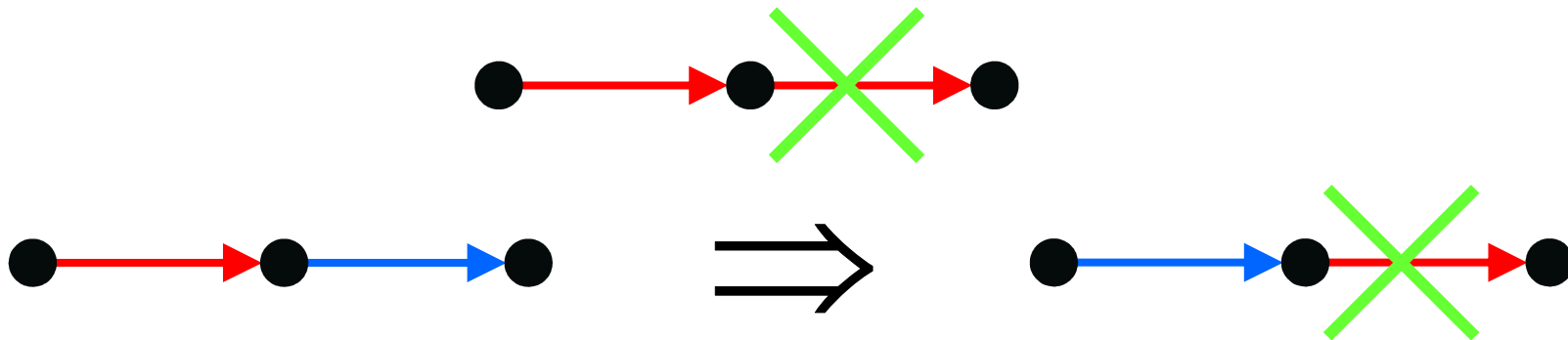

Oriented arc colourings

(2)

Examples.

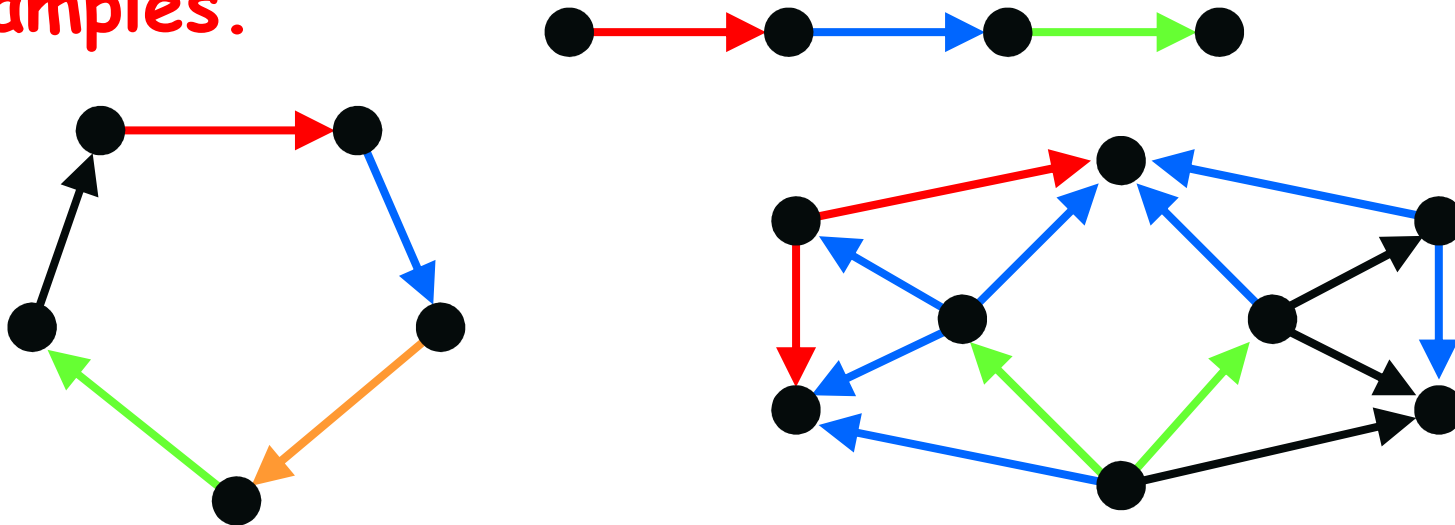

Oriented chromatic index of oriented graphs

The **oriented chromatic index** $\chi'_o(G)$ of an oriented graph G is the smallest k such that G admits an oriented k -arc-colouring.

Oriented arc colourings (3)

Line digraph

The **line-digraph** $LD(G)$ of a digraph G is given by:

- $V(LD(G)) = E(G)$,
- $(e, f) \in E(LD(G))$ iff f "*follows*" e
(that is $e = uv$ and $f = vw$)

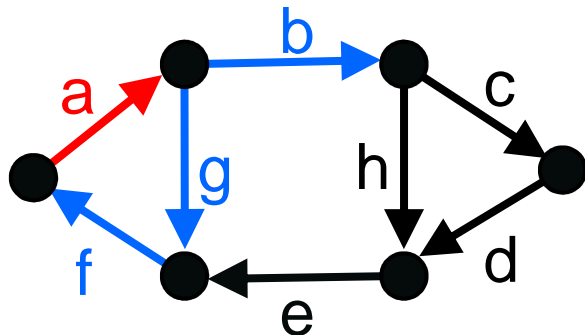

The graph G

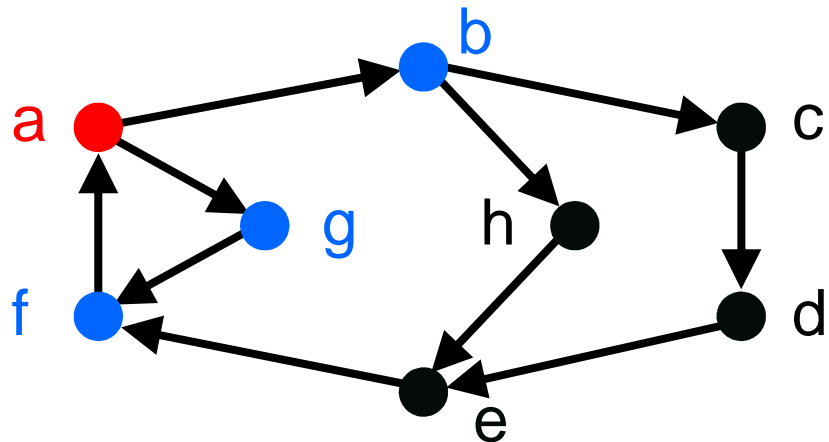

The line-digraph $LD(G)$ of G

Oriented arc colourings

(4)

An oriented arc-colouring of G is nothing but an oriented *vertex-colouring* of the *line-digraph* of G .

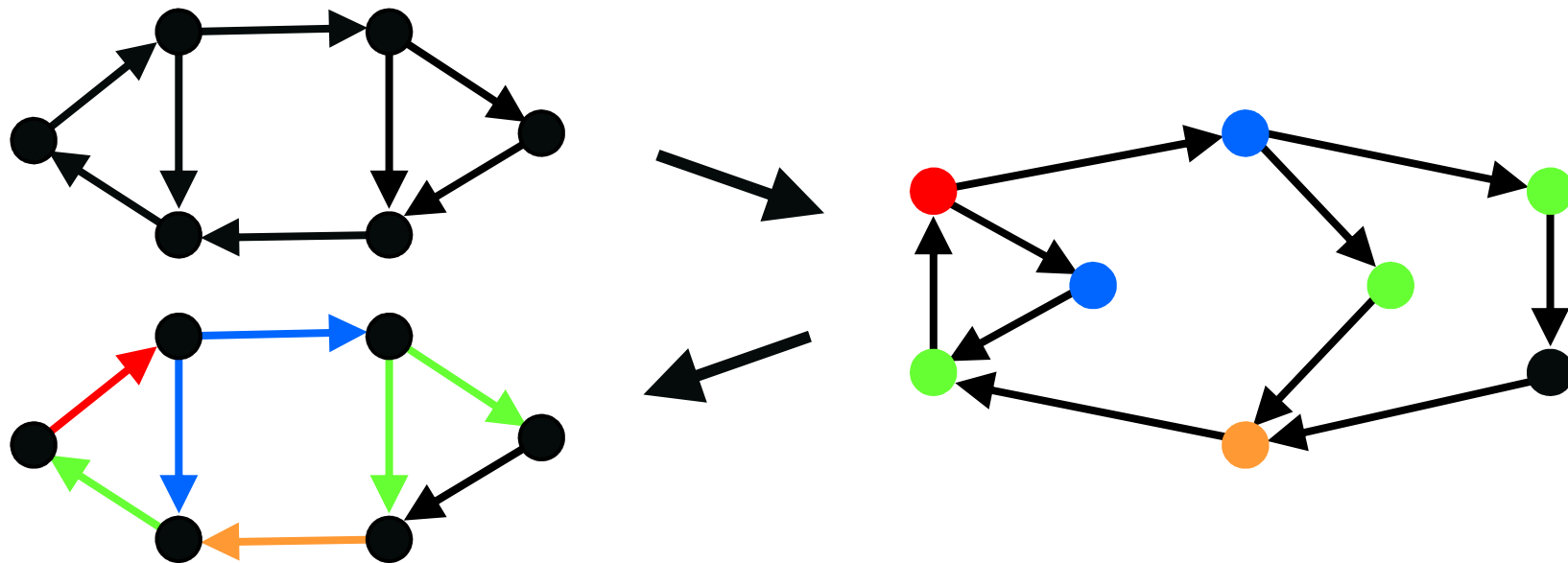

Hence, $\chi'_o(G)$ is the minimum order of an oriented graph H such that $LD(G) \rightarrow H$.

χ'_o versus χ_o

(1)

Observation.

For every graph G , $\chi'_o(G) \leq \chi_o(G)$

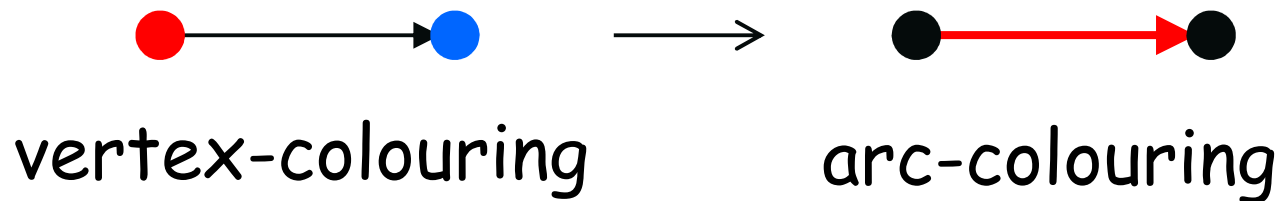

And this bound is tight:

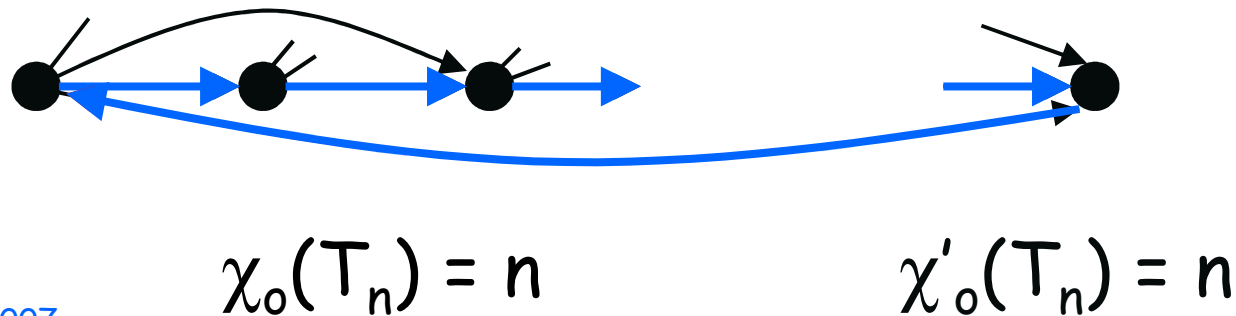

χ'_o versus χ_o

(2)

Question.

Is there a function Φ such that $\chi_o(G) \leq \Phi(\chi'_o(G))$?

The answer is yes (optimal Φ).

[Ochem, Pinlou, S., 2007]

χ'_0 versus χ_0

(3)

Let G be an oriented graph. We define the mapping μ_G as follows:

$$\begin{aligned} \mu_G : 2^{V(G)} &\rightarrow 2^{V(G)} \\ s &\rightarrow s \cup \{ \Gamma^+(u) ; u \in s \} \end{aligned}$$

Example.

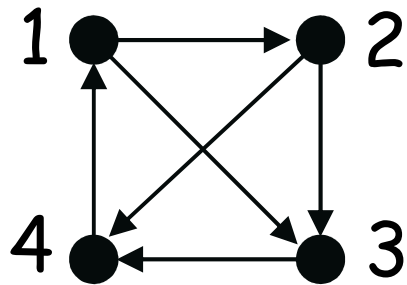

$$\begin{aligned} \emptyset &\rightarrow \emptyset \\ \{1,2\}, \{1\} &\rightarrow \{1,2,3\} \\ \{2,3\}, \{2\} &\rightarrow \{2,3,4\} \\ \{3\} &\rightarrow \{3,4\} \\ \{4\} &\rightarrow \{1,4\} \\ \{3,4\} &\rightarrow \{1,3,4\} \end{aligned}$$

$$\{1,3\}, \{1,4\}, \{2,4\}, \{1,2,3\}, \{1,2,4\}, \{1,3,4\}, \{2,3,4\}, \{1,2,3,4\} \rightarrow \{1,2,3,4\}$$

χ'_0 versus χ_0

(4)

Now, let $Q(G)$ be defined as:

$$Q(G) = \{ \mu_G(s) ; s \in 2^{V(G)} \}$$

Example.

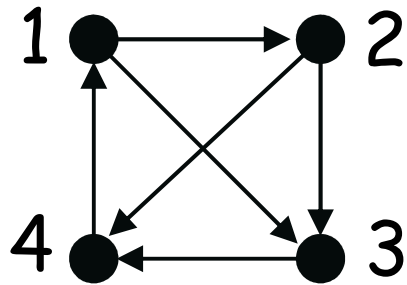

$$\begin{aligned} \emptyset &\rightarrow \emptyset \\ \{1,2\}, \{1\} &\rightarrow \{1,2,3\} \\ \{2,3\}, \{2\} &\rightarrow \{2,3,4\} \\ \{3\} &\rightarrow \{3,4\} \\ \{4\} &\rightarrow \{1,4\} \\ \{3,4\} &\rightarrow \{1,3,4\} \end{aligned}$$

$$\{1,3\}, \{1,4\}, \{2,4\}, \{1,2,3\}, \{1,2,4\}, \{1,3,4\}, \{2,3,4\}, \{1,2,3,4\} \rightarrow \{1,2,3,4\}$$

$$Q(T) = \{ \emptyset, \{1,4\}, \{3,4\}, \{1,2,3\}, \{1,3,4\}, \{2,3,4\}, \{1,2,3,4\} \}$$

χ'_0 versus χ_0

(5)

For each subset s in $Q(G)$ define:

$$s^+ = \{ u \in s ; \Gamma^+(u) \subseteq s \}$$

Example.

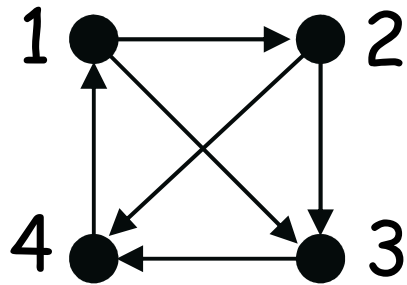

$$\{1,2,3\}^+ = \{1\}$$

$$\{2,3,4\}^+ = \{2,3\}$$

$$\emptyset^+ = \emptyset, \quad \{1,2,3,4\}^+ = \{1,2,3,4\}$$

$$Q(T) = \{ \emptyset, \{1,4\}, \{3,4\}, \{1,2,3\}, \{1,3,4\}, \{2,3,4\}, \{1,2,3,4\} \}$$

χ'_o versus χ_o

(6)

Lemma.

Let G be an oriented graph with $\chi'_o(G) = k$ and T_k be any oriented graph s.t. $LD(G) \rightarrow T_k$.

Then, $\chi_o(G) \leq |Q(T_k)|$.

Example.

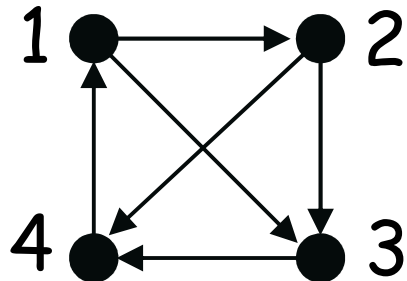

$$c : V(G) \rightarrow Q(T_k)$$

$$u \rightarrow \mu_{T_k}(c'(\Gamma^+(u)))$$

Hence, $LD(G) \rightarrow T \Rightarrow \chi_o(G) \leq 7$

$$Q(T) = \{ \emptyset, \{1,4\}, \{3,4\}, \{1,2,3\}, \{1,3,4\}, \{2,3,4\}, \{1,2,3,4\} \}$$

χ'_0 versus χ_0

(7)

Lemma.

For every tournament T_k of order k , there exists an oriented graph G with:

$$LD(G) \rightarrow T_k \quad \text{and} \quad \chi_0(G) = |Q(T_k)|$$

Example.

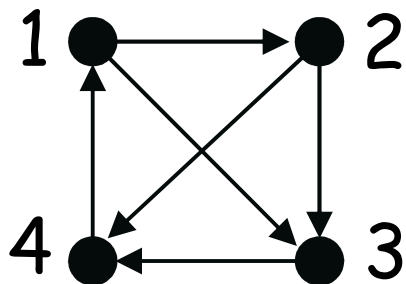

$$V(G) = Q(T_k)$$

$$s \rightarrow s' \text{ iff } \exists u, u \in s^+, u \notin s'$$

$$\{2, 3, 4\}^+ = \{2, 3\}$$

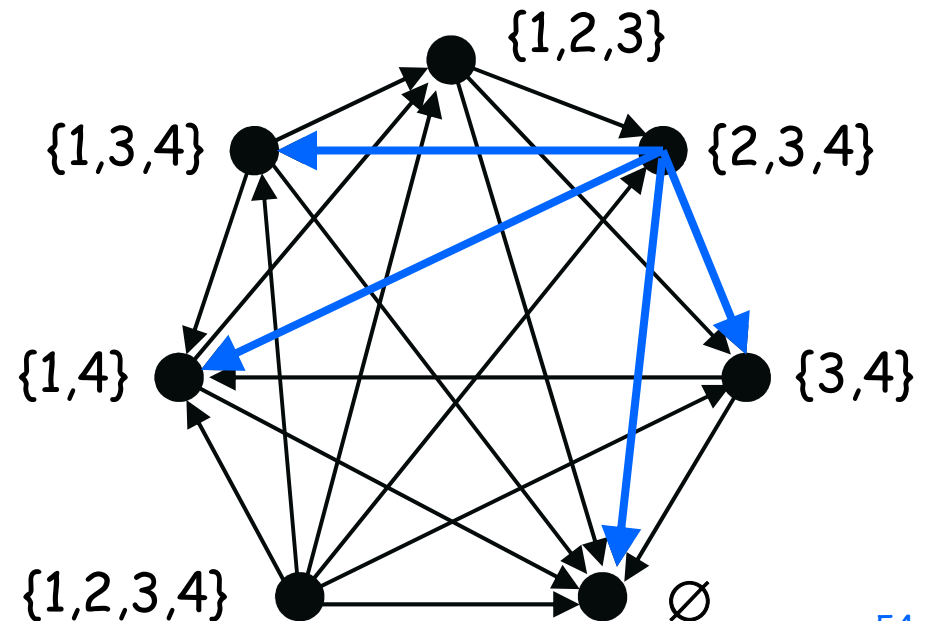

χ'_o versus χ_o (8)

Finally, let

$$\Phi(k) = \max \{ |Q(T_k)| ; T_k \text{ tournament of order } k \}$$

Theorem. If G is an oriented graph with $\chi'_o(G) = k$ then $\chi_o(G) \leq \Phi(k)$.

Moreover, this bound is tight.

Values of Φ .

k	0	1	2	3	4	5	6	7	8	9	$k \geq 10$
$\Phi(k)$	1	2	3	5	7	12	15	25	31	51	$\alpha 2^{k/2} - 1 \leq \Phi(k) \leq (\lfloor k/2 \rfloor + 2) \cdot 2^{\lfloor (k-1)/2 \rfloor}$

$$\alpha = 2 \text{ if } k \text{ is even, } \alpha = 13/(4 \cdot 2^{1/2}) \text{ if } k \text{ is odd}$$

χ'_o versus acyclic colourings

Oriented arc-colouring and acyclic colouring

Theorem [Ochem, Pinlou, S., 2007]

If G admits an acyclic k -vertex-colouring, then

$$\chi'_o(G) \leq 2k(k-1) - \lfloor k/2 \rfloor$$

($k \cdot 2^{k-1}$ for χ_o)

(Idea of) proof. We have $k(k-1)/2$ bicoloured forests, each of one being 4-arc-colourable. Among them, we select $\lfloor k/2 \rfloor$ "independent" forests which can be 3-arc-coloured.

χ'_o versus χ_o : outerplanar graphs

Outerplanar graphs

girth	χ_o	χ'_o
3	7	7
4	6	6
$5 \leq g \leq 9$	5	5
$g \geq 10$	5	4

χ'_0 versus χ_0 : planar graphs (1)

girth	χ_0	χ'_0
3	17 - 80	10 - 38
4	11 - 47	6 - 38
5	6 - 16	5 - 16
6	6 - 11	5 - 11
$7 \leq g \leq 10$	5 - 7	5 - 7
11	5 - 6	5 - 6
$12 \leq g \leq 15$	5	5
$16 \leq g \leq 45$	5	4 - 5
$g \geq 46$	5	4

χ'_0 versus χ_0 : planar graphs (2)

Open Problem F.

Determine the oriented chromatic index of the family of planar graphs.

Known to lie between 10 and 38...

Open Problem G.

Determine the smallest k for which every planar graph with girth at least k has oriented chromatic index 4.

χ'_o versus χ_o : graphs with bounded degree

Graphs with bounded degree

Theorem [Ochem, Pinlou, S., 2006]

If G has maximum degree Δ , then

$$\chi'_o(G) \leq 2 \cdot (\lfloor \Delta^2/2 \rfloor + \Delta)$$

($2 \cdot \Delta^2 \cdot 2^\Delta$ for χ_o)

For every Δ , there exists oriented graphs with oriented chromatic index $2\Delta - 1$.

Thank you for your attention!

Open Problem A. Determine the oriented chromatic number of the family of connected graphs with degree at most 3.

Open Problem B. Determine the oriented chromatic number of the family of planar graphs.

Open Problem C. Determine the oriented chromatic number of the family of triangle-free planar graphs.

Open Problem D. Determine the oriented chromatic number of the family of 2-dimensional grids.

Open Problem E. Determine the oriented chromatic number of the family of hypercubes.

Open Problem F. Determine the oriented chromatic index of the family of planar graphs.

Open Problem G. Determine the smallest k for which every planar graph with girth at least k has oriented chromatic index 4.