

Homomorphisms and colourings of oriented graphs

Éric SOPENA

LaBRI, Bordeaux University

France

DISCRETE MATH DAYS AND ONTARIO COMBINATORICS WORKSHOP

21–24 May 2015

University of Ottawa

Outline

- Preliminary (basic) notions
- Homomorphisms and colourings of oriented graphs
(oriented chromatic number, oriented cliques, oriented clique numbers, complexity)
- Simple colourings
- 2-dipath colourings
- Some open problems

Colourings of undirected graphs

A (proper) *k-colouring* of a (simple, loopless) graph G is a mapping

$$c : V(G) \rightarrow \{1, 2, \dots, k\}$$

such that every two *adjacent vertices* are assigned *distinct colours*.

Preliminary (basic) notions

(1)

Colourings of undirected graphs

A (proper) *k-colouring* of a (simple, loopless) graph G is a mapping

$$c : V(G) \rightarrow \{1, 2, \dots, k\}$$

such that every two *adjacent vertices* are assigned *distinct colours*.

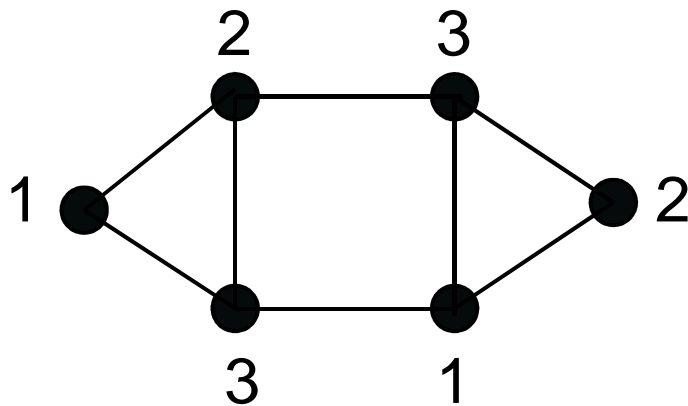

Preliminary (basic) notions

(1)

Colourings of undirected graphs

A (proper) *k*-colouring of a (simple, loopless) graph G is a mapping

$$c : V(G) \rightarrow \{1, 2, \dots, k\}$$

such that every two *adjacent vertices* are assigned *distinct colours*.

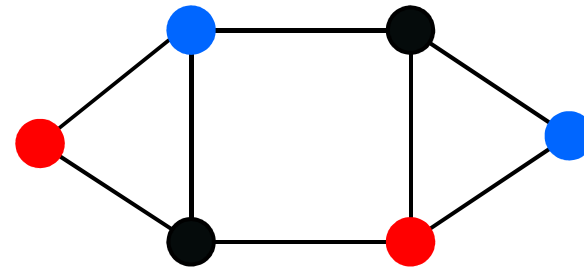
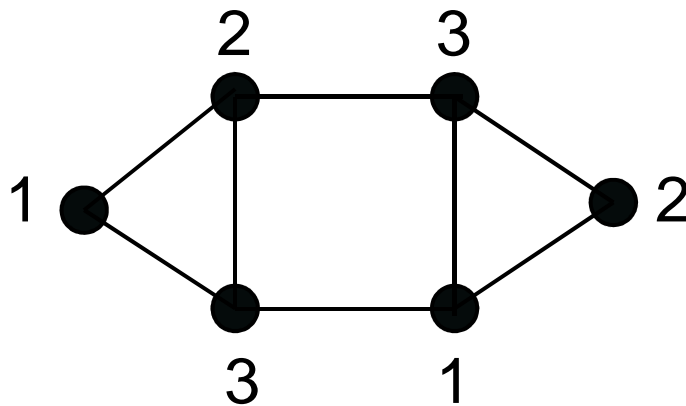

Preliminary (basic) notions

(1)

Colourings of undirected graphs

A (proper) *k*-colouring of a (simple, loopless) graph G is a mapping

$$c : V(G) \rightarrow \{1, 2, \dots, k\}$$

such that every two *adjacent vertices* are assigned *distinct colours*.

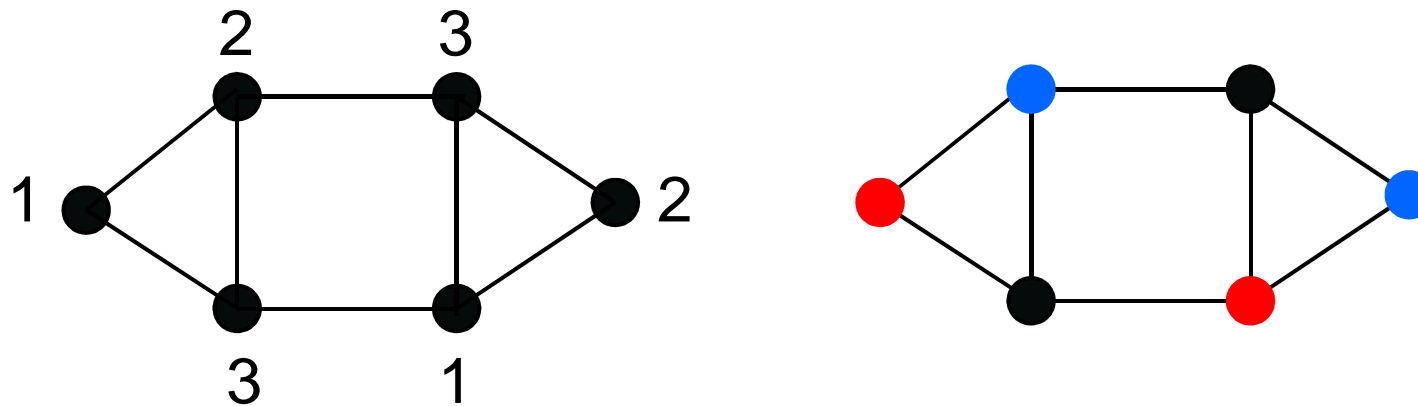

The *chromatic number* $\chi(G)$ of G is the smallest k for which G has a k -colouring.

Preliminary (basic) notions

(1)

Colourings of undirected graphs

A (proper) *k*-colouring of a (simple, loopless) graph G is a mapping

$$c : V(G) \rightarrow \{1, 2, \dots, k\}$$

such that every two *adjacent vertices* are assigned *distinct colours*.

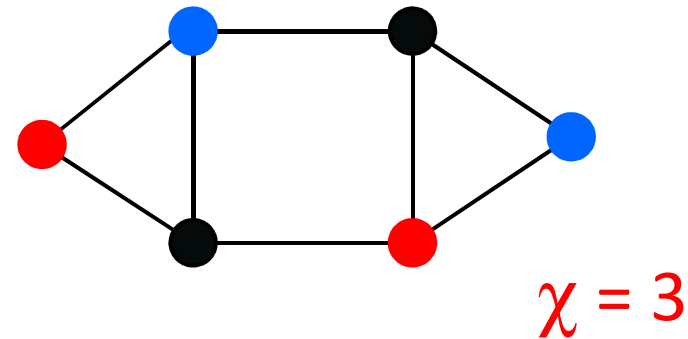
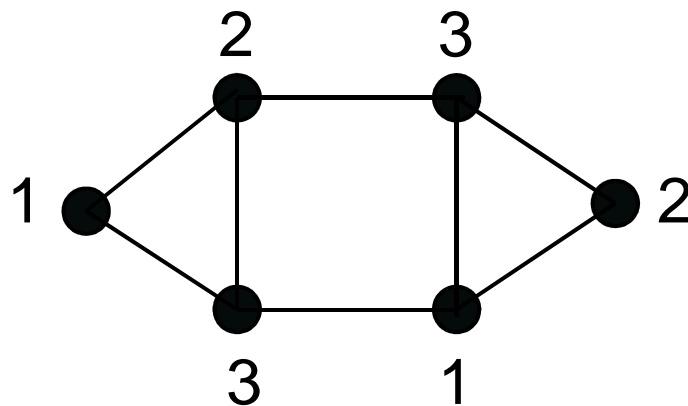

The *chromatic number* $\chi(G)$ of G is the smallest k for which G has a k -colouring.

Homomorphisms of undirected graphs

A **homomorphism** from G to H is a mapping $h : V(G) \rightarrow V(H)$ such that :

$$xy \in E(G) \Rightarrow h(x)h(y) \in E(H)$$

Homomorphisms of undirected graphs

A **homomorphism** from G to H is a mapping $h : V(G) \rightarrow V(H)$ such that :

$$xy \in E(G) \Rightarrow h(x)h(y) \in E(H)$$

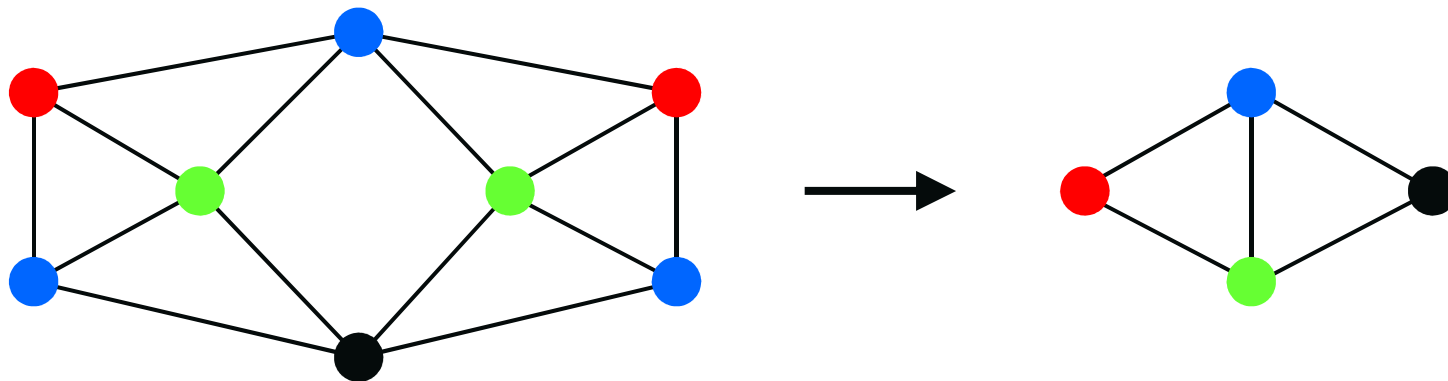

Homomorphisms of undirected graphs

A **homomorphism** from G to H is a mapping $h : V(G) \rightarrow V(H)$ such that :

$$xy \in E(G) \Rightarrow h(x)h(y) \in E(H)$$

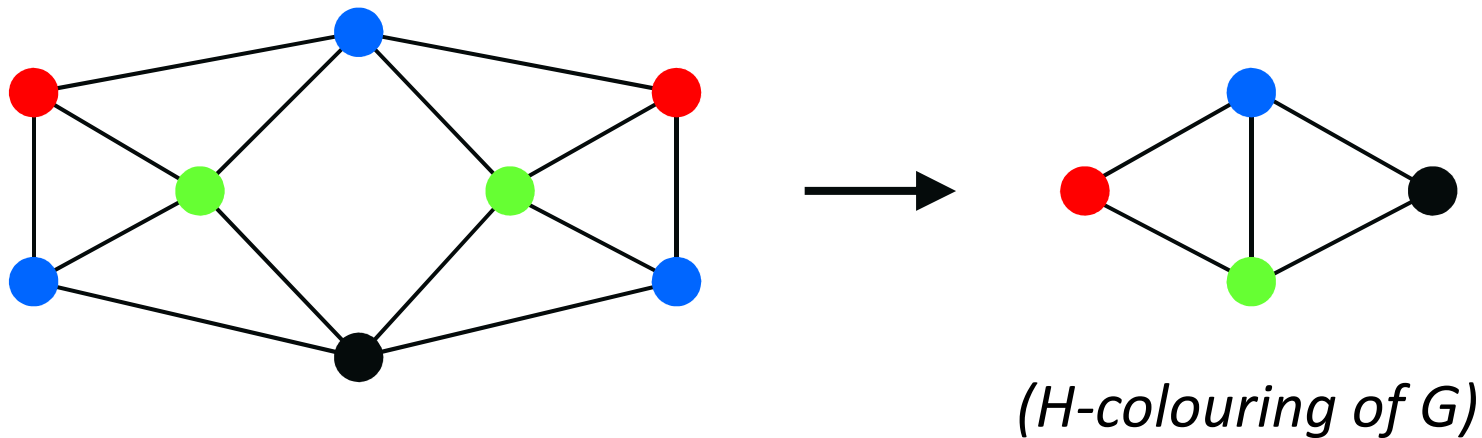

Preliminary (basic) notions

(2)

Homomorphisms of undirected graphs

A **homomorphism** from G to H is a mapping $h : V(G) \rightarrow V(H)$ such that :

$$xy \in E(G) \Rightarrow h(x)h(y) \in E(H)$$

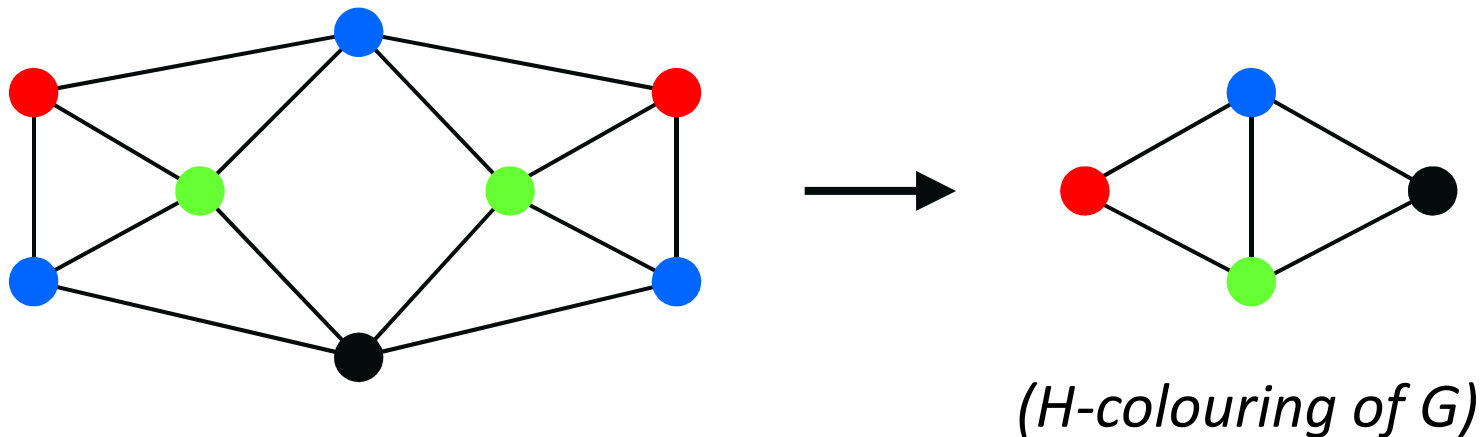

Notation.

$G \rightarrow H$: there exists a homomorphism from G to H

Colourings vs homomorphisms

A k -colouring of G is nothing but a *homomorphism* from G to K_k , the *complete graph* on k vertices.

Colourings vs homomorphisms

A k -colouring of G is nothing but a *homomorphism* from G to K_k , the *complete graph* on k vertices.

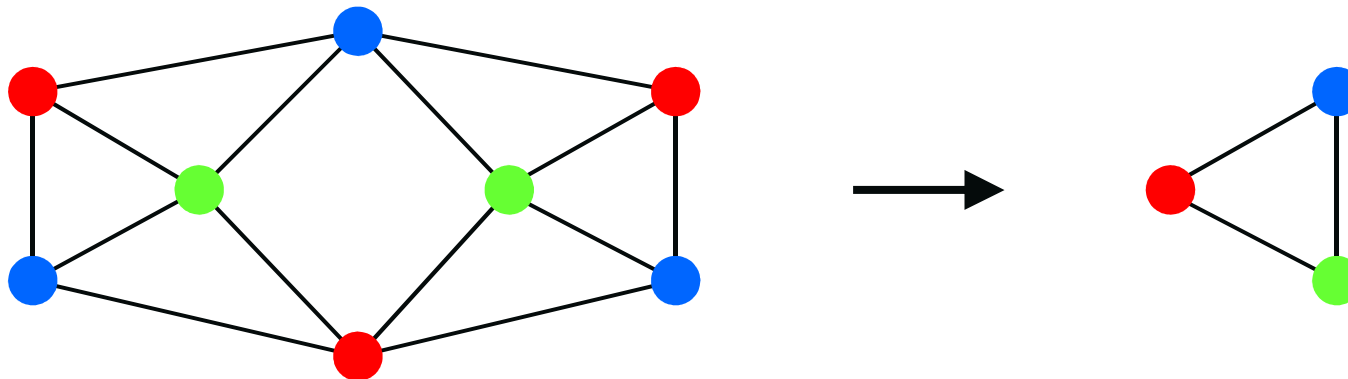

Colourings vs homomorphisms

A k -colouring of G is nothing but a *homomorphism* from G to K_k , the *complete graph* on k vertices.

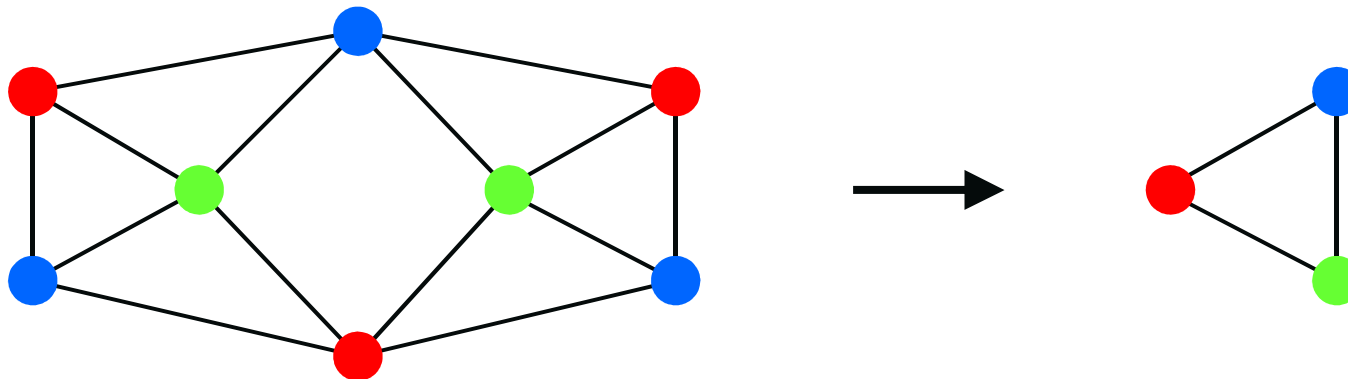

Remark.

$\chi(G) = k$ if and only if $G \rightarrow K_k$ and $G \not\rightarrow K_{k-1}$

Oriented graphs

An **oriented graph** is an *antisymmetric* (simple, loopless) digraph (no directed cycle of length 1 or 2).

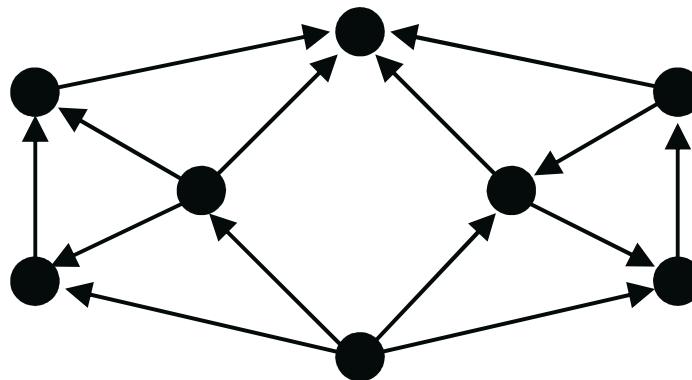

Oriented graphs

An **oriented graph** is an *antisymmetric* (simple, loopless) digraph (no directed cycle of length 1 or 2).

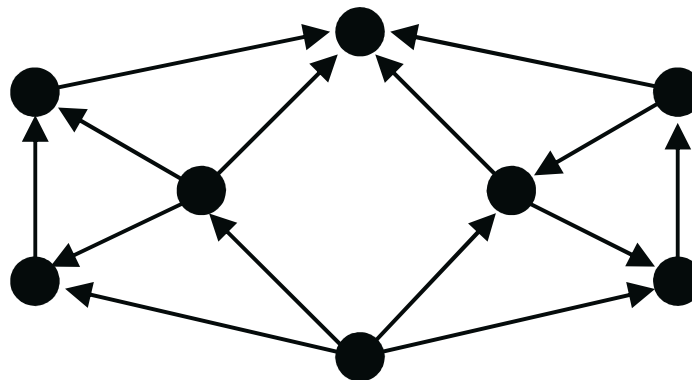

An oriented graph is an *orientation* of its underlying undirected graph, obtained by giving to each edge one of its two possible orientations.

Homomorphisms of oriented graphs

A **homomorphism** from G to H is a mapping $h : V(G) \rightarrow V(H)$ such that :

$$xy \in E(G) \Rightarrow h(x)h(y) \in E(H)$$

Homomorphisms of oriented graphs

A **homomorphism** from G to H is a mapping $h : V(G) \rightarrow V(H)$ such that :

$$xy \in E(G) \Rightarrow h(x)h(y) \in E(H)$$

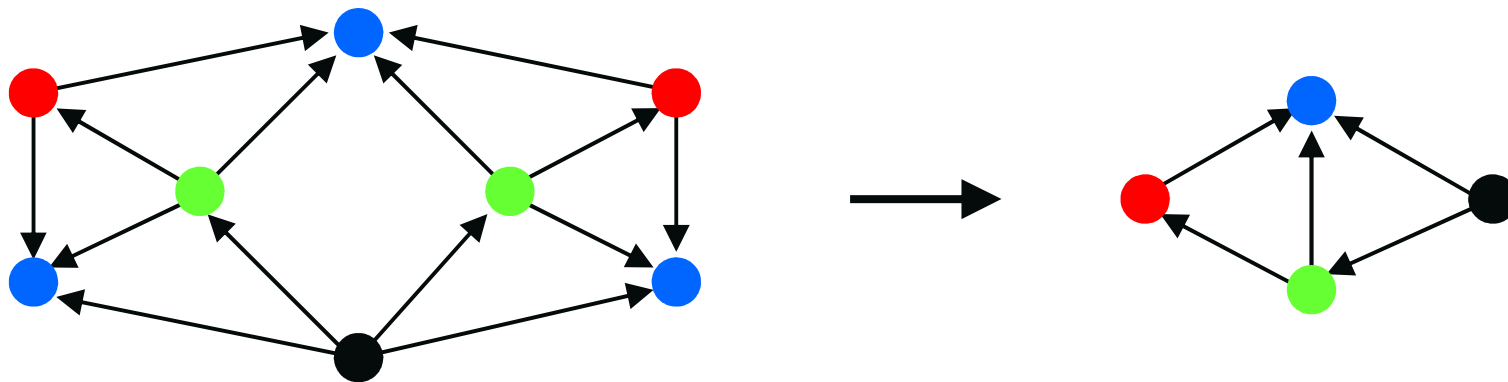

Oriented colourings of oriented graphs

An **oriented k -colouring** of an oriented graph G is a mapping

$$c : V(G) \rightarrow \{1, 2, \dots, k\}$$

such that:

Oriented colourings of oriented graphs

An **oriented k -colouring** of an oriented graph G is a mapping

$$c : V(G) \rightarrow \{1, 2, \dots, k\}$$

such that:

$$(1) uv \in E(G) \Rightarrow c(u) \neq c(v)$$

$$(2) uv, xy \in E(G), c(u) = c(y) \Rightarrow c(v) \neq c(x)$$

Oriented colourings

(1)

Oriented colourings of oriented graphs

An **oriented k -colouring** of an oriented graph G is a mapping

$$c : V(G) \rightarrow \{1, 2, \dots, k\}$$

such that:

$$(1) uv \in E(G) \Rightarrow c(u) \neq c(v)$$

$$(2) uv, xy \in E(G), c(u) = c(y) \Rightarrow c(v) \neq c(x)$$

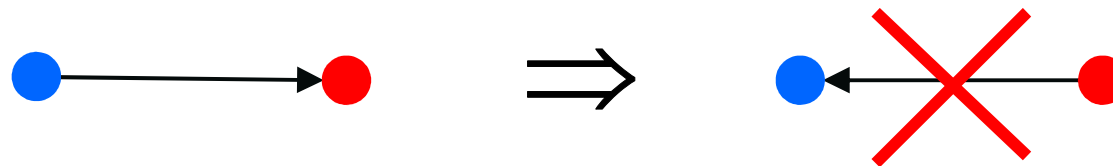

Oriented colourings

(1)

Oriented colourings of oriented graphs

An **oriented k -colouring** of an oriented graph G is a mapping

$$c : V(G) \rightarrow \{1, 2, \dots, k\}$$

such that:

$$(1) uv \in E(G) \Rightarrow c(u) \neq c(v)$$

$$(2) uv, xy \in E(G), c(u) = c(y) \Rightarrow c(v) \neq c(x)$$

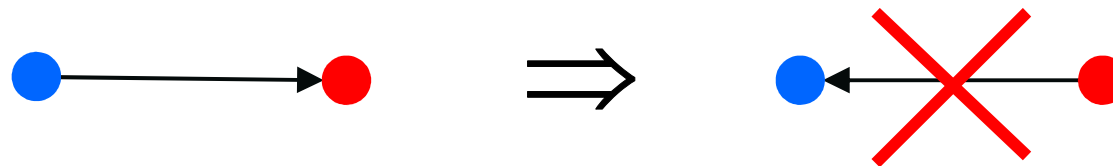

Hence, all the arcs linking two colour classes (independent sets) **must have the same direction** (non-local condition...).

Oriented colourings

(2)

Examples.



Oriented colourings

(2)

Examples.



*Any two vertices linked
by a directed path of length 1 or 2
must get distinct colours.*

Oriented colourings

(2)

Examples.



Any two vertices linked by a directed path of length 1 or 2 must get distinct colours.

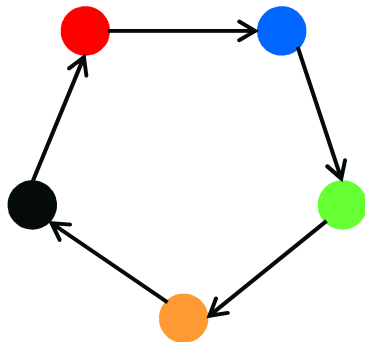

Oriented colourings

(2)

Examples.



Any two vertices linked by a directed path of length 1 or 2 must get distinct colours.

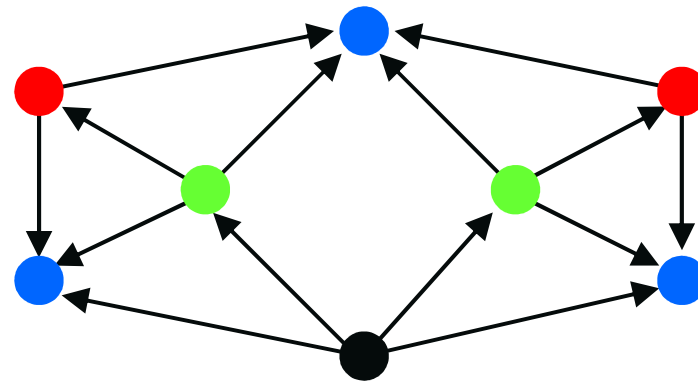
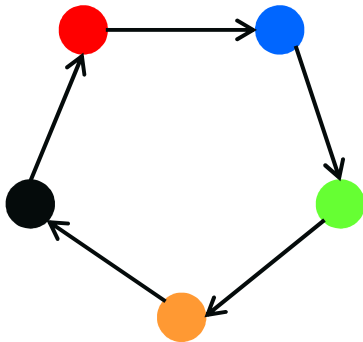

Oriented colourings

(3)

Remark.

An oriented k -colouring of an oriented graph is nothing but a *homomorphism* to a given oriented graph (or *tournament*) with k vertices.

Oriented colourings

(3)

Remark.

An oriented k -colouring of an oriented graph is nothing but a *homomorphism* to a given oriented graph (or *tournament*) with k vertices.

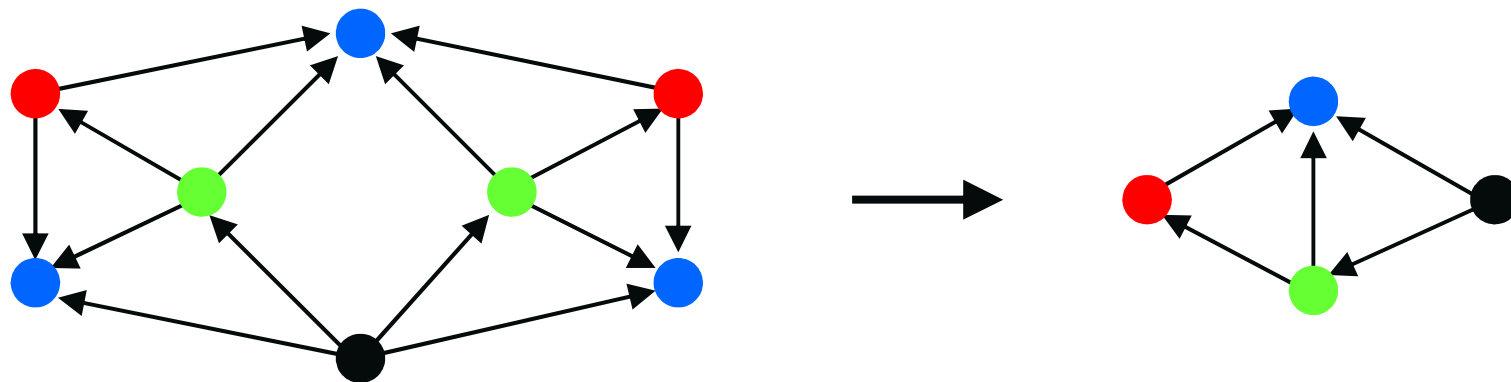

The target graph gives the orientation of arcs linking any two colour classes...

Oriented chromatic number of oriented graphs

The **oriented chromatic number** $\chi_o(G)$ of an oriented graph G is the smallest k for which G admits an oriented k -colouring.

(Or, equivalently, the smallest order of an oriented graph H such that $G \rightarrow H$)

Oriented chromatic number of oriented graphs

The **oriented chromatic number** $\chi_o(G)$ of an oriented graph G is the smallest k for which G admits an oriented k -colouring.

(Or, equivalently, the smallest order of an oriented graph H such that $G \rightarrow H$)

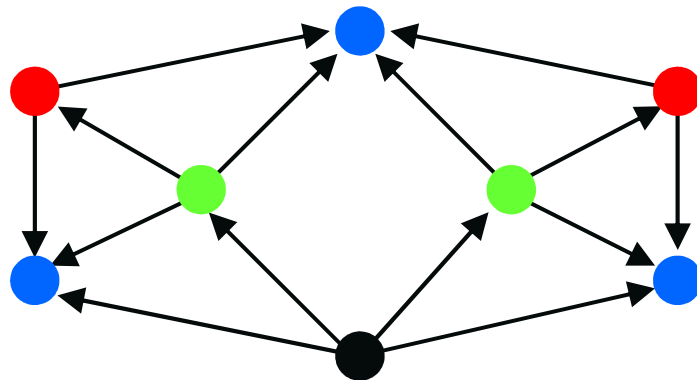

$$\chi_o = 4$$

Oriented chromatic number of undirected graphs

The **oriented chromatic number** $\chi_o(U)$ of an *undirected* graph U is the smallest k for which *every orientation* of U admits an oriented k -colouring:

$$\chi_o(U) = \max \{ \chi_o(G) ; G \text{ is an orientation of } U \}$$

Oriented chromatic number of undirected graphs

The **oriented chromatic number** $\chi_o(U)$ of an *undirected* graph U is the smallest k for which *every orientation* of U admits an oriented k -colouring:

$$\chi_o(U) = \max \{ \chi_o(G) ; G \text{ is an orientation of } U \}$$

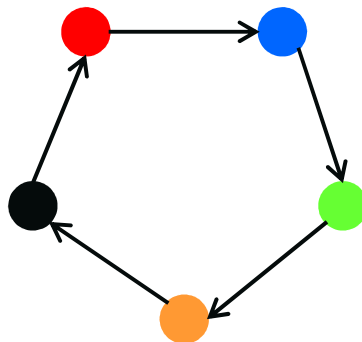
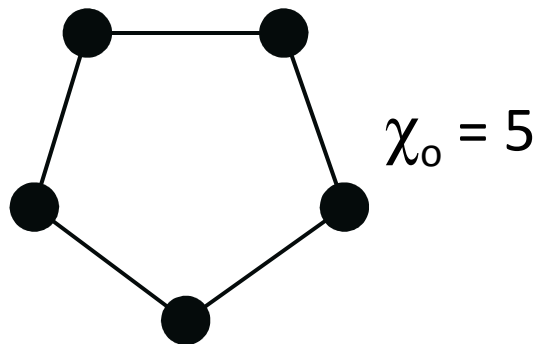

Oriented chromatic number of undirected graphs

The **oriented chromatic number** $\chi_o(U)$ of an *undirected* graph U is the smallest k for which *every orientation* of U admits an oriented k -colouring:

$$\chi_o(U) = \max \{ \chi_o(G) ; G \text{ is an orientation of } U \}$$

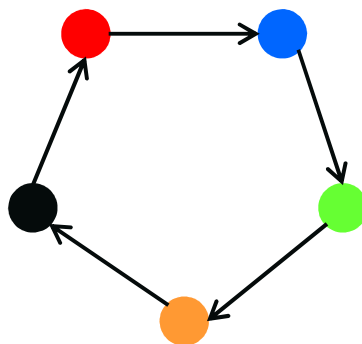
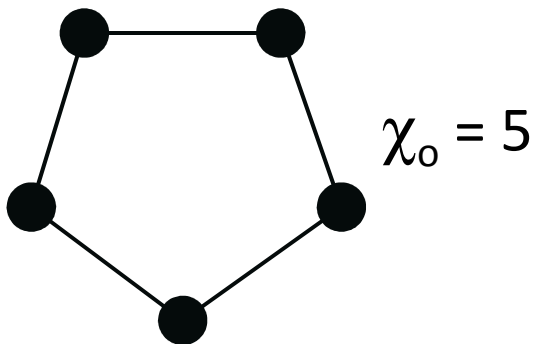

Observation.

$$\chi(U) = \min \{ \dots \}$$

χ_o of some graph classes

(1)

➤ If G is a forest, then $\chi_o(G) \leq 3$

(easy)

χ_o of some graph classes

(1)

➤ If G is a forest, then $\chi_o(G) \leq 3$

(easy)

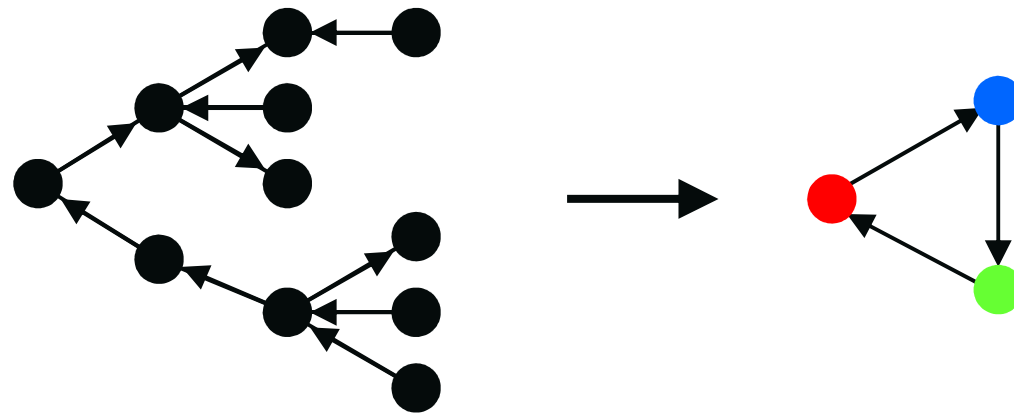

χ_o of some graph classes

(1)

➤ If G is a forest, then $\chi_o(G) \leq 3$

(easy)

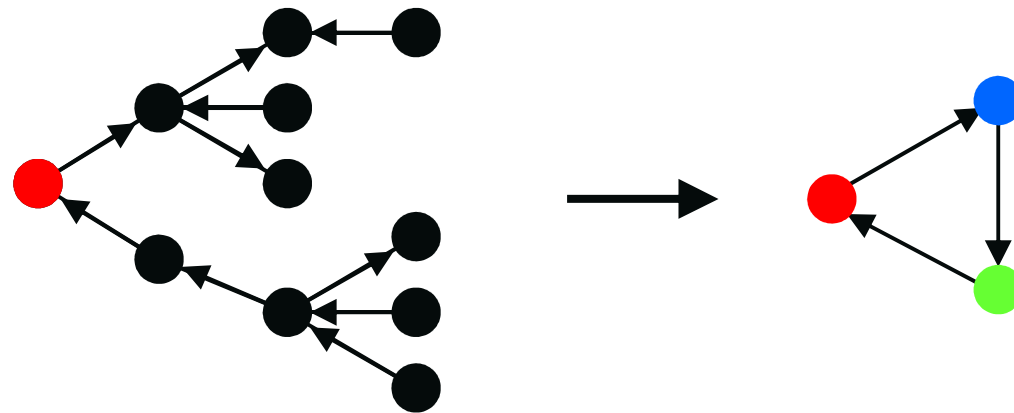

χ_o of some graph classes

(1)

➤ If G is a forest, then $\chi_o(G) \leq 3$

(easy)

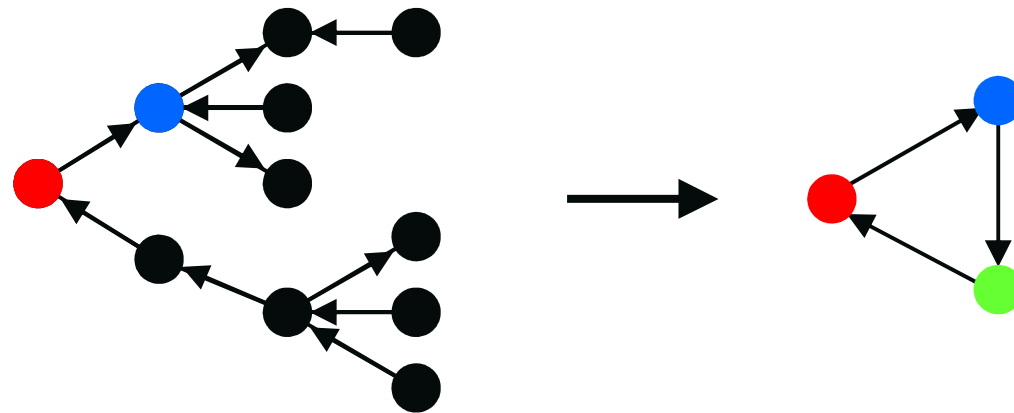

χ_o of some graph classes

(1)

➤ If G is a forest, then $\chi_o(G) \leq 3$

(easy)

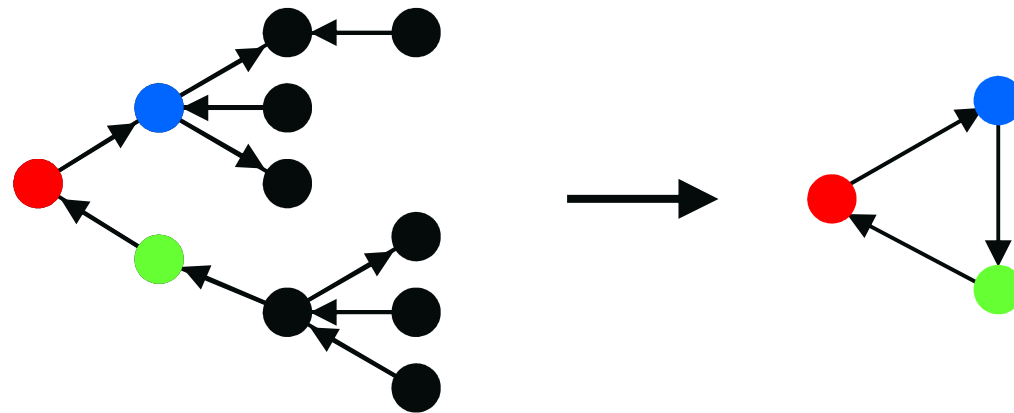

χ_o of some graph classes

(1)

➤ If G is a forest, then $\chi_o(G) \leq 3$

(easy)

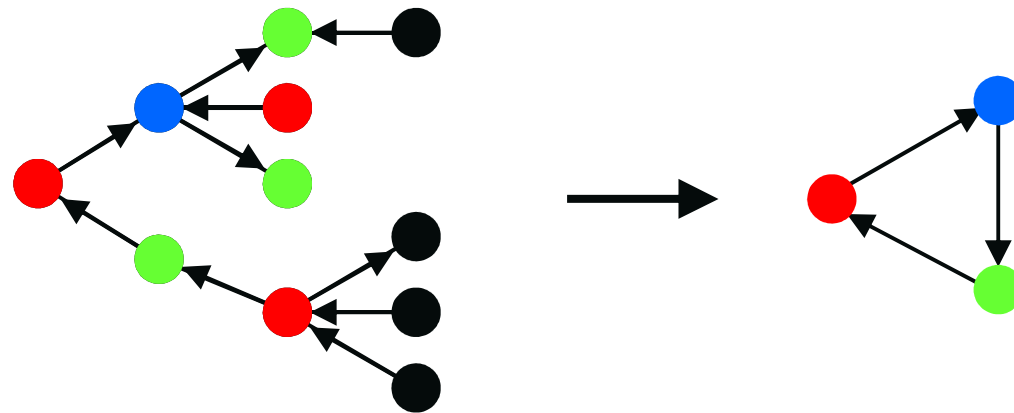

χ_o of some graph classes

(1)

➤ If G is a forest, then $\chi_o(G) \leq 3$

(easy)

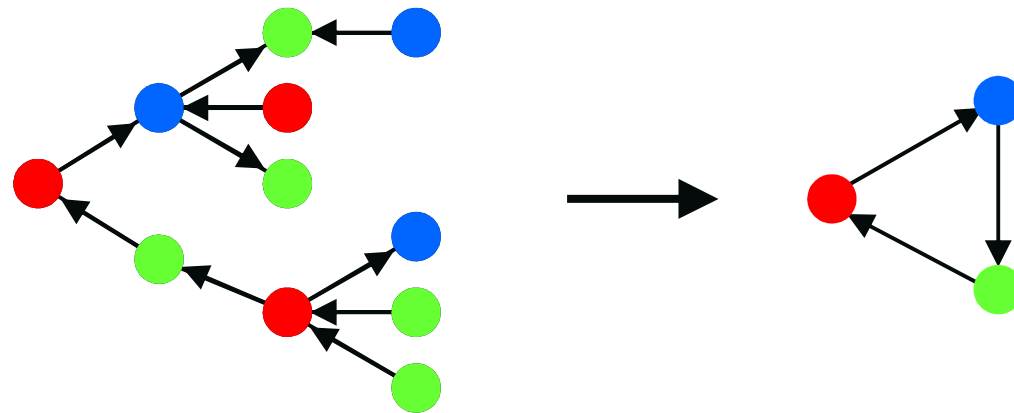

χ_o of some graph classes

(1)

- If G is a **forest**, then $\chi_o(G) \leq 3$ (easy)
- **Theorem.** If G is an **outerplanar graph**, then $\chi_o(G) \leq 7$
(and this bound is tight)

χ_o of some graph classes

(1)

- If G is a **forest**, then $\chi_o(G) \leq 3$ (easy)
- **Theorem.** If G is an **outerplanar graph**, then $\chi_o(G) \leq 7$
(and this bound is tight)

The target graph is the tournament QR_7 , defined as follows:

- $V(QR_7) = \{0, 1, \dots, 6\}$
- $uv \in E(QR_7)$ iff $v - u \pmod{7} = 1, 2$ or 4
(non-zero quadratic residues of 7)

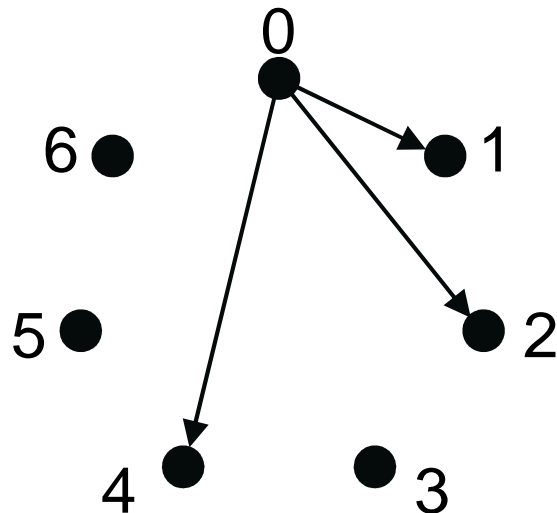

χ_o of some graph classes

(1)

- If G is a forest, then $\chi_o(G) \leq 3$ (easy)
- **Theorem.** If G is an outerplanar graph, then $\chi_o(G) \leq 7$ (and this bound is tight)

The target graph is the tournament QR_7 , defined as follows:

- $V(QR_7) = \{0, 1, \dots, 6\}$

- $uv \in E(QR_7)$ iff $v - u \pmod{7} = 1, 2$ or 4

(non-zero quadratic residues of 7)

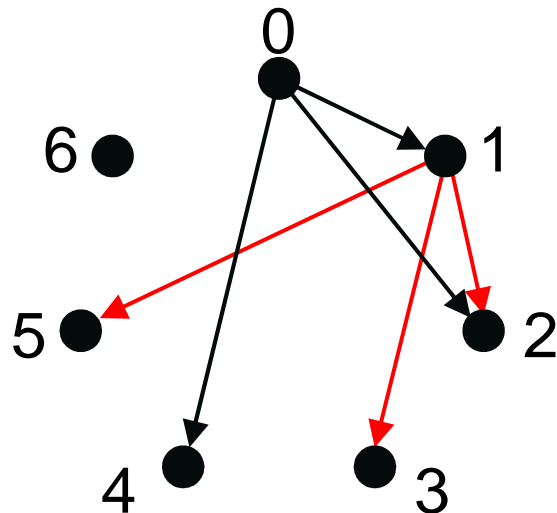

χ_o of some graph classes

(1)

- If G is a forest, then $\chi_o(G) \leq 3$ (easy)
- **Theorem.** If G is an outerplanar graph, then $\chi_o(G) \leq 7$ (and this bound is tight)

The target graph is the tournament QR_7 , defined as follows:

- $V(QR_7) = \{0, 1, \dots, 6\}$
- $uv \in E(QR_7)$ iff $v - u \pmod{7} = 1, 2$ or 4 (non-zero quadratic residues of 7)

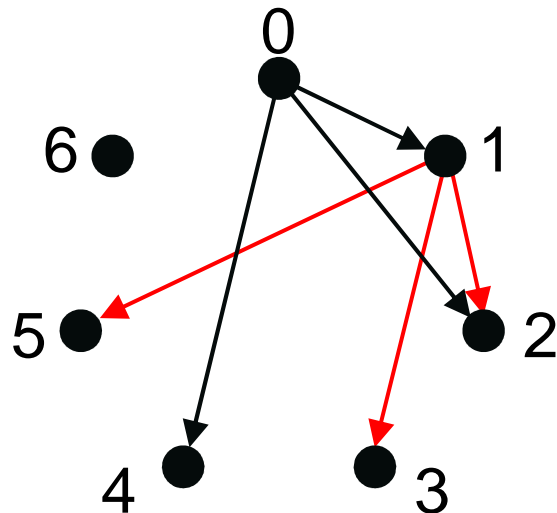

Property. For every arc $uv \in E(QR_7)$, there exists a vertex w for every possible orientation of the edges uw and vw :

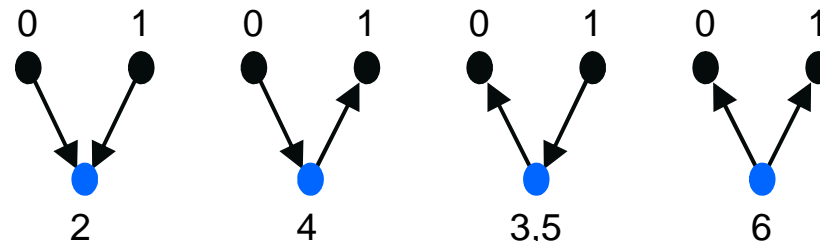

χ_o of some graph classes

(1')

- If G is a forest, then $\chi_o(G) \leq 3$ (easy)
- **Theorem.** If G is an outerplanar graph, then $\chi_o(G) \leq 7$ (and this bound is tight)

Since every outerplanar graph contains a vertex of degree at most 2 we are done...

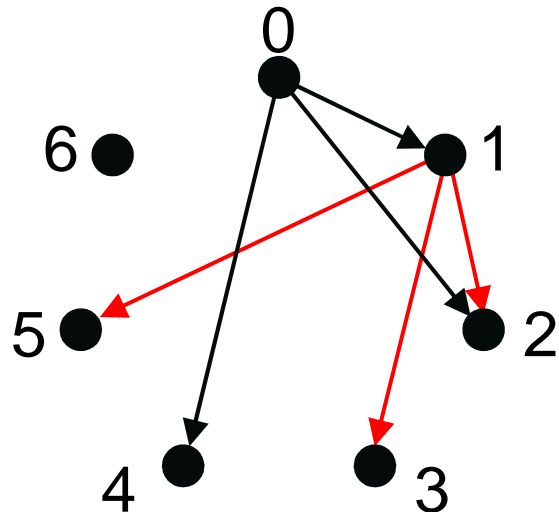
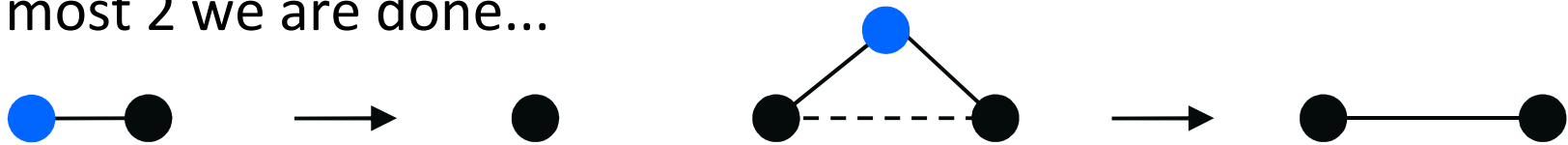

Property. For every arc $uv \in E(QR_7)$, there exists a vertex w for every possible orientation of the edges uw and vw :

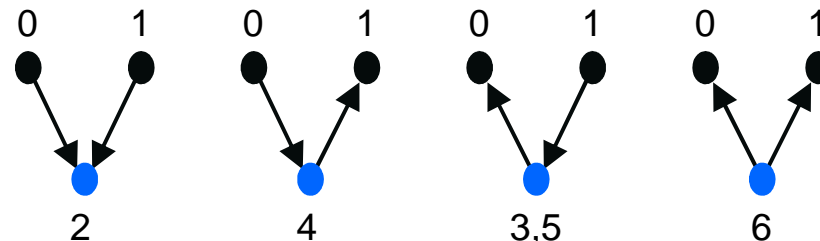

χ_o of some graph classes

(1'')

- If G is a **forest**, then $\chi_o(G) \leq 3$ (easy)
- **Theorem.** If G is an **outerplanar graph**, then $\chi_o(G) \leq 7$ (and this bound is tight)

An outerplanar graph with oriented chromatic number 7:

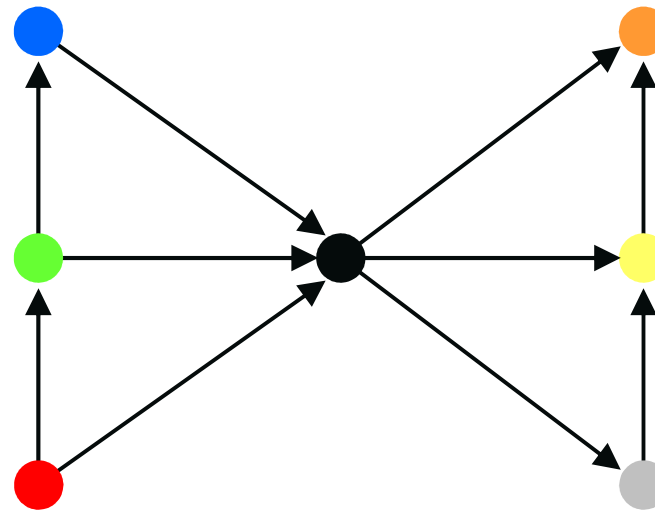

Graphs with bounded acyclic chromatic number

A k -colouring of an undirected graph U is **acyclic** if every cycle in U uses *at least 3 colours*.

(In other words, any two colours induce a forest.)

Graphs with bounded acyclic chromatic number

A k -colouring of an undirected graph U is **acyclic** if every cycle in U uses *at least 3 colours*.

(In other words, any two colours induce a forest.)

- **Theorem.** Every planar graph admits an acyclic 5-coloring
(*and this bound is tight*) (Borodin, 1979)

Graphs with bounded acyclic chromatic number

A k -colouring of an undirected graph U is **acyclic** if every cycle in U uses *at least 3 colours*.

(In other words, any two colours induce a forest.)

- **Theorem.** Every planar graph admits an acyclic 5-coloring
(*and this bound is tight*) (Borodin, 1979)

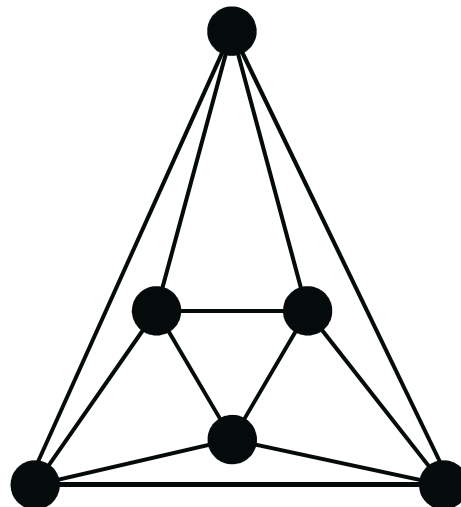

Graphs with bounded acyclic chromatic number

A k -colouring of an undirected graph U is **acyclic** if every cycle in U uses *at least 3 colours*.

(In other words, any two colours induce a forest.)

- **Theorem.** Every planar graph admits an acyclic 5-coloring
(*and this bound is tight*) (Borodin, 1979)

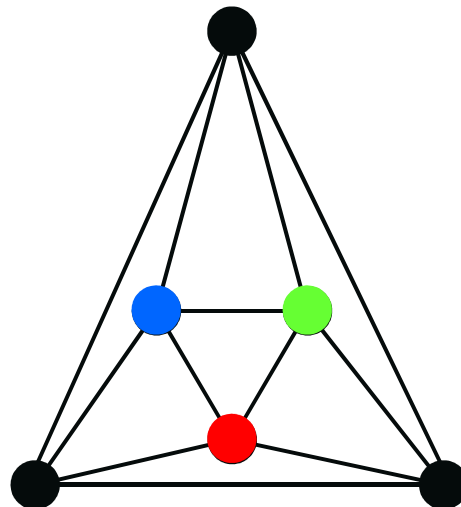

Graphs with bounded acyclic chromatic number

A k -colouring of an undirected graph U is **acyclic** if every cycle in U uses *at least 3 colours*.

(In other words, any two colours induce a forest.)

- **Theorem.** Every planar graph admits an acyclic 5-coloring
(*and this bound is tight*) (Borodin, 1979)

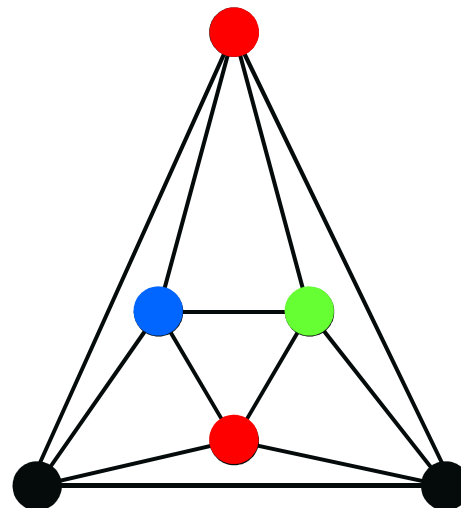

Graphs with bounded acyclic chromatic number

A k -colouring of an undirected graph U is **acyclic** if every cycle in U uses *at least 3 colours*.

(In other words, any two colours induce a forest.)

- **Theorem.** Every planar graph admits an acyclic 5-coloring
(*and this bound is tight*) (Borodin, 1979)

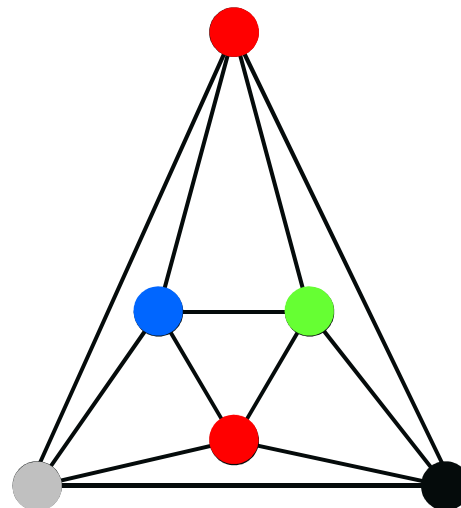

Graphs with bounded acyclic chromatic number

A k -colouring of an undirected graph U is **acyclic** if every cycle in U uses *at least 3 colours*.

(In other words, any two colours induce a forest.)

- **Theorem.** Every planar graph admits an acyclic 5-coloring
(*and this bound is tight*) (Borodin, 1979)

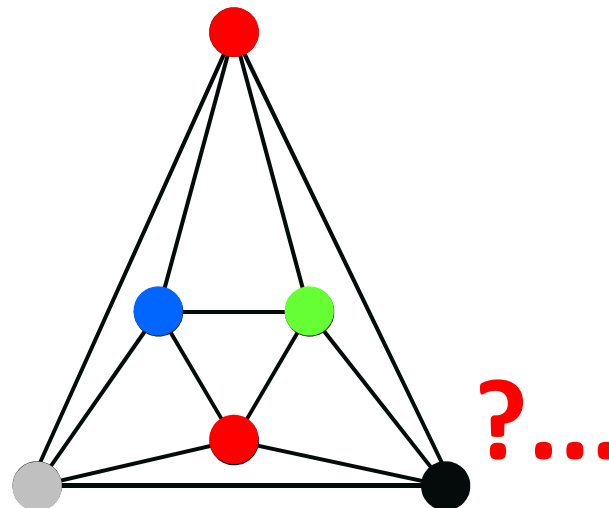

Graphs with bounded acyclic chromatic number

A k -colouring of an undirected graph U is **acyclic** if every cycle in U uses *at least 3 colours*.

(In other words, any two colours induce a forest.)

➤ **Theorem.** Every planar graph admits an acyclic 5-coloring
(*and this bound is tight*) (Borodin, 1979)

➤ **Theorem.** If G has acyclic chromatic number at most k , then
 $\chi_o(G) \leq k \cdot 2^{k-1}$ (Raspaud, S., 1994)

(and this bound is tight)

(Ochem, 2005)

Graphs with bounded acyclic chromatic number

A k -colouring of an undirected graph U is **acyclic** if every cycle in U uses *at least 3 colours*.

(In other words, any two colours induce a forest.)

➤ **Theorem.** Every planar graph admits an acyclic 5-coloring
(*and this bound is tight*) (Borodin, 1979)

➤ **Theorem.** If G has acyclic chromatic number at most k , then
 $\chi_o(G) \leq k \cdot 2^{k-1}$ (Raspaud, S., 1994)
(*and this bound is tight*)

(Ochem, 2005)

➤ **Corollary.** If G is planar, then $\chi_o(G) \leq 80$

Graphs with bounded acyclic chromatic number

A k -colouring of an undirected graph U is **acyclic** if every cycle in U uses *at least 3 colours*.

(In other words, any two colours induce a forest.)

➤ **Theorem.** Every planar graph admits an acyclic 5-coloring
(*and this bound is tight*) (Borodin, 1979)

➤ **Theorem.** If G has acyclic chromatic number at most k , then
 $\chi_o(G) \leq k \cdot 2^{k-1}$ (Raspaud, S., 1994)
(*and this bound is tight*)

(Ochem, 2005)

➤ **Corollary.** If G is planar, then $\chi_o(G) \leq 80$
Best known lower bound : 18 (Marshall, 2012)

Graphs with bounded acyclic chromatic number

➤ **Theorem.** If G has acyclic chromatic number at most k , then

$$\chi_o(G) \leq k \cdot 2^{k-1}$$

(Raspaud, S., 1994)

Sketch of proof.

Graphs with bounded acyclic chromatic number

➤ **Theorem.** If G has acyclic chromatic number at most k , then

$$\chi_o(G) \leq k \cdot 2^{k-1}$$

(Raspaud, S., 1994)

Sketch of proof.

Let G be a graph and c a k -acyclic colouring of G .

Graphs with bounded acyclic chromatic number

➤ **Theorem.** If G has acyclic chromatic number at most k , then

$$\chi_o(G) \leq k \cdot 2^{k-1}$$

(Raspaud, S., 1994)

Sketch of proof.

Let G be a graph and c a k -acyclic colouring of G .

Let a, b be any two colours with $a < b$ and H be any orientation of G .

Consider the subgraph $H_{a,b}$ induced by vertices *with colour a or b*

($H_{a,b}$ is a forest).

Graphs with bounded acyclic chromatic number

➤ **Theorem.** If G has acyclic chromatic number at most k , then

$$\chi_o(G) \leq k \cdot 2^{k-1}$$

(Raspaud, S., 1994)

Sketch of proof.

Let G be a graph and c a k -acyclic colouring of G .

Let a, b be any two colours with $a < b$ and H be any orientation of G .

Consider the subgraph $H_{a,b}$ induced by vertices *with colour a or b*

($H_{a,b}$ is a forest).

$a < b$

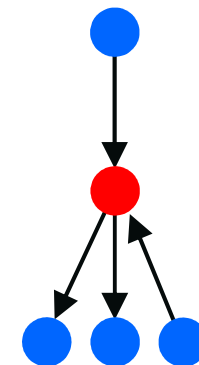
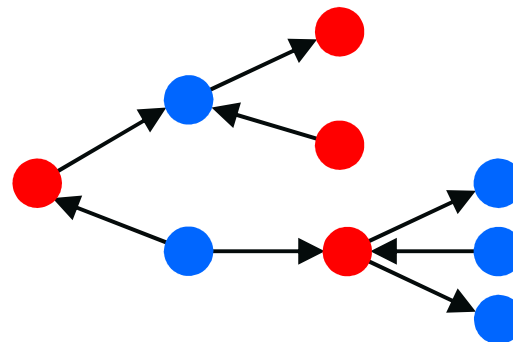

Graphs with bounded acyclic chromatic number

➤ **Theorem.** If G has acyclic chromatic number at most k , then

$$\chi_o(G) \leq k \cdot 2^{k-1}$$

(Raspaud, S., 1994)

Sketch of proof.

Choose a vertex (root) in each component of $H_{a,b}$.

$a < b$

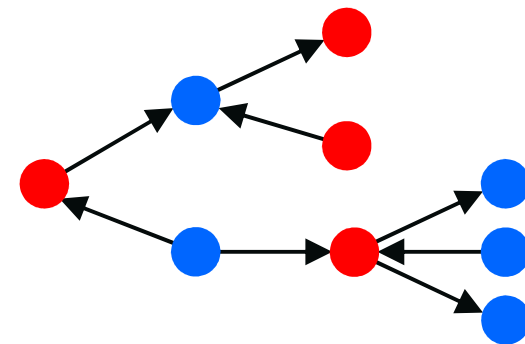

Graphs with bounded acyclic chromatic number

➤ **Theorem.** If G has acyclic chromatic number at most k , then

$$\chi_o(G) \leq k \cdot 2^{k-1}$$

(Raspaud, S., 1994)

Sketch of proof.

Choose a vertex (root) in each component of $H_{a,b}$.

Associate a bit with value **0** with each of them.

$a < b$

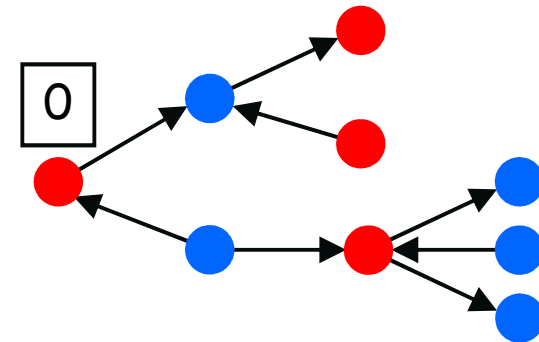

χ_o of some graph classes

(2)

Graphs with bounded acyclic chromatic number

- **Theorem.** If G has acyclic chromatic number at most k , then

$$\chi_o(G) \leq k \cdot 2^{k-1}$$

(Raspaud, S., 1994)

Sketch of proof.

Choose a vertex (root) in each component of $H_{a,b}$.

Associate a bit with value **0** with each of them.

Apply the following rule:

 ($a < b$) : keep the same bit

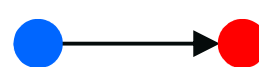
 ($b > a$) : change the bit

$a < b$

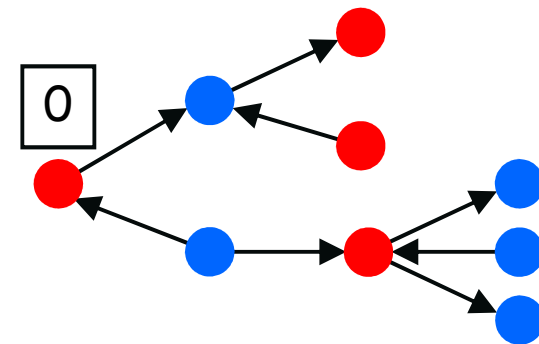

Graphs with bounded acyclic chromatic number

➤ **Theorem.** If G has acyclic chromatic number at most k , then

$$\chi_o(G) \leq k \cdot 2^{k-1}$$

(Raspaud, S., 1994)

Sketch of proof.

Choose a vertex (root) in each component of $H_{a,b}$.

Associate a bit with value **0** with each of them.

Apply the following rule:

 ($a < b$) : keep the same bit

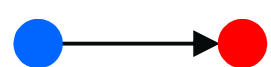
 ($b > a$) : change the bit

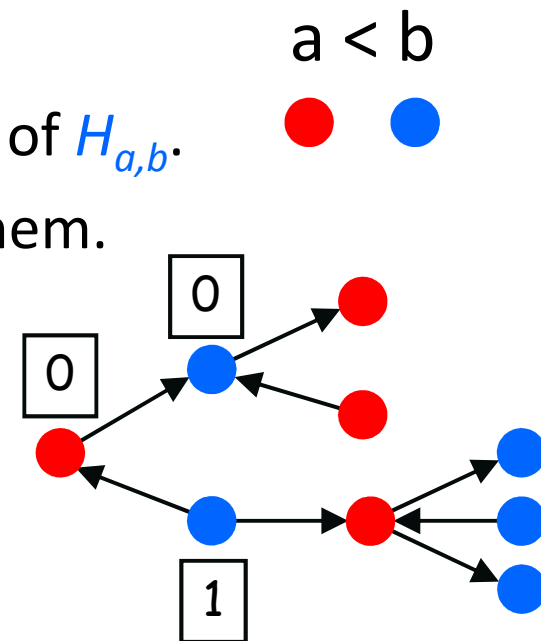

χ_o of some graph classes

(2)

Graphs with bounded acyclic chromatic number

➤ **Theorem.** If G has acyclic chromatic number at most k , then

$$\chi_o(G) \leq k \cdot 2^{k-1}$$

(Raspaud, S., 1994)

Sketch of proof.

Choose a vertex (root) in each component of $H_{a,b}$.

Associate a bit with value 0 with each of them.

Apply the following rule:

 ($a < b$) : keep the same bit

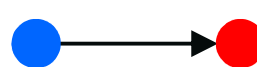
 ($b > a$) : change the bit

$a < b$

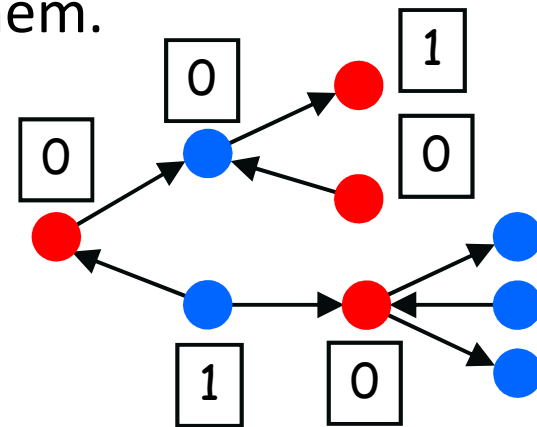

Graphs with bounded acyclic chromatic number

➤ **Theorem.** If G has acyclic chromatic number at most k , then

$$\chi_o(G) \leq k \cdot 2^{k-1}$$

(Raspaud, S., 1994)

Sketch of proof.

Choose a vertex (root) in each component of $H_{a,b}$.

Associate a bit with value **0** with each of them.

Apply the following rule:

 ($a < b$) : keep the same bit

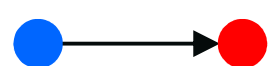
 ($b > a$) : change the bit

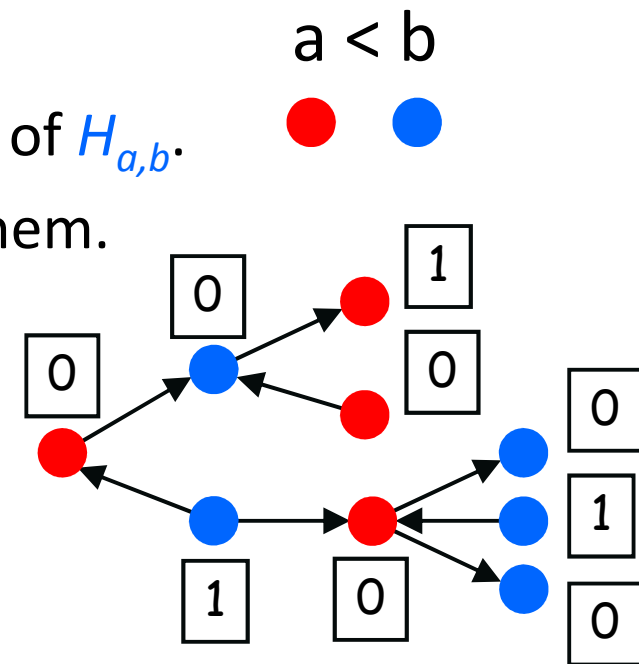

Graphs with bounded acyclic chromatic number

- **Theorem.** If G has acyclic chromatic number at most k , then

$$\chi_o(G) \leq k \cdot 2^{k-1}$$

(Raspaud, S., 1994)

Sketch of proof.

Doing that, we have constructed a homomorphism from $H_{a,b}$ to the 2-coloured directed 4-cycle.

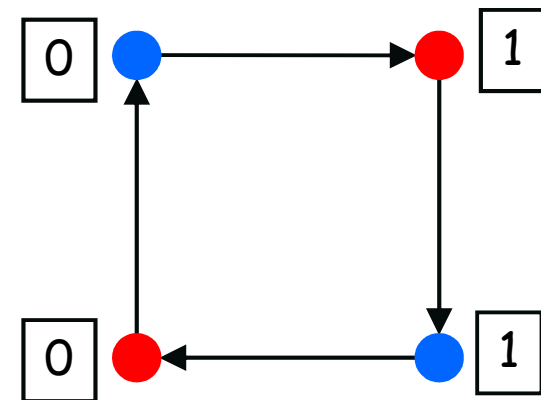

Graphs with bounded acyclic chromatic number

- **Theorem.** If G has acyclic chromatic number at most k , then

$$\chi_o(G) \leq k \cdot 2^{k-1}$$

(Raspaud, S., 1994)

Sketch of proof.

Doing that, we have constructed a homomorphism from $H_{a,b}$ to the 2-coloured directed 4-cycle.

With any colour a , we associate $k-1$ such bits (one for each other colour).

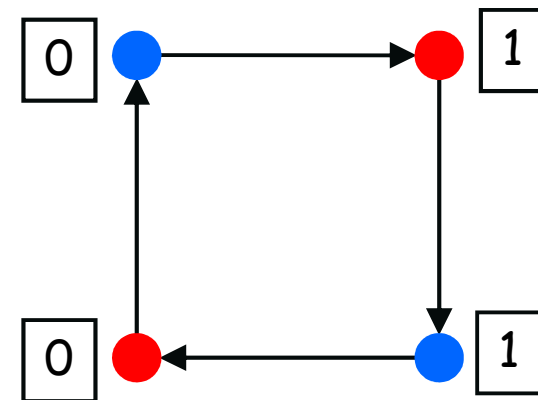

Graphs with bounded acyclic chromatic number

- **Theorem.** If G has acyclic chromatic number at most k , then

$$\chi_o(G) \leq k \cdot 2^{k-1}$$

(Raspaud, S., 1994)

Sketch of proof.

Doing that, we have constructed a homomorphism from $H_{a,b}$ to the 2-coloured directed 4-cycle.

With any colour a , we associate $k-1$ such bits (one for each other colour).

We thus obtain an oriented colouring of H using at most $k \cdot 2^{k-1}$ colours.

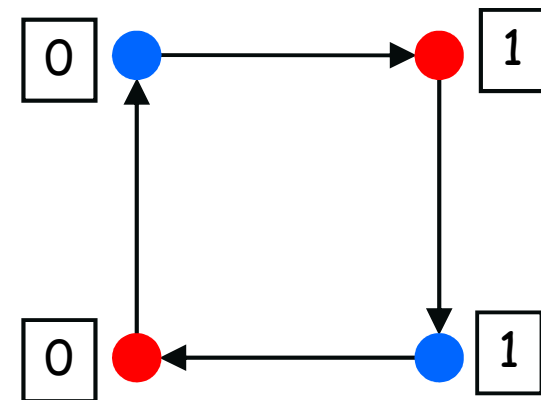

Planar graphs

The **girth** $g(G)$ of G is the size of a *shortest* cycle in G .

χ_0 of some graph classes

(3)

Planar graphs

The **girth** $g(G)$ of G is the size of a *shortest* cycle in G .

➤ The best known results are as follows:

girth	lower bound	upper bound	
≥ 3	18	80	Marshall, 2012 – Raspaud, S., 1994
≥ 4	11	40	Ochem, 2004 – Ochem, Pinlou, 2011
≥ 5	7	16	Marshall, 2012 – Pinlou, 2009
≥ 6	7	11	id. – Borodin, Kostochka, Nešetřil, Raspaud, S., 1999
≥ 7	6	7	Nešetřil, Raspaud, S., 1997 – Borodin, Ivanova, 2005
≥ 8	5	7	Nešetřil, Raspaud, S., 1997 – Borodin, Ivanova, 2005
≥ 9	5	6	Nešetřil, Raspaud, S., 1997 – Marshall, 2015
≥ 12	5	5	Nešetřil, Raspaud, S., 1997 – Borodin, Ivanova, Kostochka, 2007

Halin graphs

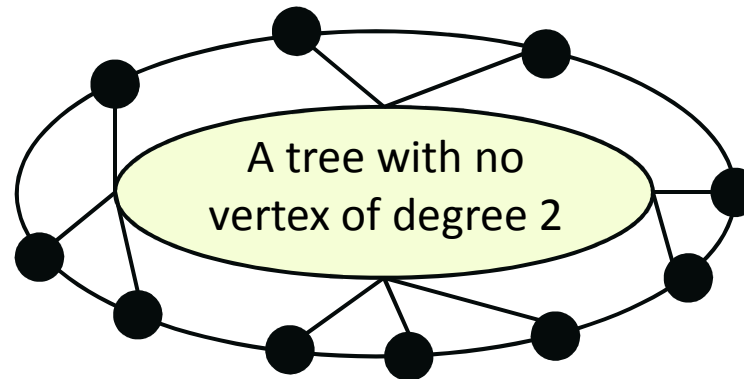

Halin graphs

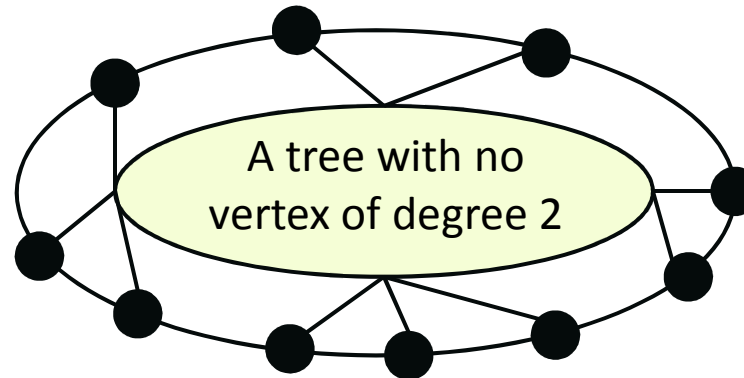

- **Theorem.** Every Halin graph G satisfies $\chi_o(G) \leq 8$ (*tight bound*)
(Dybizbański, Szepietowski, 2014)

Halin graphs

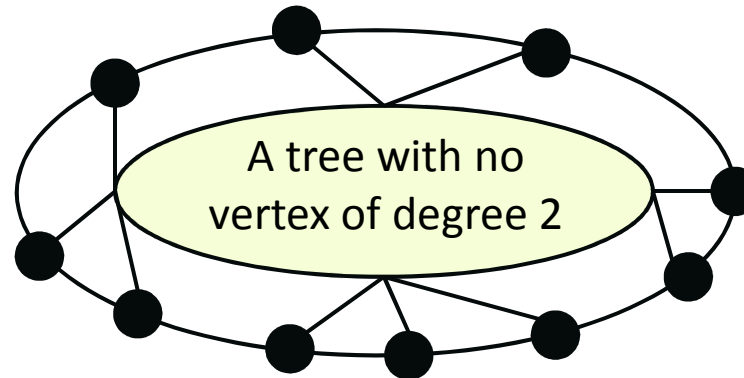

- **Theorem.** Every Halin graph G satisfies $\chi_o(G) \leq 8$ (*tight bound*)
(Dybizbański, Szepietowski, 2014)

Square grids

- **Theorem.** For every integers m and n , $\chi_o(P_m \square P_n) \leq 11$
(Fertin, Raspaud, Roychowdhury, 2003)

Halin graphs

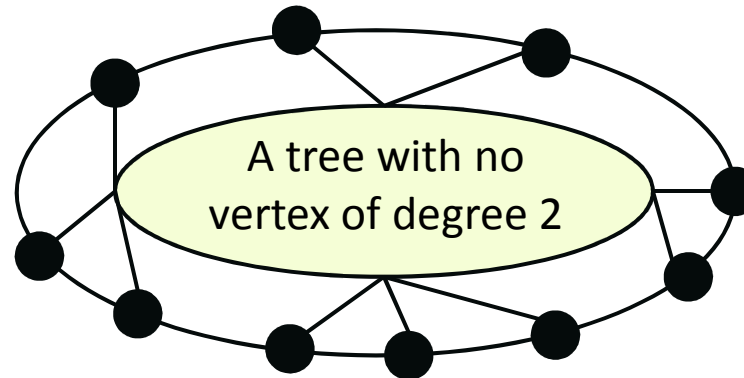

- **Theorem.** Every Halin graph G satisfies $\chi_o(G) \leq 8$ (*tight bound*)
(Dybizbański, Szepietowski, 2014)

Square grids

- **Theorem.** For every integers m and n , $\chi_o(P_m \square P_n) \leq 11$
(Fertin, Raspaud, Roychowdhury, 2003)

$$\chi_o(P_7 \square P_{212}) \geq 8 \quad \text{(Dybizbański, Nenca, 2012)}$$

Graphs with bounded degree

- Every graph G with **maximum degree 2**, except the directed cycle on 5 vertices, satisfies $\chi_0(G) \leq 4$ (easy)

Graphs with bounded degree

- Every graph G with **maximum degree 2**, except the directed cycle on 5 vertices, satisfies $\chi_o(G) \leq 4$ (easy)
- **Theorem.** If G is a graph with **maximum degree 3**, then $\chi_o(G) \leq 9$ (Duffy, 2014+)

Graphs with bounded degree

- Every graph G with **maximum degree 2**, except the directed cycle on 5 vertices, satisfies $\chi_o(G) \leq 4$ (easy)
- **Theorem.** If G is a graph with **maximum degree 3**, then $\chi_o(G) \leq 9$

(Duffy, 2014+)

There exist such graphs with oriented chromatic number 7:

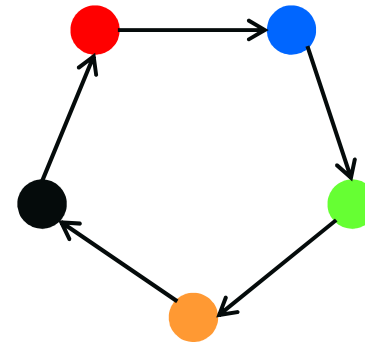

Graphs with bounded degree

- Every graph G with **maximum degree 2**, except the directed cycle on 5 vertices, satisfies $\chi_o(G) \leq 4$ (easy)
- **Theorem.** If G is a graph with **maximum degree 3**, then $\chi_o(G) \leq 9$

(Duffy, 2014+)

There exist such graphs with oriented chromatic number 7:

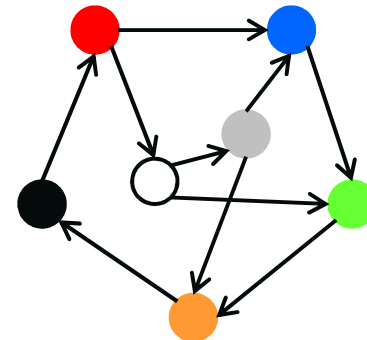

Graphs with bounded degree

- Every graph G with **maximum degree 2**, except the directed cycle on 5 vertices, satisfies $\chi_o(G) \leq 4$ (easy)
- **Theorem.** If G is a graph with **maximum degree 3**, then $\chi_o(G) \leq 9$

(Duffy, 2014+)

There exist such graphs with oriented chromatic number 7:

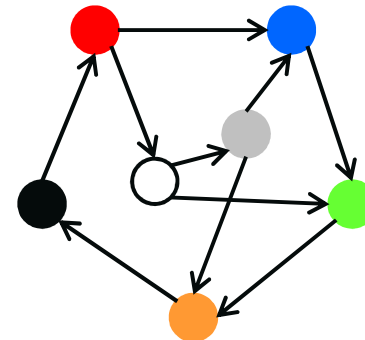

- **Conjecture.** If G is a **connected** cubic graph, then $\chi_o(G) \leq 7$.

(S., 1997)

Graphs with bounded degree

- Every graph G with **maximum degree 2**, except the directed cycle on 5 vertices, satisfies $\chi_o(G) \leq 4$ (easy)
- **Theorem.** If G is a graph with **maximum degree 3**, then $\chi_o(G) \leq 9$ (Duffy, 2014+)

There exist such graphs with oriented chromatic number 7:

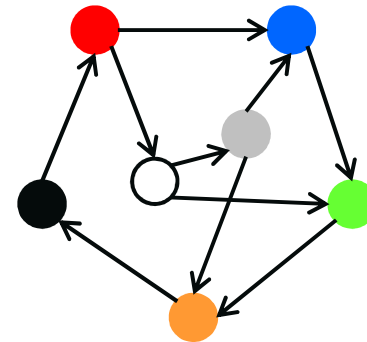

- **Conjecture.** If G is a **connected** cubic graph, then $\chi_o(G) \leq 7$. (S., 1997)
- **Theorem.** If G is a graph with **maximum degree 4**, then $\chi_o(G) \leq 67$ (best known lower bound is 12) (Duffy, 2014+)

Oriented cliques (o-cliques)

(1)

A well-known fact is that the (ordinary) chromatic number $\chi(G)$ of an undirected graph G is bounded from below by the clique number $\omega(G)$ of G (maximum order of a clique in G): $\chi(G) \geq \omega(G)$.

Oriented cliques (o-cliques)

(1)

A well-known fact is that the (ordinary) chromatic number $\chi(G)$ of an undirected graph G is bounded from below by the clique number $\omega(G)$ of G (maximum order of a clique in G): $\chi(G) \geq \omega(G)$.

Of course, a similar relation holds for oriented graphs...

Oriented cliques (o-cliques)

(1)

A well-known fact is that the (ordinary) chromatic number $\chi(G)$ of an undirected graph G is bounded from below by the clique number $\omega(G)$ of G (maximum order of a clique in G): $\chi(G) \geq \omega(G)$.

Of course, a similar relation holds for oriented graphs...

Oriented cliques

An **oriented clique** C is an oriented graph satisfying $\chi_o(C) = |V(C)|$.

Oriented cliques (o-cliques)

(1)

A well-known fact is that the (ordinary) chromatic number $\chi(G)$ of an undirected graph G is bounded from below by the clique number $\omega(G)$ of G (maximum order of a clique in G): $\chi(G) \geq \omega(G)$.

Of course, a similar relation holds for oriented graphs...

Oriented cliques

An **oriented clique** C is an oriented graph satisfying $\chi_o(C) = |V(C)|$.

Examples.

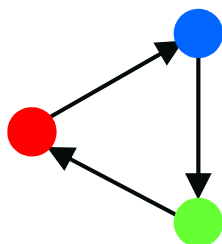

(all tournaments)

Oriented cliques (o-cliques)

(1)

A well-known fact is that the (ordinary) chromatic number $\chi(G)$ of an undirected graph G is bounded from below by the clique number $\omega(G)$ of G (maximum order of a clique in G): $\chi(G) \geq \omega(G)$.

Of course, a similar relation holds for oriented graphs...

Oriented cliques

An **oriented clique** C is an oriented graph satisfying $\chi_o(C) = |V(C)|$.

Examples.

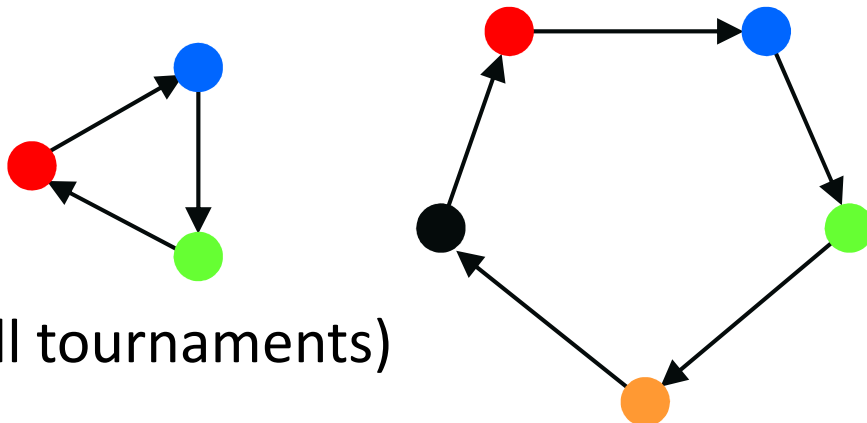

(all tournaments)

Oriented cliques (o-cliques)

(1)

A well-known fact is that the (ordinary) chromatic number $\chi(G)$ of an undirected graph G is bounded from below by the clique number $\omega(G)$ of G (maximum order of a clique in G): $\chi(G) \geq \omega(G)$.

Of course, a similar relation holds for oriented graphs...

Oriented cliques

An **oriented clique** C is an oriented graph satisfying $\chi_o(C) = |V(C)|$.

Examples.

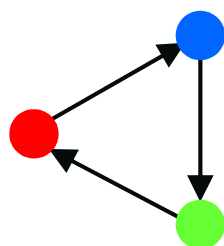

(all tournaments)

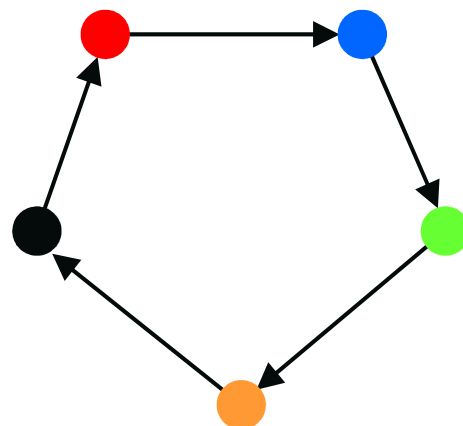

Remark. An o-clique is nothing but an oriented graph in which any two vertices are linked by a directed path (in any direction) of length at most 2.

Oriented cliques (o-cliques)

(2)

Building oriented o-cliques of order $2^k - 1$

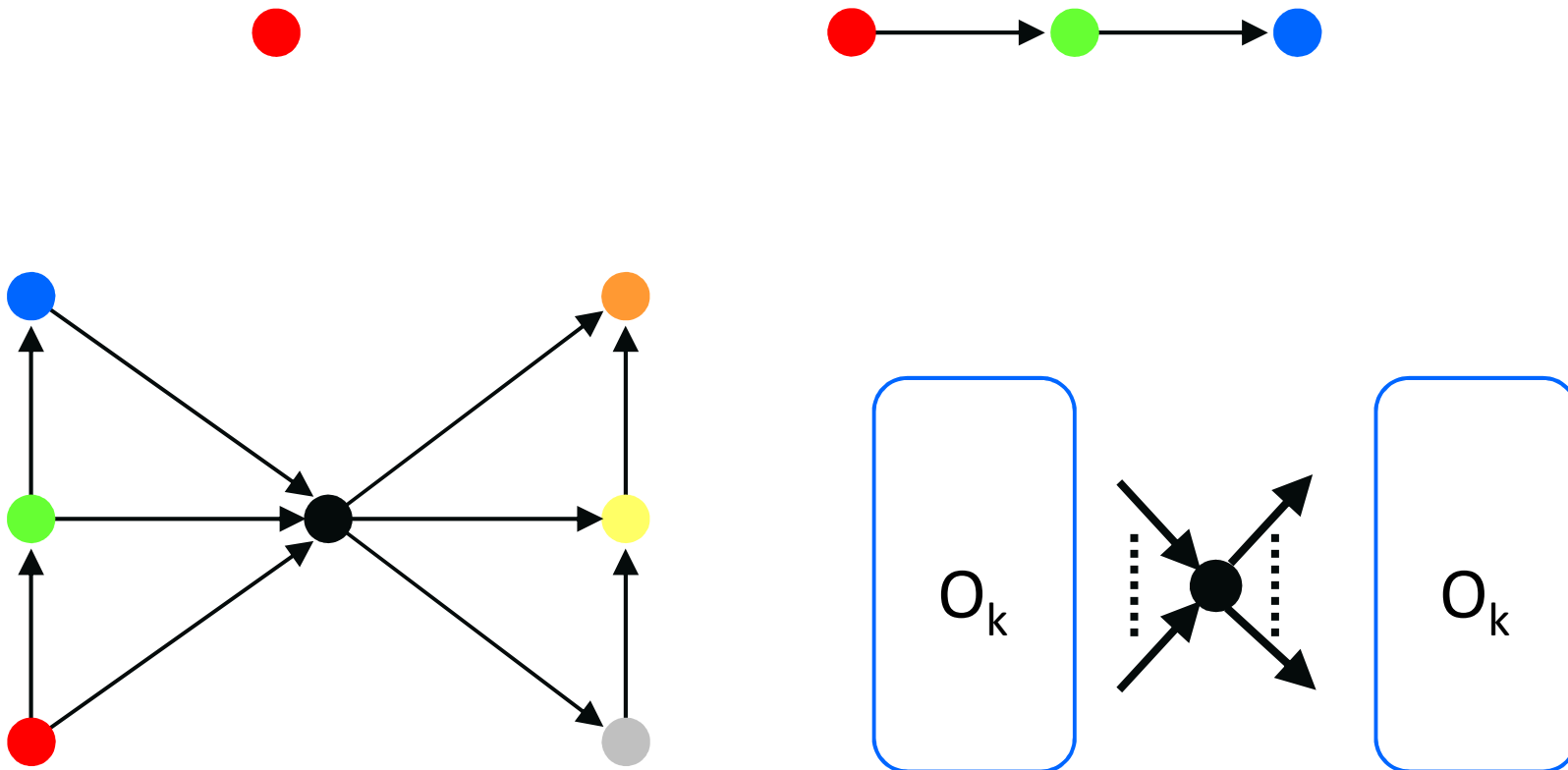

Structural properties of o-cliques

- **Theorem.** The minimum number of edges in an o-clique of order n is $(1 + o(1))n \log_2 n$.

(Füredi, Horak, Parrek, Zhu, 1998 – Kostochka, Łuczak, Simonyi, S., 1999)

Structural properties of o-cliques

- **Theorem.** The minimum number of edges in an o-clique of order n is $(1 + o(1))n \log_2 n$.

(Füredi, Horak, Parrek, Zhu, 1998 – Kostochka, Łuczak, Simonyi, S., 1999)

- **Theorem.** The order of a *planar* o-clique is at most 36.

(Klostermeyer, MacGillivray, 2002)

Structural properties of o-cliques

- **Theorem.** The minimum number of edges in an o-clique of order n is $(1 + o(1))n \log_2 n$.

(Füredi, Horak, Parrek, Zhu, 1998 – Kostochka, Łuczak, Simonyi, S., 1999)

- **Theorem.** The order of a *planar* o-clique is at most 36.

(Klostermeyer, MacGillivray, 2002)

- **Conjecture.** The maximum order of a *planar* o-clique is 15.

(id.)

Structural properties of o-cliques

- **Theorem.** The minimum number of edges in an o-clique of order n is $(1 + o(1))n \log_2 n$.
(Füredi, Horak, Parrek, Zhu, 1998 – Kostochka, Łuczak, Simonyi, S., 1999)
- **Theorem.** The order of a *planar* o-clique is at most 36.
(Klostermeyer, MacGillivray, 2002)
- **Theorem.** The maximum order of a *planar* o-clique is 15.
(Sen, 2012)

Structural properties of o-cliques

- **Theorem.** The minimum number of edges in an o-clique of order n is $(1 + o(1))n \log_2 n$.

(Füredi, Horak, Parrek, Zhu, 1998 – Kostochka, Łuczak, Simonyi, S., 1999)

- **Theorem.** The order of a *planar* o-clique is at most 36.

(Klostermeyer, MacGillivray, 2002)

- **Theorem.** The maximum order of a *planar* o-clique is 15.

(Sen, 2012)

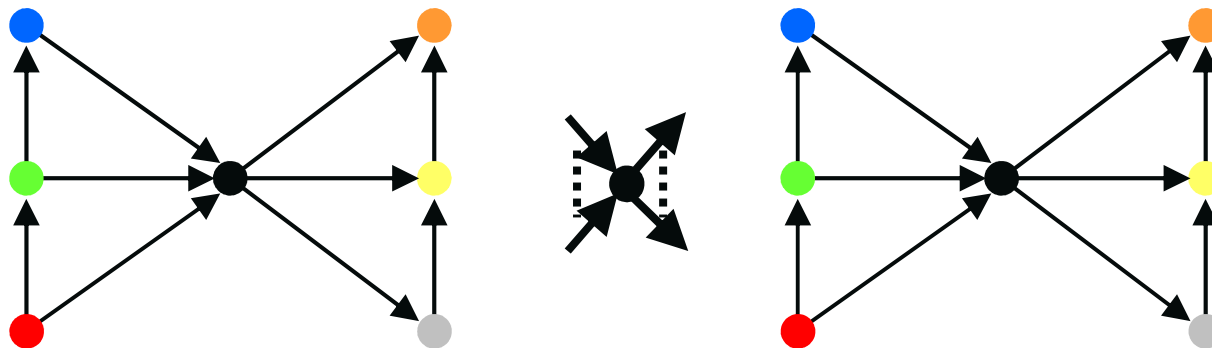

Oriented clique numbers...

(1)

The oriented clique number of an oriented graph may be defined in two different ways...

Oriented clique numbers...

(1)

The oriented clique number of an oriented graph may be defined in two different ways...

Absolute oriented clique number

The **absolute oriented clique number** $\omega_{ao}(G)$ of an oriented graph G is the maximum order of an o-clique subgraph of G .

Oriented clique numbers...

(1)

The oriented clique number of an oriented graph may be defined in two different ways...

Absolute oriented clique number

The **absolute oriented clique number** $\omega_{ao}(G)$ of an oriented graph G is the maximum order of an o-clique subgraph of G .

Relative oriented clique number

The **relative oriented clique number** $\omega_{ro}(G)$ of an oriented graph G is the maximum size of a subset S of $V(G)$ satisfying: every two vertices in S are linked (in G) by a directed path *of length at most 2*.

Oriented clique numbers...

(1)

The oriented clique number of an oriented graph may be defined in two different ways...

Absolute oriented clique number

The **absolute oriented clique number** $\omega_{ao}(G)$ of an oriented graph G is the maximum order of an o-clique subgraph of G .

Relative oriented clique number

The **relative oriented clique number** $\omega_{ro}(G)$ of an oriented graph G is the maximum size of a subset S of $V(G)$ satisfying: every two vertices in S are linked (in G) by a directed path *of length at most 2*.

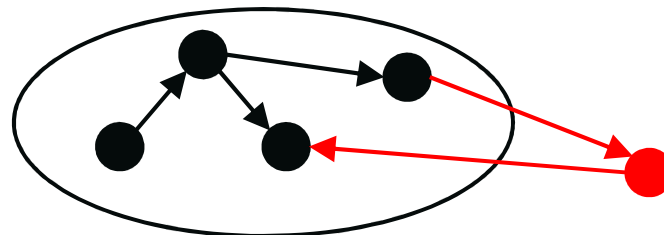

Oriented clique numbers...

(2)

Example.

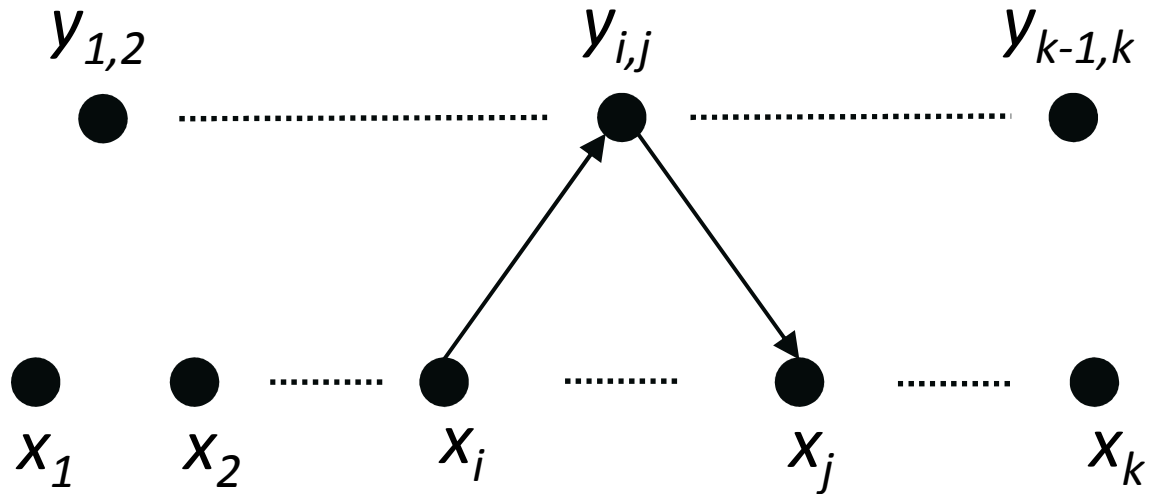

Oriented clique numbers...

(2)

Example.

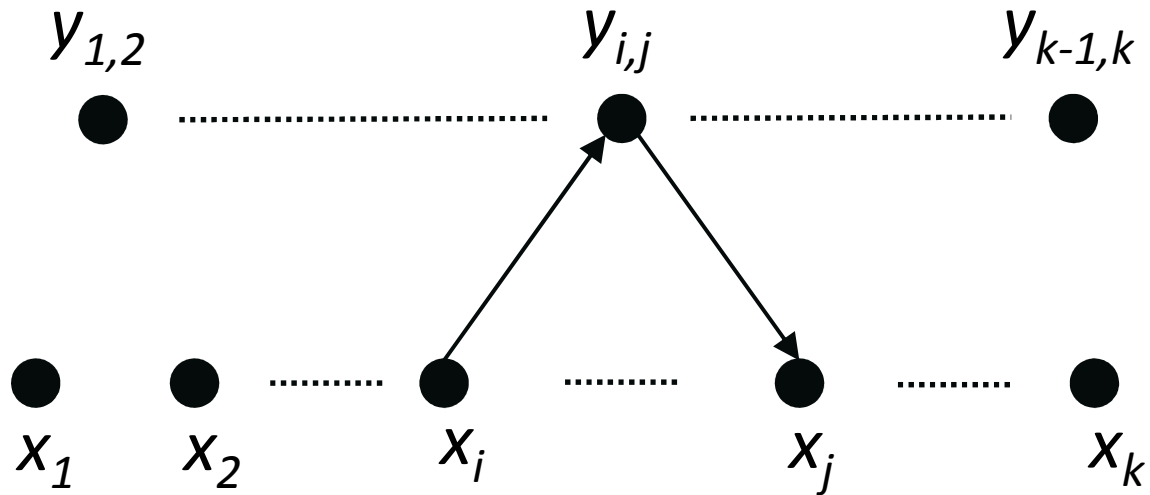

$$\omega_{ao} = 3$$

$$\omega_{ro} = k$$

Oriented clique numbers...

(2)

Example.

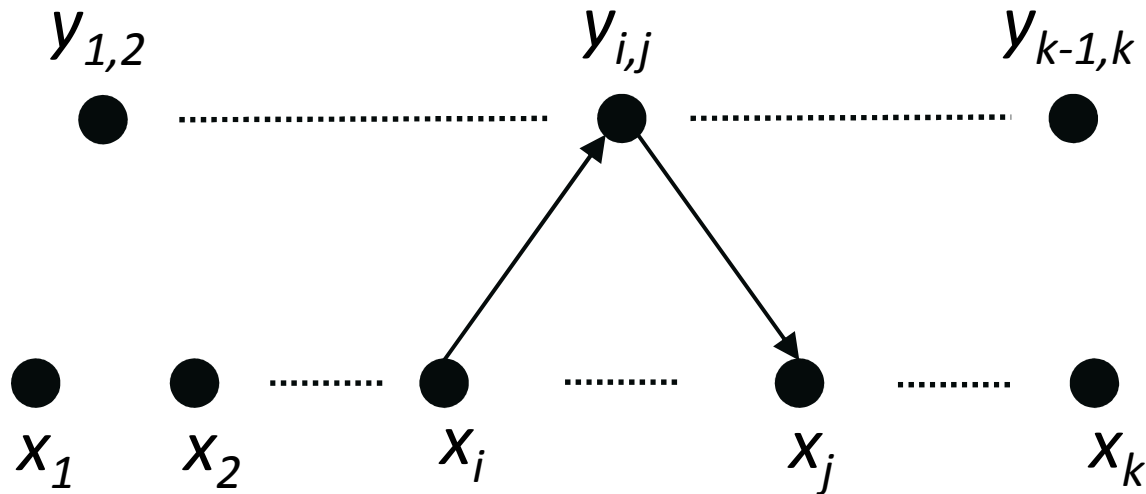

$$\omega_{ao} = 3$$

$$\omega_{ro} = k$$

Clearly, for every oriented graph G , we have:

$$\omega_{ao}(G) \leq \omega_{ro}(G) \leq \chi_o(G)$$

Oriented clique numbers...

(3)

For planar graphs with given girth, the following is known:

girth	ω_{ao}	ω_{ro}
3	15	$15 \leq \dots \leq 80$
4	6	$10 \leq \dots \leq 26$
5	5	6
6	3	4
≥ 7	3	3

(Sen, 2013+)

(Nandy, Sen, S., 2014+)

Complexity issues

(1)

Consider the following decision problem:

OCN_k : oriented k -colorability
INSTANCE: an oriented graph G
QUESTION: do we have $\chi_o(G) \leq k$?

Consider the following decision problem:

OCN_k : oriented k -colorability
INSTANCE: an oriented graph G
QUESTION: do we have $\chi_o(G) \leq k$?

We have the following:

➤ **Theorem.** OCN_k is polynomial if $k \leq 3$ and NP-complete if $k \geq 4$.

(Klostermeyer, MacGillivray, 2002)

Complexity issues

(1)

Consider the following decision problem:

OCN_k : oriented k -colorability
INSTANCE: an oriented graph G
QUESTION: do we have $\chi_o(G) \leq k$?

We have the following:

- **Theorem.** OCN_k is polynomial if $k \leq 3$ and NP-complete if $k \geq 4$.

(Klostermeyer, MacGillivray, 2002)

And even more:

- **Theorem.** OCN_4 is NP-complete for bounded degree bipartite, or bounded degree acyclic oriented graphs

(Culus, Demange, 2006 – Ganian and Hliněný, 2010)

Complexity issues

(1)

Consider the following decision problem:

OCN_k : oriented k -colorability
INSTANCE: an oriented graph G
QUESTION: do we have $\chi_o(G) \leq k$?

We have the following:

- **Theorem.** OCN_k is polynomial if $k \leq 3$ and NP-complete if $k \geq 4$.

(Klostermeyer, MacGillivray, 2002)

And even more:

- **Theorem.** OCN_4 is NP-complete for bounded degree bipartite, or bounded degree acyclic oriented graphs

(Culus, Demange, 2006 – Ganian and Hliněný, 2010)

- **Theorem.** OCN_4 is NP-complete for connected, cubic, planar, bipartite and acyclic oriented graphs (Coehlo, Faria, Gravier, Klein, 2013)

Even even more:

- **Theorem.** For every fixed $g \geq 3$, ocN_4 is NP-complete for oriented graphs that are planar, with girth at most g , bipartite, subcubic, with DAG-depth 3, with maximum outdegree 2 and maximum indegree 2, and such that every 3-vertex is adjacent to at most one 3-vertex!

(Guegan, Ochem, 2014+)

Even even more:

- **Theorem.** For every fixed $g \geq 3$, ocN_4 is NP-complete for oriented graphs that are planar, with girth at most g , bipartite, subcubic, with DAG-depth 3, with maximum outdegree 2 and maximum indegree 2, and such that every 3-vertex is adjacent to at most one 3-vertex!

(Guegan, Ochem, 2014+)

- **Remark.** It is *polynomial* to decide whether an oriented graph admits a homomorphism to a tournament T of order 4, except when T is the following (contains a directed cycle of length 4):

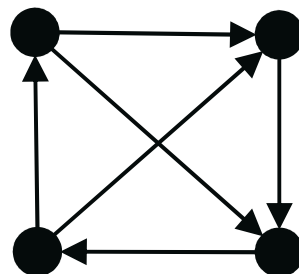

Another related problem:

OWD_k : orientation with weak diameter k

INSTANCE: an undirected graph U

QUESTION: does U admit an orientation with weak diameter k ?

weak distance: $d_w(u,v) = \min \{ d(u,v), d(v,u) \}$

Another related problem:

OWD_k : orientation with weak diameter k

INSTANCE: an undirected graph U

QUESTION: does U admit an orientation with weak diameter k ?

weak distance: $d_w(u,v) = \min \{ d(u,v), d(v,u) \}$

➤ **Theorem.** OWD_k is NP-complete if $k \geq 2$.

(Bensmail, Duvignau, Kirgizov, 2013+)

Another related problem:

OWD_k : orientation with weak diameter k

INSTANCE: an undirected graph U

QUESTION: does U admit an orientation with weak diameter k ?

weak distance: $d_w(u,v) = \min \{ d(u,v), d(v,u) \}$

➤ **Theorem.** OWD_k is NP-complete if $k \geq 2$.

(Bensmail, Duvignau, Kirgizov, 2013+)

➤ **Corollary.** It is NP-complete to decide whether an undirected graph U admits an orientation which is an o-clique...

Simple colourings

(1)

(Recall that) An oriented k -colouring of an oriented G is a partition of $V(G)$ into k independent sets in such a way that all the arcs joining any two such sets have the same direction:

Simple colourings

(1)

(Recall that) An oriented k -colouring of an oriented G is a partition of $V(G)$ into k independent sets in such a way that all the arcs joining any two such sets have the same direction:

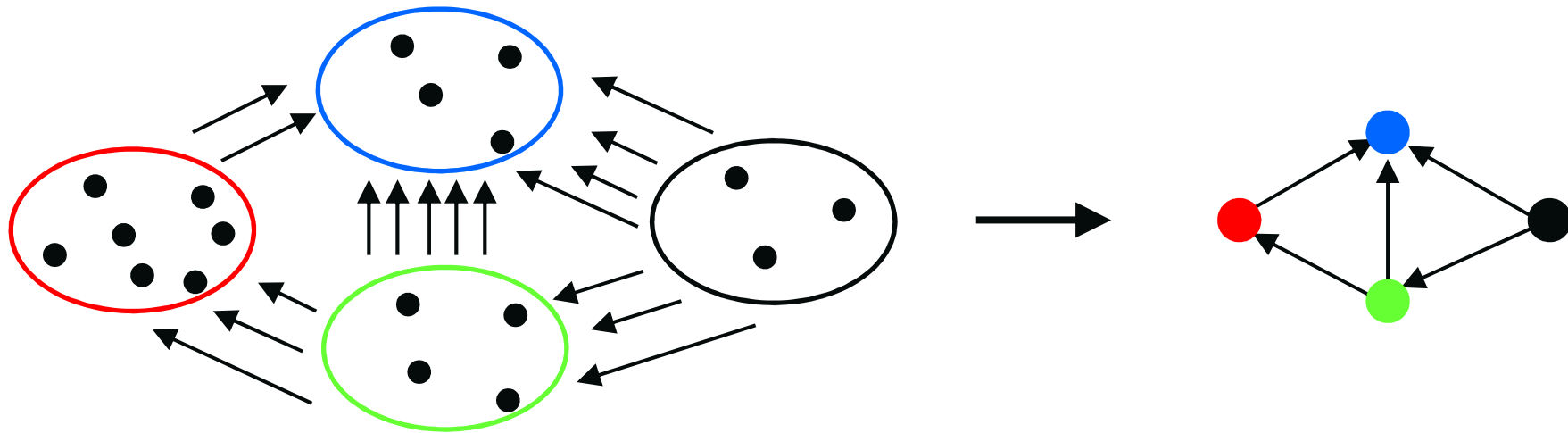

Simple colourings

(1)

(Recall that) An oriented k -colouring of an oriented G is a partition of $V(G)$ into k independent sets in such a way that all the arcs joining any two such sets have the same direction:

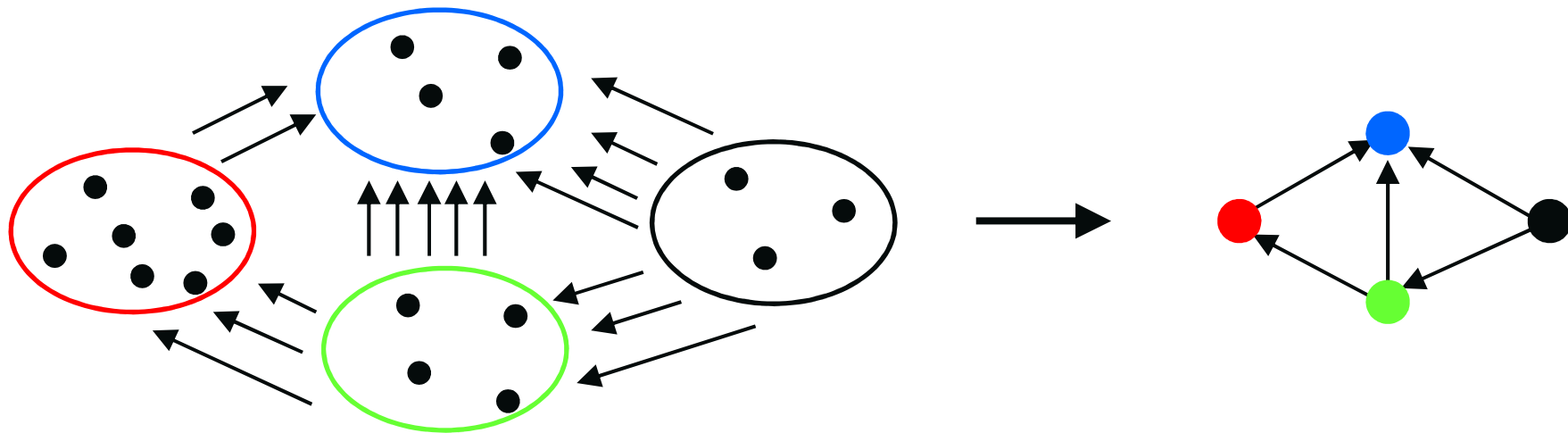

Simple colourings

- do not require the parts to be independent sets
- require at least two parts...

(Nešetřil, Smolíková, 2000)

Simple colourings

(1')

(Recall that) An oriented k -colouring of an oriented G is a partition of $V(G)$ into k independent sets in such a way that all the arcs joining any two such sets have the same direction:

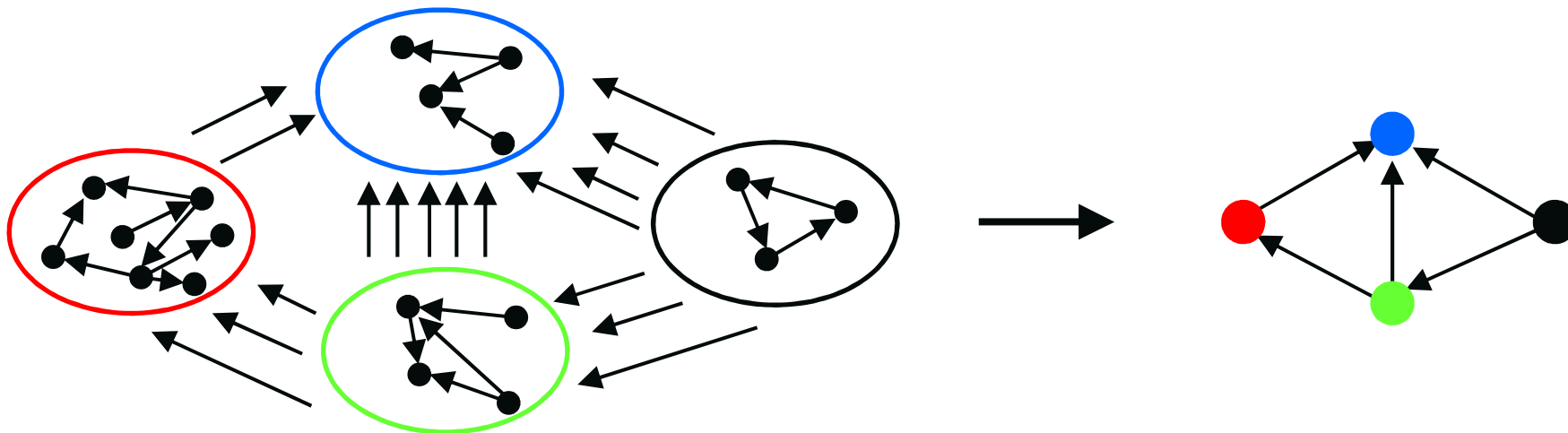

Simple colourings

- do not require the parts to be independent sets
- require at least two parts...

(Nešetřil, Smolíková, 2000)

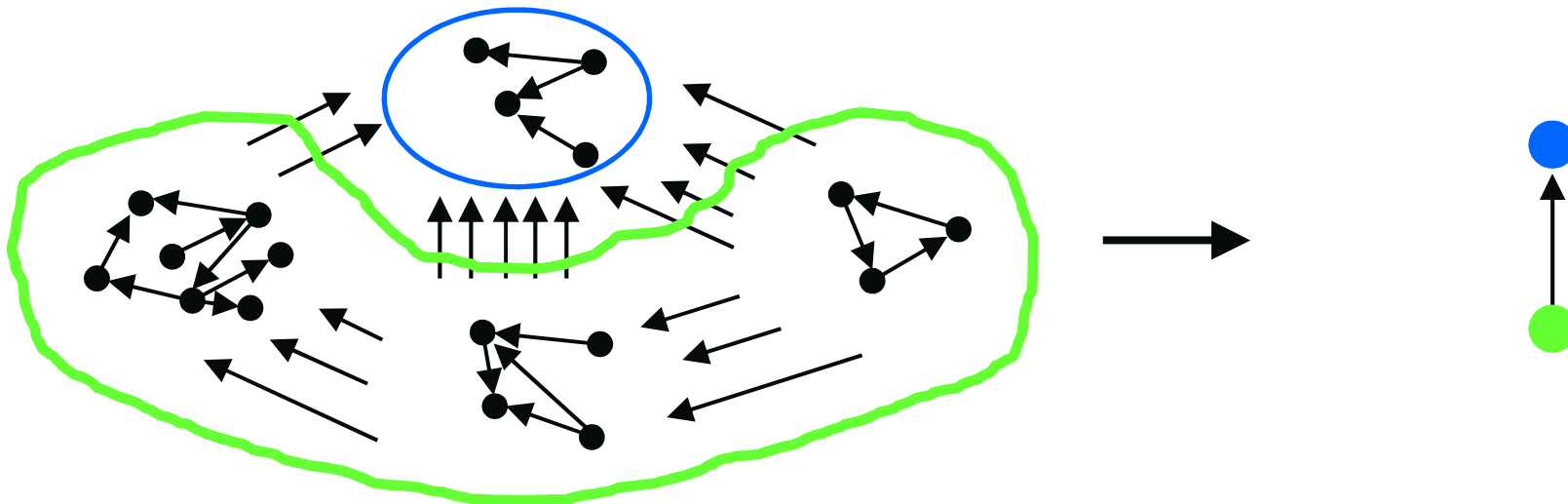

Simple colourings

- do not require the parts to be independent sets
- require at least two parts...

(Nešetřil, Smolíková, 2000)

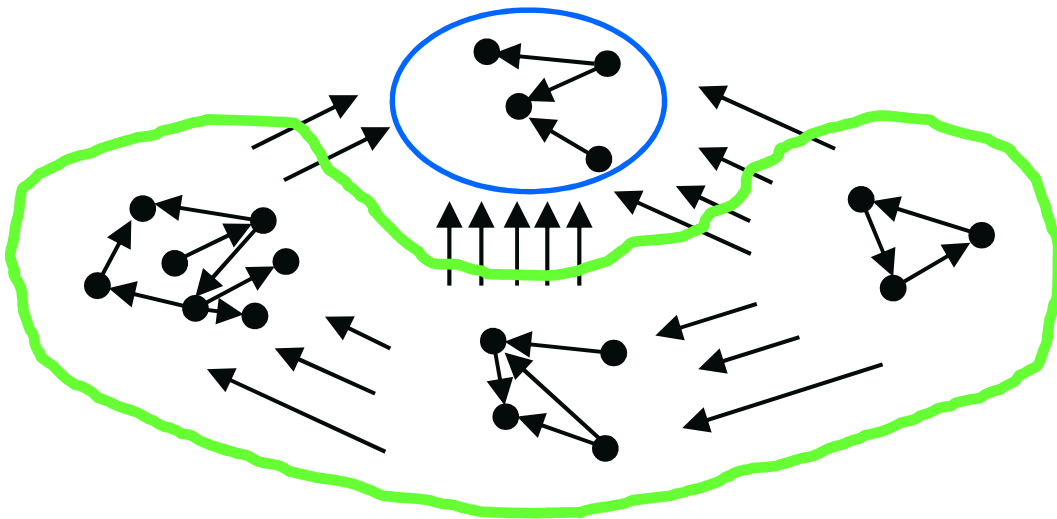

For every oriented graph G ,
 $\chi_s(G) \leq \chi_o(G)$

Simple colourings

- do not require the parts to be independent sets
- require at least two parts...

(Nešetřil, Smolíková, 2000)

Simple colourings

(2)

- **Theorem.** The maximum oriented chromatic number of planar graphs and the maximum simple chromatic number of planar graphs coincide... (Smolíková, 2000)

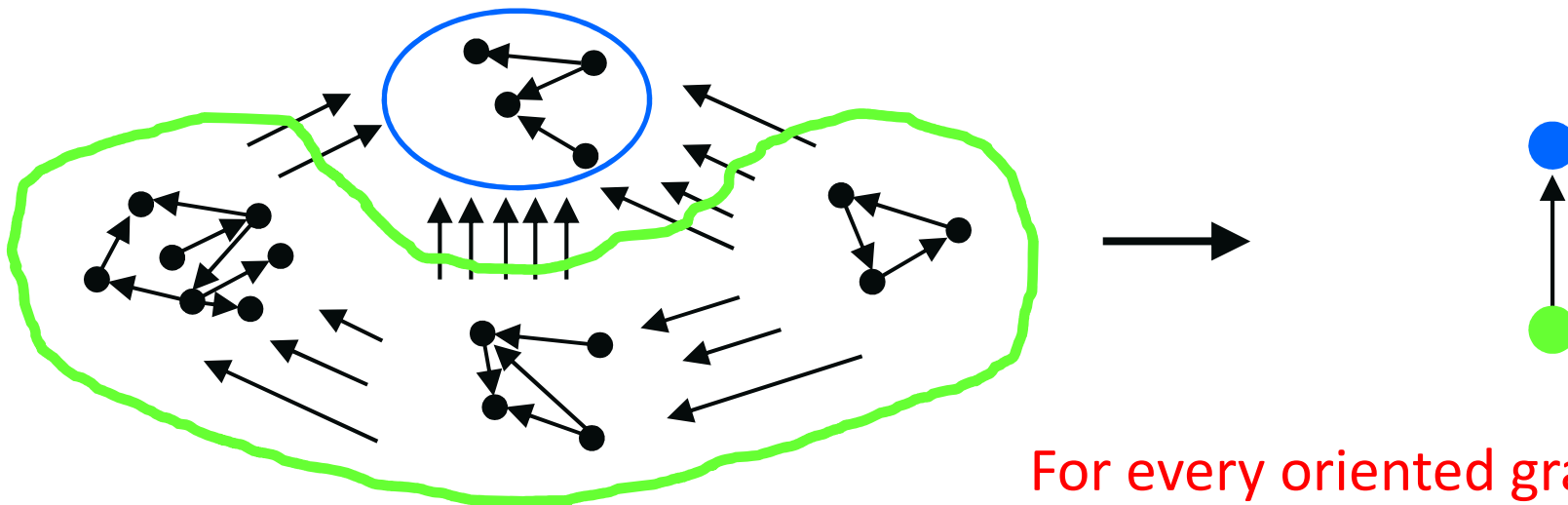

Simple colourings

For every oriented graph G ,
 $\chi_s(G) \leq \chi_o(G)$

- do not require the parts to be independent sets
- require at least two parts... (Nešetřil, Smolíková, 2000)

2-dipath colouring

(1)

In 2006, Chen and Wang introduced another weaker version of oriented colouring:

In 2006, Chen and Wang introduced another weaker version of oriented colouring:

2-dipath colouring

A **2-dipath k -colouring** of an oriented graph G is a mapping

$$c : V(G) \rightarrow \{1, 2, \dots, k\}$$

such that any two vertices linked by a **directed path of length 1 or 2** get distinct colours.

2-dipath colouring

(1)

In 2006, Chen and Wang introduced another weaker version of oriented colouring:

2-dipath colouring

A **2-dipath k -colouring** of an oriented graph G is a mapping

$$c : V(G) \rightarrow \{1, 2, \dots, k\}$$

such that any two vertices linked by a **directed path of length 1 or 2** get distinct colours.



2-dipath colouring

(1)

In 2006, Chen and Wang introduced another weaker version of oriented colouring:

2-dipath colouring

A **2-dipath k -colouring** of an oriented graph G is a mapping

$$c : V(G) \rightarrow \{1, 2, \dots, k\}$$

such that any two vertices linked by a **directed path of length 1 or 2** get distinct colours.

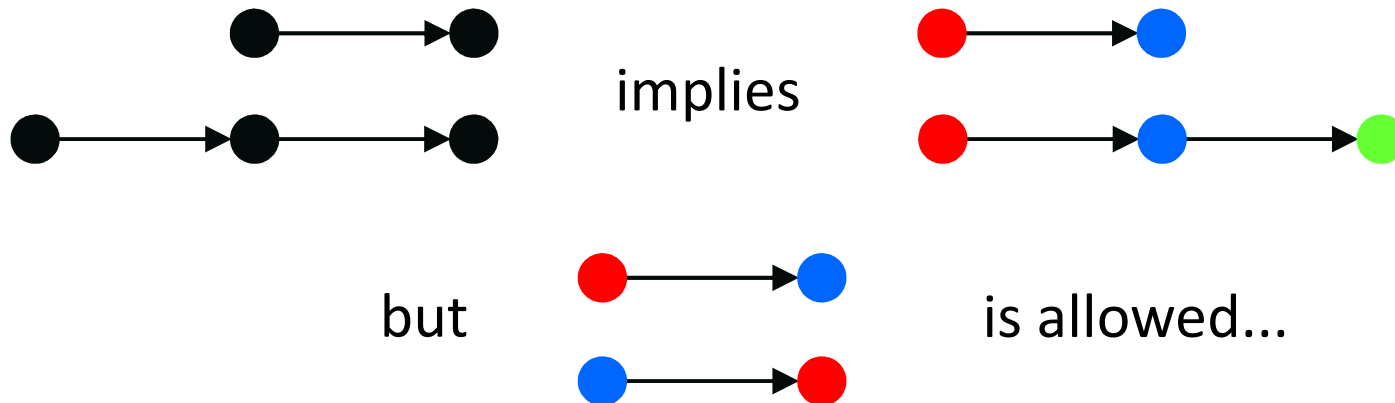

In 2006, Chen and Wang introduced another weaker version of oriented colouring:

2-dipath colouring

A **2-dipath k -colouring** of an oriented graph G is a mapping

$$c : V(G) \rightarrow \{1, 2, \dots, k\}$$

such that any two vertices linked by a **directed path of length 1 or 2** get distinct colours.

2-dipath chromatic number

The **2-dipath chromatic number** $\chi_{2d}(G)$ of an oriented graph G is the smallest k for which G admits a 2-dipath k -colouring.

2-dipath colouring

(2)

Remark. A 2-dipath colouring of an oriented graph G may also be viewed as a $L(1,1)$ -labelling of G (using directed distance).

2-dipath colouring

(2)

Remark. A 2-dipath colouring of an oriented graph G may also be viewed as a **L(1,1)-labelling** of G (using directed distance).

We have the following results:

➤ For every oriented graph G , $\chi_{2d}(G) \leq \chi_o(G)$ (definition)

2-dipath colouring

(2)

Remark. A 2-dipath colouring of an oriented graph G may also be viewed as a **L(1,1)-labelling** of G (using directed distance).

We have the following results:

- For every oriented graph G , $\chi_{2d}(G) \leq \chi_o(G)$ (definition)
- For every oriented graph G , $\chi_{2d}(G) \geq \omega_{ro}(G) \geq \omega_{ao}(G)$ (definition)

2-dipath colouring

(2)

Remark. A 2-dipath colouring of an oriented graph G may also be viewed as a $L(1,1)$ -labelling of G (using directed distance).

We have the following results:

- For every oriented graph G , $\chi_{2d}(G) \leq \chi_o(G)$ (definition)
- For every oriented graph G , $\chi_{2d}(G) \geq \omega_{ro}(G) \geq \omega_{ao}(G)$ (definition)

From these observations, we get:

- If G is an oriented outerplanar graph, then $\chi_{2d}(G) \leq 7$, and this bound is tight

(recall that there exists an outerplanar o-clique of order 7)

2-dipath colouring

(2)

Remark. A 2-dipath colouring of an oriented graph G may also be viewed as a $L(1,1)$ -labelling of G (using directed distance).

We have the following results:

- For every oriented graph G , $\chi_{2d}(G) \leq \chi_o(G)$ (definition)
- For every oriented graph G , $\chi_{2d}(G) \geq \omega_{ro}(G) \geq \omega_{ao}(G)$ (definition)

From these observations, we get:

- If G is an oriented outerplanar graph, then $\chi_{2d}(G) \leq 7$, and this bound is tight
(recall that there exists an outerplanar o-clique of order 7)
- If G is an oriented planar graph, then $\chi_{2d}(G) \leq 80$, and there exist planar graphs with 2-dipath chromatic number 15.

2-dipath colouring

(3)

- **Theorem.** If G is an oriented Halin graph, then $\chi_{2d}(G) \leq 7$ (and this bound is tight). (Chen, Wang, 2006)

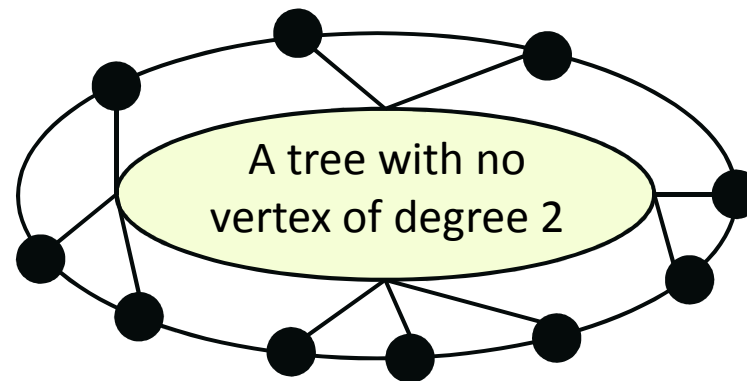

2-dipath colouring

(3)

- **Theorem.** If G is an oriented Halin graph, then $\chi_{2d}(G) \leq 7$ (and this bound is tight).
(Chen, Wang, 2006)

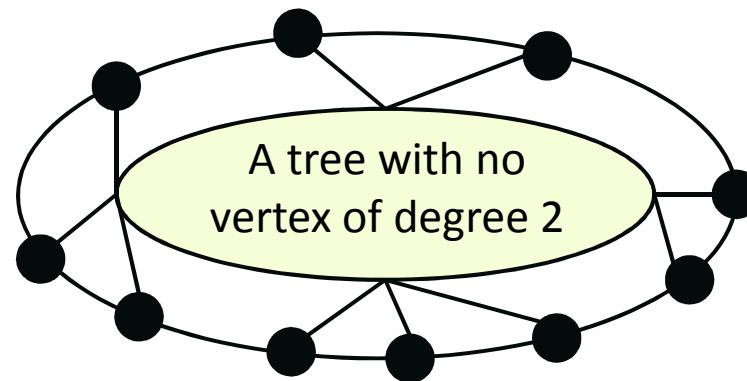

- **Theorem.** Determining whether an oriented graph is 2-dipath k -colourable is polynomial if $k \leq 2$ and NP-complete if $k \geq 3$
(MacGillivray, Sherk, 2014)

A homomorphism model

(1)

[MacGillivray, Sherk, 2014]

Let G_k , $k \geq 1$, be the oriented graph defined as follows:

$$\blacktriangleright V(G_k) = \{ (u_0 ; u_1, \dots, u_k) : 1 \leq u_0 \leq k, u_i \in \{+, -\} \text{ if } i \neq u_0, u_{u_0} = * \}$$

A homomorphism model

(1)

[MacGillivray, Sherk, 2014]

Let G_k , $k \geq 1$, be the oriented graph defined as follows:

$$\triangleright V(G_k) = \{ (u_0 ; u_1, \dots, u_k) : 1 \leq u_0 \leq k, u_i \in \{+, -\} \text{ if } i \neq u_0, u_{u_0} = * \}$$

Example. The oriented graph G_3 ($3 \cdot 2^2 = 12$ vertices)

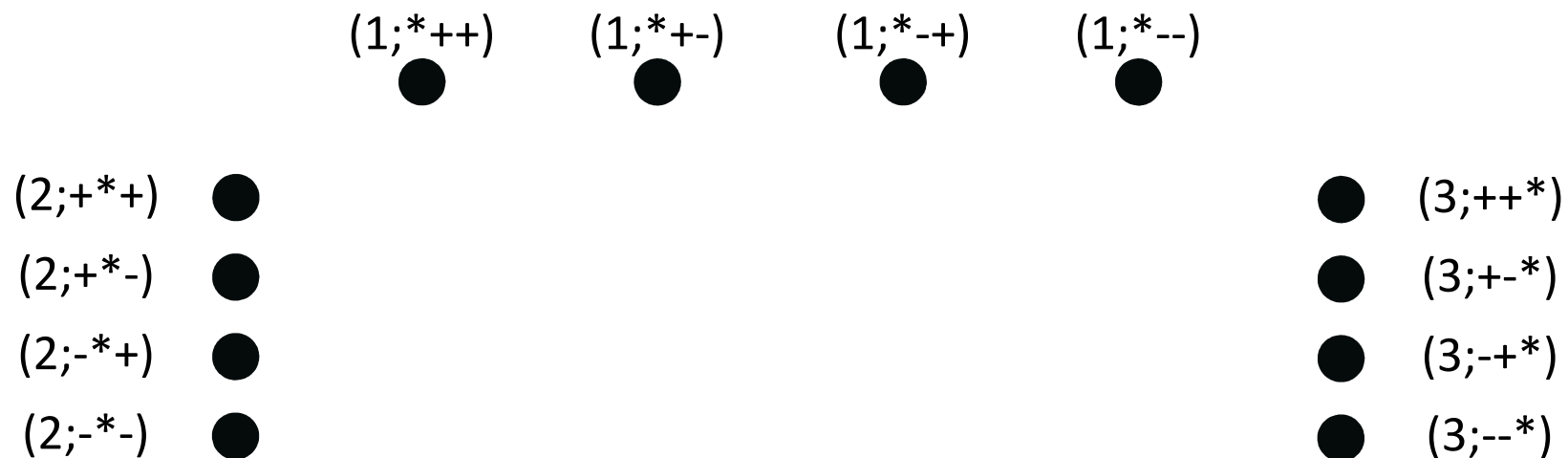

A homomorphism model

(1)

[MacGillivray, Sherk, 2014]

Let G_k , $k \geq 1$, be the oriented graph defined as follows:

- $V(G_k) = \{ (u_0; u_1, \dots, u_k) : 1 \leq u_0 \leq k, u_i \in \{+, -\} \text{ if } i \neq u_0, u_{u_0} = * \}$
- $E(G_k) = \{ (u_0; u_1, \dots, u_k)(v_0; v_1, \dots, v_k) : u_{v_0} = +, v_{u_0} = - \}$

Example. The oriented graph G_3 ($3 \cdot 2^2 = 12$ vertices)

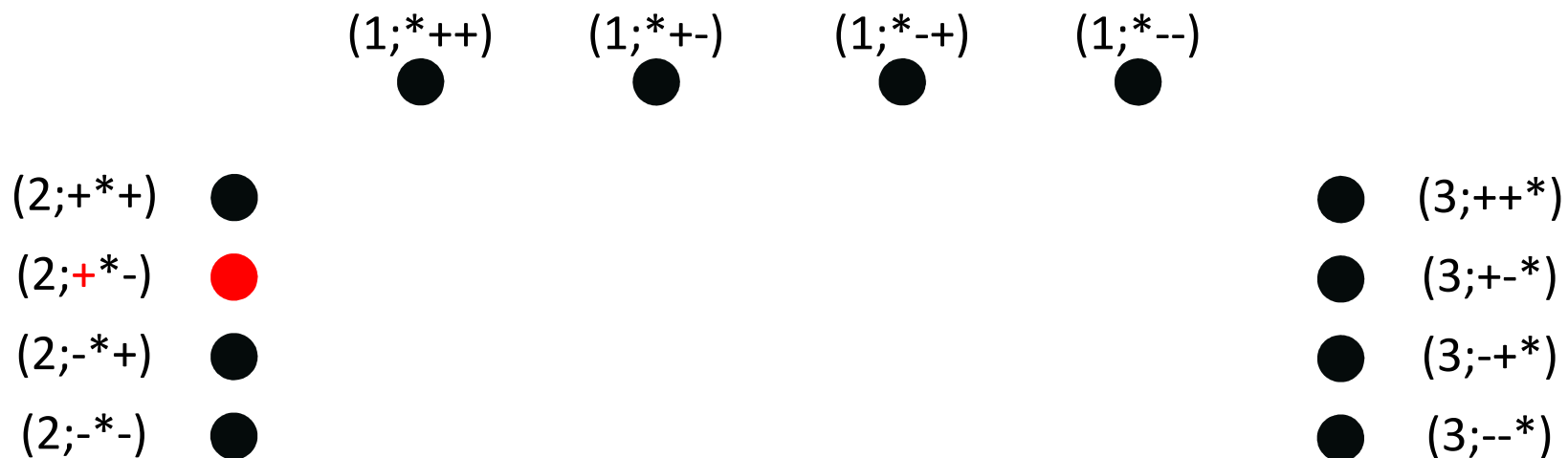

A homomorphism model

(1)

[MacGillivray, Sherk, 2014]

Let G_k , $k \geq 1$, be the oriented graph defined as follows:

- $V(G_k) = \{ (u_0; u_1, \dots, u_k) : 1 \leq u_0 \leq k, u_i \in \{+, -\} \text{ if } i \neq u_0, u_{u_0} = * \}$
- $E(G_k) = \{ (u_0; u_1, \dots, u_k)(v_0; v_1, \dots, v_k) : u_{v_0} = +, v_{u_0} = - \}$

Example. The oriented graph G_3 ($3 \cdot 2^2 = 12$ vertices)

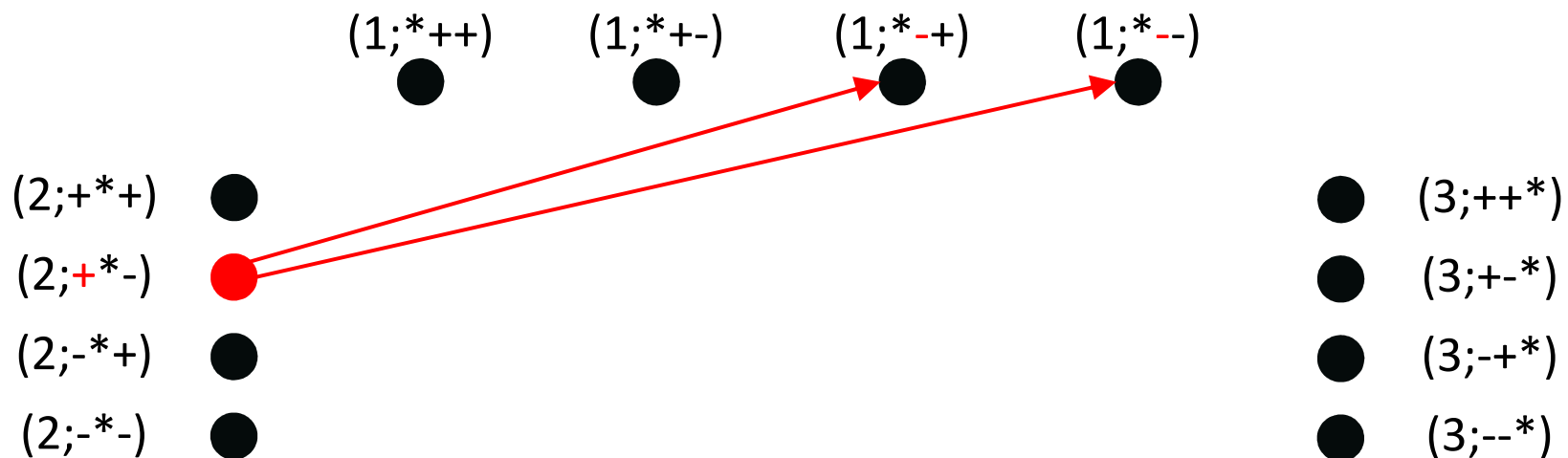

A homomorphism model

(1)

[MacGillivray, Sherk, 2014]

Let G_k , $k \geq 1$, be the oriented graph defined as follows:

- $V(G_k) = \{ (u_0; u_1, \dots, u_k) : 1 \leq u_0 \leq k, u_i \in \{+, -\} \text{ if } i \neq u_0, u_{u_0} = * \}$
- $E(G_k) = \{ (u_0; u_1, \dots, u_k)(v_0; v_1, \dots, v_k) : u_{v_0} = +, v_{u_0} = - \}$

Example. The oriented graph G_3 ($3 \cdot 2^2 = 12$ vertices)

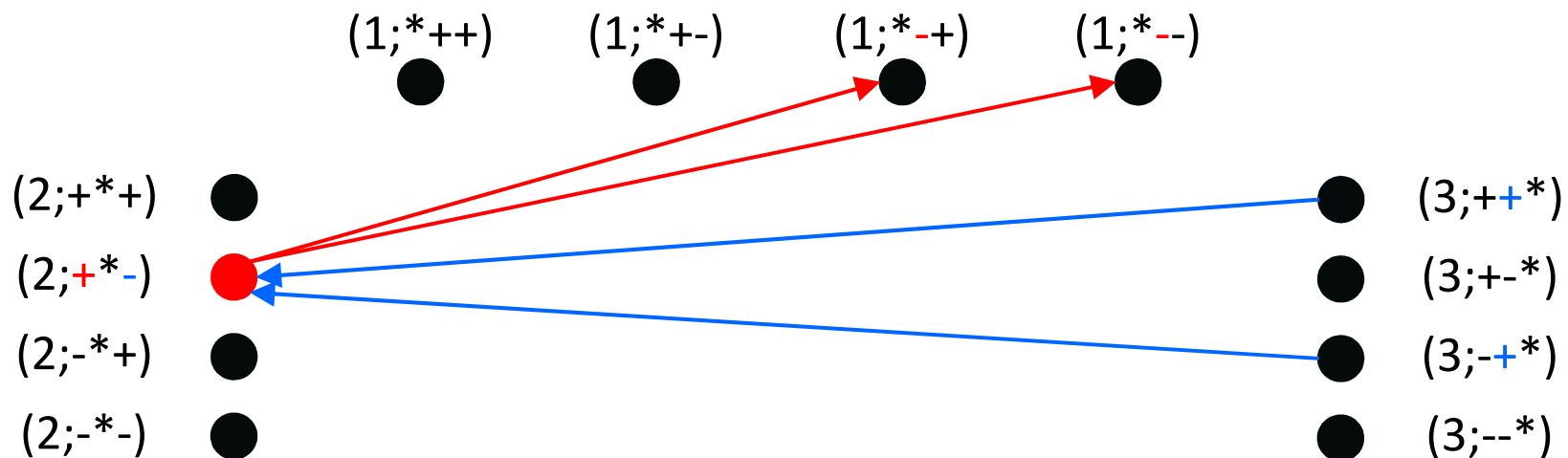

A homomorphism model

(2)

- **Theorem.** For every $k \geq 1$ and every oriented graph G ,
- $$\chi_{2d}(G) \leq k \text{ iff } G \rightarrow G_k$$

(MacGillivray, Sherk, 2014)

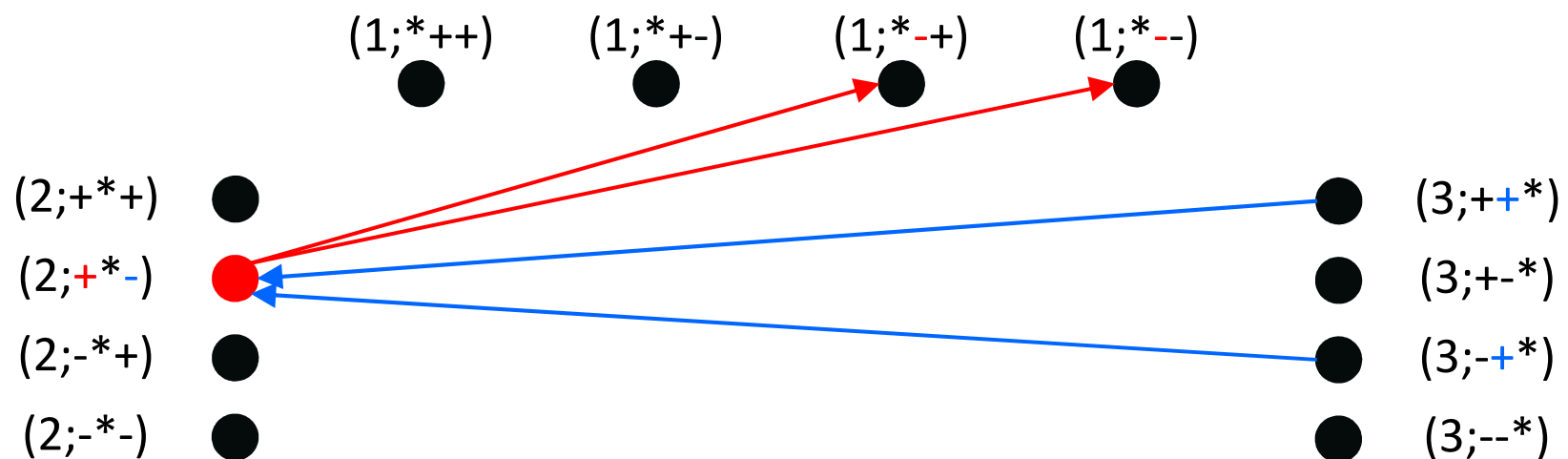

Some open problems...

(1)

Some open problems...

(1)

Open Problem A. Determine the maximum oriented chromatic number of connected graphs with degree at most 3 (*lies between 7 and 9, conjectured to be 7*).

Some open problems...

(1)

Open Problem A. Determine the maximum oriented chromatic number of connected graphs with degree at most 3 (*lies between 7 and 9, conjectured to be 7*).

Open Problem B. Determine the maximum oriented chromatic number of graphs with degree at most 4 (*lies between 12 and 67*).

Some open problems...

(1)

Open Problem A. Determine the maximum oriented chromatic number of connected graphs with degree at most 3 (*lies between 7 and 9, conjectured to be 7*).

Open Problem B. Determine the maximum oriented chromatic number of graphs with degree at most 4 (*lies between 12 and 67*).

Open Problem C. Determine the maximum oriented chromatic number of planar graphs (*lies between 18 and 80*).

Some open problems...

(1)

Open Problem A. Determine the maximum oriented chromatic number of connected graphs with degree at most 3 (*lies between 7 and 9, conjectured to be 7*).

Open Problem B. Determine the maximum oriented chromatic number of graphs with degree at most 4 (*lies between 12 and 67*).

Open Problem C. Determine the maximum oriented chromatic number of planar graphs (*lies between 18 and 80*).



Some open problems...

(1)

Open Problem A. Determine the maximum oriented chromatic number of connected graphs with degree at most 3 (*lies between 7 and 9, conjectured to be 7*).

Open Problem B. Determine the maximum oriented chromatic number of graphs with degree at most 4 (*lies between 12 and 67*).

Open Problem C. Determine the maximum oriented chromatic number of planar graphs (*lies between 18 and 80*).

Open Problem D. Determine the maximum oriented chromatic number of triangle-free planar graphs (*lies between 11 and 40*).

Some open problems...

(2)

Open Problem E. Determine the maximum oriented chromatic number of 2-dimensional grids (*lies between 8 and 11*).

Some open problems...

(2)

Open Problem E. Determine the maximum oriented chromatic number of 2-dimensional grids (*lies between 8 and 11*).

Open Problem F. Determine the maximum relative oriented clique number of planar graphs (*lies between 15 and 80*).

Some open problems...

(2)

Open Problem E. Determine the maximum oriented chromatic number of 2-dimensional grids (*lies between 8 and 11*).

Open Problem F. Determine the maximum relative oriented clique number of planar graphs (*lies between 15 and 80*).

Open Problem G. Determine the maximum relative oriented clique number of triangle-free planar graphs (*lies between 10 and 26*).

Some open problems...

(2)

Open Problem E. Determine the maximum oriented chromatic number of 2-dimensional grids (*lies between 8 and 11*).

Open Problem F. Determine the maximum relative oriented clique number of planar graphs (*lies between 15 and 80*).

Open Problem G. Determine the maximum relative oriented clique number of triangle-free planar graphs (*lies between 10 and 26*).

Open Problem H. Determine the maximum 2-dipath chromatic number of planar graphs (*again, lies between 18 and 80*).

E. Sopena. Homomorphisms and colourings of oriented graphs: An updated survey. *Discrete Math.*, available online (April 2015).



**Bordeaux Graphs Workshop
BGW'2016**
November 7-10, 2016



E. Sopena. Homomorphisms and colourings of oriented graphs: An updated survey. *Discrete Math.*, available online (April 2015).

T → H → A → N → K

Y → O → U



**Bordeaux Graphs Workshop
BGW'2016**
November 7-10, 2016



E. Sopena. Homomorphisms and colourings of oriented graphs: An updated survey. *Discrete Math.*, available online (April 2015).